

Block Clamps

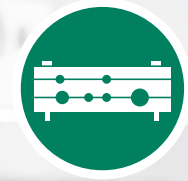

Special Clamps



Light Series



Saddle Clamps



U-Bolt Clamps



Metal Clamps

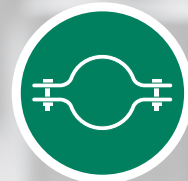

Construction Series



Germany

Walter Stauffenberg GmbH & Co. KG

Im Ehrenfeld 4
58791 Werdohl

www.stauff.com

STAUFF products and services are globally available through wholly-owned subsidiaries and a tight network of authorised distributors and representatives in all major industrial regions of the world.

You can find detailed contact information on the last two pages of this product catalogue or at www.stauff.com/contact.

Please note: Unless otherwise stated, all data and figures in this product catalogue are approximate values and are only valid as references, which are not binding (also in respect to any third parties' rights of protection) and thus do not release the customer / user from checking and testing the suitability of the products for the foreseen purposes. Therefore, data and figures can only be used in a limited sense for construction purposes.

The application of the products is beyond the control possibilities of the manufacturer and, therefore, is exclusively subject to the responsibility of the customer / user.

In the event that a liability is nevertheless considered, any compensation will be limited to the value of the goods supplied by the manufacturer and used by the customer / user. As a matter of course, the manufacturer guarantees the perfect quality of all products in accordance with the General Terms and Conditions of Business and Sale.

Subject to modifications due to the ongoing development and improvement of the products.

With the publication of this product catalogue, previous editions are no longer valid.

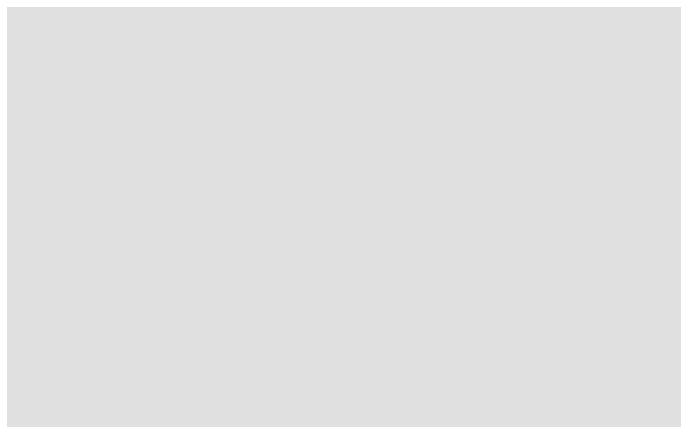
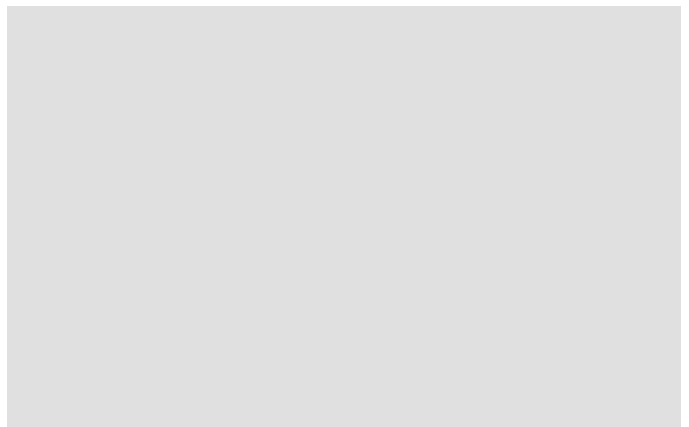

Introduction	4 - 11	
Standard Series according to DIN 3015, Part 1	12 - 33	A
Heavy Series according to DIN 3015, Part 2	34 - 51	B
Twin Series according to DIN 3015, Part 3	52 - 63	C
Heavy Twin Series	64 - 69	D
STAUFF ACT Clamps: Anti-Corrosion Technology	70 - 89	E
STAUFF SWG: Stud Welding System	96 - 101	F
Notes	96 - 101	G
Custom-Designed Special Clamps	102 - 109	H
Light Series	110 - 119	I
Saddle / Piggyback Clamps	120 - 123	J
Flat Steel and Round Steel U-Bolt Clamps	124 - 133	K
Metal DIN Clamps	134 - 141	L
Construction Series	142 - 145	M
Other Types of Clamps	146 - 151	N
Technical Appendix	152 - 165	O
Appendix (Product-Specific Abbreviations / Global Contact Directory)	166 - 171	





Catalogue 1 STAUFF Clamps

- Block Clamps
- Special Clamps
- Light Series Clamps
- Saddle Clamps
- U-Bolt Clamps
- Metal Clamps
- Construction Series



Catalogue 2 STAUFF Connect

- Tube Connectors
- Assembly Tools and Devices

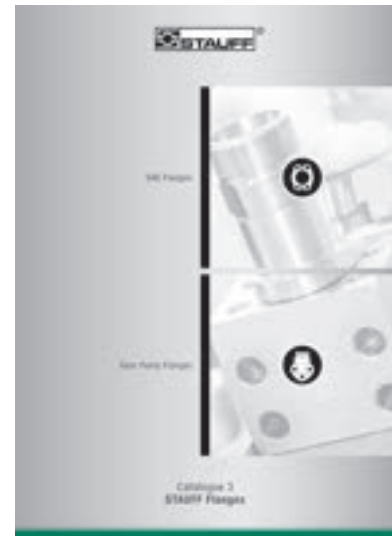

Catalogue 3 STAUFF Flanges

- SAE Flanges
- Gear Pump Flanges



Catalogue 4 STAUFF Hose Connectors

- Hose Connectors
- High-Pressure Hose Connectors



Catalogue 5 STAUFF Quick Release Couplings

- Push-to-Connect Couplings
- Multi Couplings
- Screw-to-Connect Couplings



Catalogue 6 STAUFF Valves

- Two-Way Ball Valves
- Multi-Way Ball Valves
- Flow Control and Check Valves
- Gauge Isolator Valves





**Catalogue 7
STAUFF Test**

- Test Couplings
- Test Adaptors
- Test Hoses and Connectors



**Catalogue 8
STAUFF Diagtronics**

- Pressure Gauges
- Hydraulic Testers
- Oil Analysis Equipment



**Catalogue 9
STAUFF Filtration Technology**

- Replacement Filter Elements
- Pressure Filters
- Return-Line Filters
- In-Line Filters
- Spin-On Filters
- Offline and Bypass Filters
- Filtration Systems

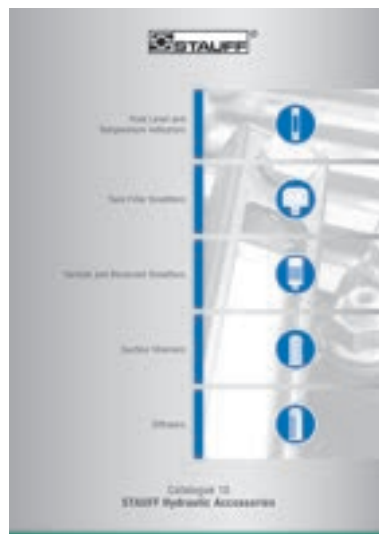

**Catalogue 10
STAUFF Hydraulic Accessories**

- Fluid Level and Temperature Indicators
- Tank Filler Breathers
- Giant and Desiccant Air Breathers
- Suction Strainers
- Diffusors

For more than 50 years, the companies of STAUFF Group have been developing, manufacturing and distributing pipework equipment and hydraulic components for mechanical and plant engineering and for service and industrial maintenance.

In addition to mobile and industrial hydraulic machinery, typical applications also include commercial and special purpose vehicles, rail transportation and energy technology. Likewise, STAUFF products are used in marine, oil and gas applications and in the process, food and chemical industries.

The overall range currently includes about 50000 standard products as well as numerous special and system solutions according to customer's specifications or based on our in-house development.

All STAUFF products undergo relevant testing in accordance with international regulations and are governed by the high standards of the in-house quality management system. Furthermore, many items have received certifications and approvals from various international institutes, organisations and authorities who have independently confirmed the quality and performance of the products.

Wholly-owned manufacturing, sales and service facilities in 18 countries and a tight global network of authorised distribution partners ensure high presence and service paired with a maximum of availability.



Quality Management – ISO 9001:2015
Environmental Management – ISO 14001:2015
Safety Management – ISO 45001:2018
Energy Management – ISO 50001:2018

STAUFF LINE Components

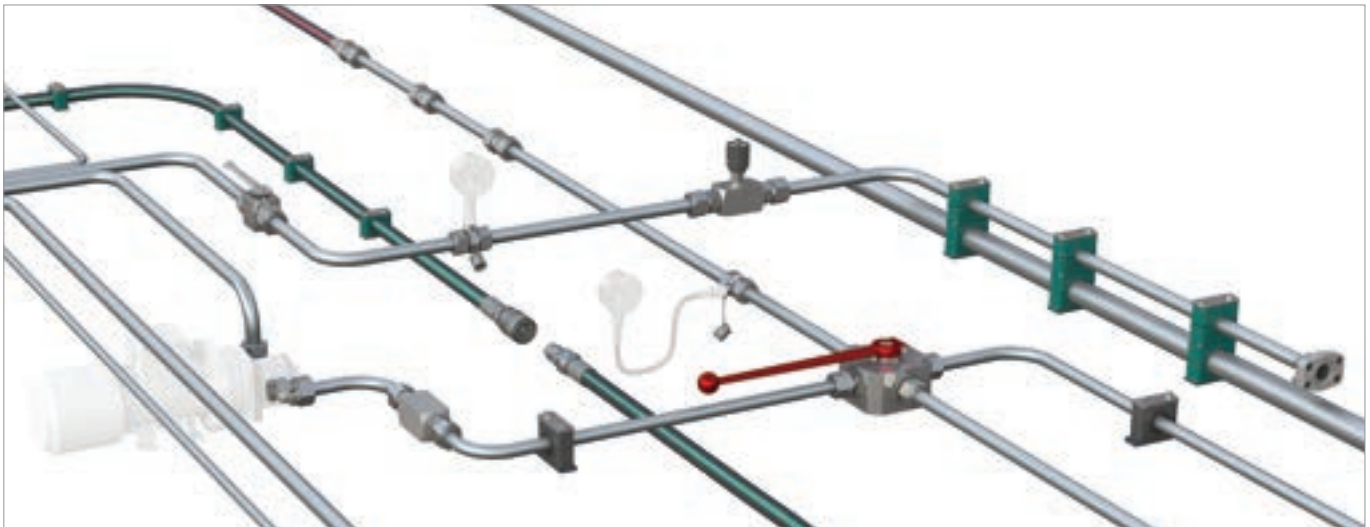

With the seven dedicated **STAUFF Line** product groups

- **STAUFF Clamps**
- **STAUFF Connect**
- **STAUFF Flanges**
- **STAUFF Hose Connectors**
- **STAUFF Quick Release Couplings**
- **STAUFF Valves**
- **STAUFF Test**

from own, in-house development and manufacturing, the companies of the STAUFF Group provide a comprehensive range of components for fastening and connecting pipes, tubes and hoses for mobile and industrial hydraulic applications and many other industries.

The portfolio is completed by components for shutting-off, regulating, throttling and measuring fluid media.

In order to perfectly match each other, STAUFF Line products are designed and offered on a high, uniform level of quality. A large proportion of the range made from steel comes as standard with the premium STAUFF Zinc/Nickel surface coating, which is also optionally available for many of the other components.

This coating offers the most reliable surface protection far beyond the previous market standards – even after transport, handling and assembly of the components – and meets all current legal requirements.

If desired, Original Equipment Manufacturers can be supported with value-added services, from **technical consultation to pre-assembly, assembly and kitting** as well as **logistics services**:

- Support with the **selection of suitable standard components** and ordering options; provision of **customised solutions** according to customer's specifications or based on our in-house development – from prototyping to large scale production
- **Analysis and optimization** of existing and design and developments of new systems aimed at increasing the efficiency and performance of machines and equipment and creating value for customers by reducing the total cost
- **Pre-assembly, assembly and kitting** of individual components to customer-specific system modules
- Individually coordinated **procurement solutions** (e.g. web shop and electronic data interchange) and **supply models** (e.g. from warehousing of customised components to Kanban logistics and just-in-time delivery of pre-fabricated system modules to the assembly lines of the customers) aimed at optimising material flows





Aligned with the needs of the market, the product groups

- **STAUFF Test**
- **STAUFF Diagtronics**
- **STAUFF Filtration Technology**
- **STAUFF Hydraulic Accessories**

include a comprehensive range of analogue and digital measuring equipment and devices, filtration systems and replacement filter elements as well as accessories for the construction of tanks, reservoirs, power packs and gear boxes in mobile and industrial hydraulics.

The offer is completed by relevant value-added services:

- Support with the **selection of suitable components** and ordering options; provision of **customised solutions** according to customer's specifications or based on our in-house development – from prototyping to large scale production
- Analysis of existing hydraulic circuits aimed at filtration systems, tank components and monitoring devices that perfectly match to the specific requirements, and developing integrated concepts to increase the efficiency and performance of machines and equipment
- Individually coordinated **procurement solutions** and **supply models**



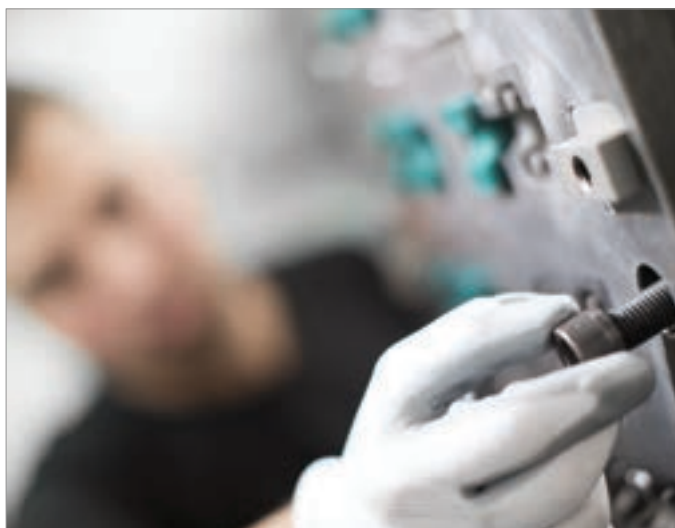
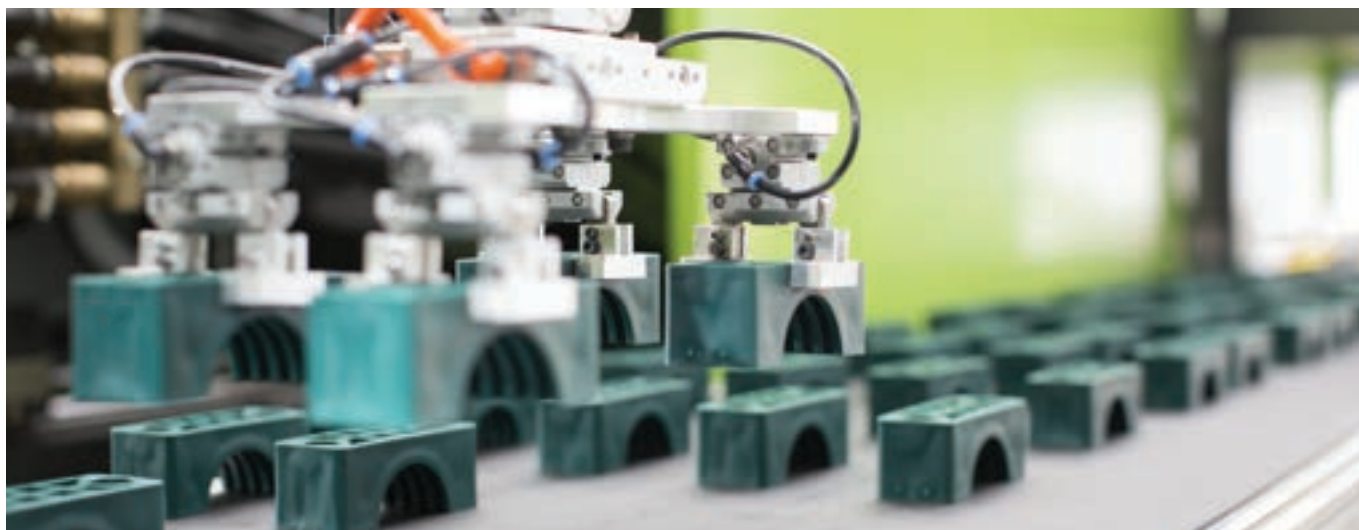

STAUFF Clamps

For more than 50 years, STAUFF Clamps symbolise quick and easy as well as secure installation of pipes, tubes, hoses, cables and other flexible and rigid components with outside diameters up to 1016 mm / 40.00 inch.

Their vibration and noise reducing features are appreciated as being an important contribution to environmental protection and occupational health and safety.

The processing of fire-proof clamp body materials, tested and approved according to several international fire-protection standards (such as BS 6853, EN 45545-2, UL 94) is only one of the many particular strengths of STAUFF.

STAUFF guarantees prompt service, even for customised solutions according to customer's specifications or based on our in-house development.

For selected types and series, independent certificates and approvals can be provided:

- American Bureau of Shipping
- Bureau Veritas
- Department of the Navy, New York
- Germanischer Lloyd
- Lloyd's Register of Shipping
- Registro Italiano Navale
- Technischer Überwachungsverein
- United States Coast Guard

For the finishing of the range of pipe, tube, hose and cable clamps as well as metal hardware in carbon steel, STAUFF relies on the STAUFF Zinc/Nickel surface coating which has proven successful for many years. It provides reliable surface protection – even after transport, handling and assembly – and meets all current legal requirements.

Versions in stainless steel V2A and V4A are generally available from stock. Alternative materials and surfaces are available on request.





STAUFF Zinc/Nickel Coating



Layers

- Sealing
- Passivation
- Zinc/Nickel
- Steel

With at least 1200 hours resistance against red rust, the STAUFF Zinc/Nickel surface coating offers excellent surface protection – even after transport, handling and assembly. This was confirmed by testing in the salt-spray chamber according to DIN EN ISO 9227.

Users across all industries and applications benefit from sophisticated technology, which has been developed for and used by the very demanding automotive industry for many years now and that is already the proven standard for a large proportion of STAUFF components since 2007.

- At least 1200 hours resistance to red rust / base metal corrosion under practical conditions in the salt-spray chamber according to DIN EN ISO 9227
- White rust occurs only by way of a slight grey haze
- Surpassing the requirements of the corrosion protection class K5 as defined by the VDMA, the German Engineering Association (360 hours resistance to white rust / 720 hours resistance to red rust)
- Free of hexavalent chrome Cr(VI)
- ELV compliant according to 2000/53/EC (End of Life Vehicles Directive)
- REACH compliant according to 1907/2006/EC (Registration, Evaluation, Authorisation and Restriction of Chemicals)
- RoHS compliant according to 2002/95/EC (Restrictions of the Use of Hazardous Substances)
- Appealing colour scheme with a bright semi-gloss surface finish – comparable to Stainless Steel
- Significantly reduced tendency to corrosion by contact with other metals (such as Aluminium and Stainless Steel)
- Improved abrasion resistance due to the ductility / plastic deformability of the coating
- Little to no risk of triggering allergies – nickel release is down to only a fraction of the statutory limits relating to objects which come into direct and prolonged contact with the skin (independent results of the reference test method according to DIN EN 1811 are available on request)
- Good paint adhesion properties
- Resistance against all commonly used hydraulic media





www.stauff.com/catalogues

The STAUFF online catalogue centre at www.stauff.com/catalogues provides fast and direct access to digital versions of this as well as other STAUFF product catalogues in all available languages.

Online Page-Flip Catalogues

- Easy navigation through index or the powerful full text search functionality
- Contents can be shared and forwarded by e-mail, printed or downloaded and saved in PDF file format
- Also suitable for mobile devices

Download Catalogues

- Download entire product catalogues and save them in PDF file format

Catalogue Request

- Contact form to request printed copies of the product catalogue as well as digital copies on USB stick

The fastest way to the online page-flip catalogue:

The links that can be found at the bottom edge of all pages of this product catalogue will lead you directly to the corresponding page in the online page-flip catalogue.

In doing so, contents can be searched, shared and forwarded by e-mail, printed or downloaded and saved in PDF file format.

Scan the QR code next to the direct link with the camera of your mobile device* and also use the functions in this way.

* may require a suitable app







www.stauff.com





With the STAUFF Digital Platform available at www.stauff.com, commercial customers and users of STAUFF products can not only inform themselves in all detail about the 50000 components typically available from stock, but also directly purchase these online without complex registration.

General information about the companies of STAUFF Group, latest business and product news as well as complete global contact details also be available.

Main Functionalities of the STAUFF Digital Platform:

-  **Around the clock**
Check stock availability and pricing for STAUFF products in real time
-  **Cross references**
Search by article designations of other manufacturers / suppliers
-  **Live chat**
Get directly in touch with the STAUFF customer service and sales team
-  **CAD database**
Download 3D models and 2D drawings for STAUFF products

Advantages as a Registered User of the STAUFF Digital Platform:

-  **Purchase STAUFF products**
Taking customer-specific pricing and delivery conditions into account
-  **Ordering w/o searching**
Quick ordering by entering article number, quantity and requested delivery date
-  **File upload**
Direct upload of orders with multiple positions in CSV or Excel file format
-  **Notepad function**
Create project lists to save interesting products for later

www.stauff.com/cad

Immediate access to and free download of 3D models and 2D drawings for a growing number of STAUFF products

www.filterinterchange.com

Online database for the quick and easy identification and interchange of almost all common brands and types of replacement filter elements

Follow STAUFF and keep yourself updated:

 **LinkedIn**
www.linkedin.com/company/stauff

 **Youtube**
www.youtube.com/stauffgroup

 **STAUFF Newsletters**
Automatic e-mail notifications about latest news from STAUFF
www.stauff.com/newsletter





Clamp Body
Profiled Inside Surface with Tension Clearance

14



Clamp Body
Smooth Inside Surface without Tension Clearance

15



Clamp Body with Elastomer Insert

16



Noise Reduction Clamp

17



Clamp Body for Conduit Hoses and Cable Inserts

18



Clamp Body
Compact Design for both Compact / Regular Hydraulic Hoses

19



Clamp Body
Rectangular Design for Proximity Switches

19

	Weld Plate SP	20		Cover Plate DP	26
	Elongated Weld Plate SPV	20		Hexagon Head Bolt for use with Cover Plate DP AS	26
	Twin Weld Plate DSP	21		Safety Washer (DIN 93) SI	27
	Group Weld Plate RAP	21		Safety Washer (DIN 463) SI	27
	Angled Weld Plate WSP	22		Socket Cap Screw IS	28
	Bridge Weld Plate BSP	22		Slotted Head Screw LI	28
	Clamp Body for Multi-Group Weld Plates	23		Hexagon Head Bolt for use with Insert ES / EP AS	28
	Multi-Group Weld Plate RAP-MGR	23		Insert ES / EP	28
	Hexagon Rail Nut SM	24		Safety Locking Plate SIG	29
	Mounting Rail TS	24		Stacking Bolt AF	29
	Channel Rail Adaptor CRA	25		Clamp Assemblies	30



Clamp Body - Profiled Design

Profiled Inside Surface with Tension Clearance

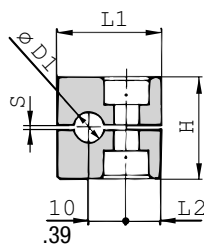
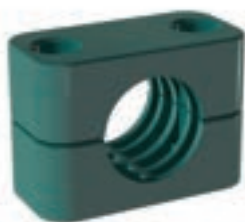

STAUFF Group 1

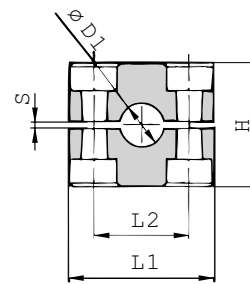

STAUFF Group 1A to 8

Ordering Codes

Clamp Body *1*06-*PP
Clamp Body, STAUFF Group 1A *1*06A-*PP

One clamp body is consisting of two clamp halves.

- * STAUFF Group **1**
- * Exact outside diameter Ø D1 (mm) **06**
- * Material code (see below) **PP**

Standard Materials

- Polypropylene**
Colour: Green
Material code: **PP**
- Polypropylene**
Colour: Black
Material code: **PP-BK**
- Polyamide**
Colour: Black
Material code: **PA**
- Thermoplastic Elastomer (87 Shore-A)**
Colour: Black
Material code: **SA**
- Aluminium**
Colour: Self-Colour
Material code: **AL** (STAUFF Group 1A to 6)

See pages 154 / 155 for material properties and technical information.

Special Materials

Please contact STAUFF for further details on fire-proof clamp body materials, tested and approved according to several international fire-protection standards (such as BS 6853, EN 45545-2, UL 94 and many more).

See pages 156 / 157 for material properties and technical information.

Product Features

- Proven, tested and trusted product in various markets
- Recommended for the safe installation of rigid pipes and tubes
- Available for all commonly used pipe and tube outside diameters
- Environmental protection due to vibration/noise reducing design
- Excellent weathering resistance, even under extreme conditions

Group	STAUFF	DIN	Outside Diameter		Nominal Bore		Ordering Codes (2 Clamp Halves)	Dimensions (mm/in)							
			Pipe / Tube Ø D1 (mm)	(in)	Pipe (in)	Copper Tube ASTM B88 (in)		(** = Material)	L1	L2	H	S min.	Width		
1		0	6				106-**								
			6,4	1/4			106.4-**								
			8	5/16			108-**	28	9,5	27	0,4	30			
			9,5	3/8		1/4	109.5-**	1.10	.37	1.06	.02	1.18			
			10		1/8		110-**								
1A		1	6				106A-**								
			6,4	1/4			106.4A-**								
			8	5/16			108A-**	37	20	27	0,4	30			
			9,5	3/8		1/4	109.5A-**	1.46	.79	1.06	.02	1.18			
			10		1/8		110A-**								
2		2	12				112-**								
			12,7	1/2		3/8	212.7-**								
			13,5		1/4		213.5-**								
			14				214-**								
			15				215-**	42	26	33	0,6	30			
3		3	16	5/8		1/2	216-**	1.65	1.02	1.30	.02	1.18			
			17,2		3/8		217.2-**								
			18				218-**								
			19	3/4			319-**								
			20				320-**								
4		4	21,3		1/2		321.3-**	50	33	36	0,6	30			
			22	7/8		3/4	322-**	1.97	1.30	1.42	.02	1.18			
			25				325-**								
			25,4	1			325.4-**								
			26,9		3/4		426.9-**								
5		5	28				428-**								
			28,6			1	428.6-**	59	40	42	0,6	30			
			30				430-**	2.32	1.57	1.65	.02	1.18			
			32				432-**								
			32	1-1/4			532-**								
6		6	33,7		1		533.7-**								
			35			1-1/4	535-**								
			38	1-1/2			538-**	71	52	58	0,8	30			
			40				540-**	2.80	2.05	2.28	.03	1.18			
			41,3		1-1/2		541.3-**								
7		7	42		1-1/4		542-**								
			44,5	1-3/4			644.5-**								
			48,3		1-1/2		648.3-**	86	66	66	0,8	30			
			50,8	2			650.8-**	3.39	2.60	2.60	.03	1.18			
			54		2		654-**								
8		8	57,2	2-1/4			757.2-**								
			60,3		2		760.3-**								
			63,5	2-1/2			763.5-**	121	94	93	0,8	30			
			70	2-3/4			770-**	4.76	3.70	3.66	.03	1.18			
			73		2-1/2 (ANSI B 36-10)		773-**								
8		8	76,1	3	2-1/2 (DIN EN 10220)		776.1-**								
			88,9		3		888.9-**	147	120	118	0,8	30			
			102	4	3-1/2		8102L-**	5.79	4.72	4.65	.03	1.18			

Additional outside diameters are available upon request. Please contact STAUFF for further information.

Dimensional drawings: All dimensions in mm (in).



Clamp Body - Type H

Smooth Inside Surface without Tension Clearance

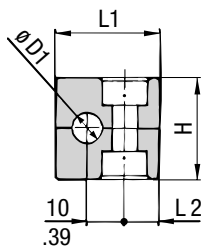

STAUFF Group 1

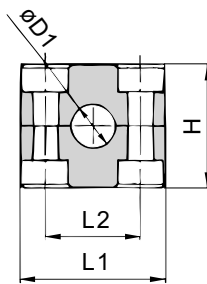

STAUFF Group 1A to 8

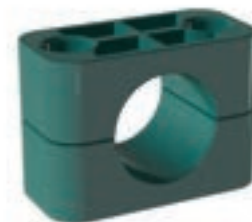

A

Group	STAUFF	DIN	Outside Diameter		Ordering Codes (2 Clamp Halves)	Dimensions (mm/in)			
			Hose Ø D1 (mm)	(in)		(** - H = Material)	L1	L2	H
1	0	6			106-**-H	28	9,5	26	30
		6,4	1/4	106.4-**-H					
		8	5/16	108-**-H					
		9,5	3/8	109.5-**-H					
		10		110-**-H					
		12		112-**-H					
1A	1	6			106A-**-H	37	20	26	30
		6,4	1/4	106.4A-**-H					
		8	5/16	108A-**-H					
		9,5	3/8	109.5A-**-H					
		10		110A-**-H					
		12		112A-**-H					
2	2	12,7	1/2		212.7-**-H	42	26	32	30
		13,5		213.5-**-H					
		14		214-**-H					
		15		215-**-H					
		16	5/8	216-**-H					
		17,2		217.2-**-H					
		18		218-**-H					
3	3	19	3/4		319-**-H	50	33	35,5	30
		20		320-**-H					
		21,3		321.3-**-H					
		22	7/8	322-**-H					
		25		325-**-H					
		25,4	1	325.4-**-H					
4	4	26,9			426.9-**-H	59	40	41,5	30
		28		428-**-H					
		30		430-**-H					
		32		432-**-H					
		32	1-1/4	532-**-H					
5	5	33,7			533.7-**-H	71	52	56,5	30
		35		535-**-H					
		38	1-1/2	538-**-H					
		40		540-**-H					
		42		542-**-H					
		44,5	1-3/4	644.5-**-H					
6	6	48,3			648.3-**-H	86	66	64,5	30
		50,8	2	650.8-**-H					
		54		654-**-H					
		57,2	2-1/4	757.2-**-H					
		60,3		760.3-**-H					
7	7	63,5	2-1/2		763.5-**-H	121	94	92	30
		70	2-3/4	770-**-H					
		73		773-**-H					
		76,1	3	776.1-**-H					
		88,9		888.9-**-H					
		102	4	8102L-**-H					

Ordering Codes

Clamp Body ***1*06-*PP-H**
 Clamp Body, STAUFF Group 1A ***1*06A-*PP-H**

One clamp body is consisting of two clamp halves.

* STAUFF Group **1**
 * Exact outside diameter Ø D1 (mm) **06**
 * Material code (see below) **PP-H**

Standard Materials

Polypropylene

 Colour: Green
 Material code: **PP-H**

Polypropylene

 Colour: Black
 Material code: **PP-H-BK**

Polyamide

 Colour: Black
 Material code: **PA-H**

Thermoplastic Elastomer (87 Shore-A)

 Colour: Black
 Material code: **SA-H**

See pages 154 / 155 for material properties and technical information.

Special Materials

Please contact STAUFF for further details on fire-proof clamp body materials, tested and approved according to several international fire-protection standards (such as BS 6853, EN 45545-2, UL 94 and many more).

See pages 156 / 157 for material properties and technical information.

Product Features

- Proven, tested and trusted product in various markets
- Recommended for the safe installation of hoses and cables
- Chamfered edges avoid damaging of the hoses and cables
- Available for all commonly used hose and cable outside diameters
- Excellent weathering resistance, even under extreme conditions

Additional outside diameters are available upon request. Please contact STAUFF for further information.



Clamp Body with Elastomer Insert Type RI

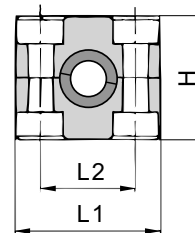
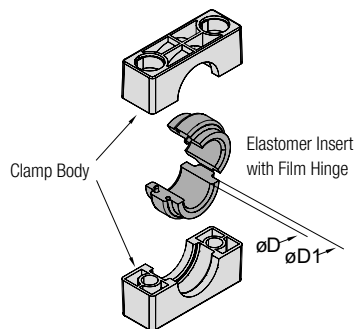

A

Ordering Codes

Clamp Assembly ***4*06-*PP-R**

One assembly is consisting of one clamp body and one insert.

- * STAUFF Group **4**
- * Exact outside diameter Ø D (mm) **06**
- * Material code (see below) **PP-R**

Clamp Body ***4-*PP-R**

One clamp body is consisting of two clamp halves.

- * STAUFF Group **4**
- * Material code (see below) **PP-R**

Elastomer Insert ***RI-*06-*4/4S**

- * Elastomer Insert **RI**
- * Exact outside diameter Ø D (mm) **06**
- * STAUFF Group 4 (Standard) and 4S (Heavy) **4/4S**
- 6 (Standard) and 5S (Heavy) **6/5S**

Standard Materials



Polypropylene
Colour: Black
Material code: **PP-R**



Polyamide
Colour: Black
Material code: **PA-R**



Elastomer Insert
Thermoplastic Elastomer (73 Shore-A)
Colour: Black

See pages 154 / 155 for material properties and technical information.

Special Materials

Please contact STAUFF for further details on fire-proof clamp body materials, tested and approved according to several international fire-protection standards (such as BS 6853, EN 45545-2, UL 94 and many more).

See pages 156 / 157 for material properties and technical information.

Product Features

- Proven, tested and trusted product in various markets
- Either for the extra vibration/noise reducing installation of pipes and tubes or the extra gentle installation of hoses and cables
- Available for all commonly used outside diameters
- Excellent weathering resistance, even under extreme conditions

Group	STAUFF	DIN	Outside Diameter		Ordering Codes	(**R = Clamp Body Material)		Dimensions														
			Pipe / Tube / Hose	Ø D		Clamp Assembly	Clamp Body	Insert *	(mm / in)	Ø D1	L1	L2	H	Width								
4	4	4	6		406-**-R	4-**-R	RI-06-4/4S	25	59	40	41,2	30										
			8	5/16	408-**-R		RI-08-4/4S															
			10		410-**-R		RI-10-4/4S															
			12		412-**-R		RI-12-4/4S															
			12,7	1/2	412.7-**-R		RI-12.7-4/4S															
			14		414-**-R		RI-14-4/4S						.98	2.32	1.57	1.62	1.18					
			15		415-**-R		RI-15-4/4S															
			16	5/8	416-**-R		RI-16-4/4S															
			17,2		417.2-**-R		RI-17.2-4/4S															
			18		418-**-R		RI-18-4/4S															
			19	3/4	419-**-R		RI-19-4/4S															
			6	6	6		20												620-**-R	6-**-R	RI-20-6/5S	38
21,3		621.3-**-R				RI-21.3-6/5S																
22	7/8	622-**-R				RI-22-6/5S																
25		625-**-R				RI-25-6/5S																
26,9		626.9-**-R				RI-26.9-6/5S	1.50	3.39	2.60	2.54	1.18											
28		628-**-R				RI-28-6/5S																
30		630-**-R				RI-30-6/5S																
32	1-1/4	632-**-R				RI-32-6/5S																

* Elastomer Inserts for Standard Series clamp bodies, STAUFF Group 4 also fit into Heavy Series clamp bodies, STAUFF Group 4S. Elastomer Inserts for Standard Series clamp bodies, STAUFF Group 6 also fit into Heavy Series clamp bodies, STAUFF Group 5S.

Additional outside diameters are available upon request. Please contact STAUFF for further information.



Noise Reduction Clamp
Type NRC

A

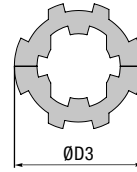
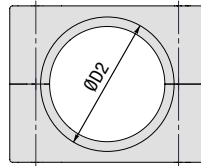
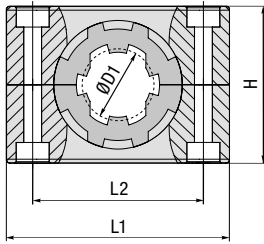

Group	STAUFF	DIN	Outside Diameter		Ordering Codes	Clamp Body	NRC Insert	Dimensions							
			Pipe / Tube	Ø D1				(mm)	(in)	(mm/in)	ØD2	ØD3	L1	L2	H
2	2	2	6		206-PP-NRC	2-PP-NRC	RI-NRC-6-2								
			8	5/16	208-PP-NRC		RI-NRC-8-2								
			10		210-PP-NRC		RI-NRC-10-2	25	26	42	26	32	30		
			12		212-PP-NRC		RI-NRC-12-2	.98	1.02	1.65	1.02	1.26	1.18		
			12,7	1/2	212.7-PP-NRC		RI-NRC-12.7-2								
3	3	3	14		314-PP-NRC	3-PP-NRC	RI-NRC-14-3								
			15		315-PP-NRC		RI-NRC-15-3	28	29	50	33	35,5	30		
			16	5/8	316-PP-NRC		RI-NRC-16-3	1.10	1.14	1.97	1.30	1.40	1.18		
4	4	4	18		418-PP-NRC	4-PP-NRC	RI-NRC-18-4								
			20		420-PP-NRC		RI-NRC-20-4	34	35	59	40	41,5	30		
5	5	5	21,3		521.3-PP-NRC	5-PP-NRC	RI-NRC-21.3-5								
			22	7/8	522-PP-NRC		RI-NRC-22-5								
			25		525-PP-NRC		RI-NRC-25-5								
			26,9		526.9-PP-NRC		RI-NRC-26.9-5	49	50	71	52	56,5	30		
			28		528-PP-NRC		RI-NRC-28-5	1.93	1.97	2.80	2.05	2.22	1.18		
			30		530-PP-NRC		RI-NRC-30-5								
6	6	6	32	1-1/4	532-PP-NRC	RI-NRC-32-5									
			33,7		633.7-PP-NRC	RI-NRC-33.7-6									
			35		635-PP-NRC	RI-NRC-35-6									
			38	1-1/2	638-PP-NRC	RI-NRC-38-6	60	61	86	66	64,5	30			
			40		640-PP-NRC	RI-NRC-40-6	2.36	2.40	3.39	2.60	2.54	1.18			
			42		642-PP-NRC	RI-NRC-42-6									

Ordering Codes

 Clamp Assembly ***2*12-*PP-NRC**

One assembly is consisting of one clamp body and one insert.

- * STAUFF Group **2**
- * Exact outside diameter Ø D1 (mm) **12**
- * Material code (see below) **PP-NRC**

 NRC Clamp Body ***2-*PP-NRC**

One NRC clamp body is consisting of two clamp halves.

- * STAUFF Group **2**
- * Material code (see below) **PP-NRC**

 NRC Elastomer Insert ***RI-NRC-*12-*2**

One NRC elastomer insert is consisting of two insert halves.

- * NRC Elastomer Insert **RI-NRC**
- * Exact outside diameter ØD1 (mm) **12**
- * STAUFF Group **2**

Standard Materials



Polypropylene
Colour: Black
Material code: **PP-NRC**



Elastomer Insert
Thermoplastic Elastomer (73 Shore-A)
Colour: Black

See pages 154 / 155 for material properties and technical information.

Alternative materials are available upon request. Please contact STAUFF for further information.

Special Materials

Please contact STAUFF for further details on fire-proof clamp body materials, tested and approved according to several international fire-protection standards (such as BS 6853, EN 45545-2, UL 94 and many more).

See pages 156 / 157 for material properties and technical information.

Additional outside diameters are available upon request. Please contact STAUFF for further information.

Product Features

- Designed for the noise and vibration reducing installation of pipes and tubes
- Suitable for the most common outside diameters from 6 to 42 mm and from ¼ to 1 ½ inch respectively
- Working principle based on a specially shaped, two-part elastomer insert, which mechanically absorbs vibration in the pipe or tube and as a result reduces noises arising to a minimum
- Elastomer insert is in particular distinguished by how little of its surface is in contact with the pipe or tube as well as with the clamp body
- Light tension of the elastomer insert in mounted condition provides the necessary clamping force
- Tongue-groove contour of the elastomer insert and the clamp body (which is reversed and thus diverges from standard DIN 3015 clamps with elastomer insert) enables the system to be used for the maximum range of outside diameters per clamp size, which contributes to flexibility, versatility and optimisation of the required installation space



Clamp Body for Conduit Hoses and Cable Inserts

Type CHC

A

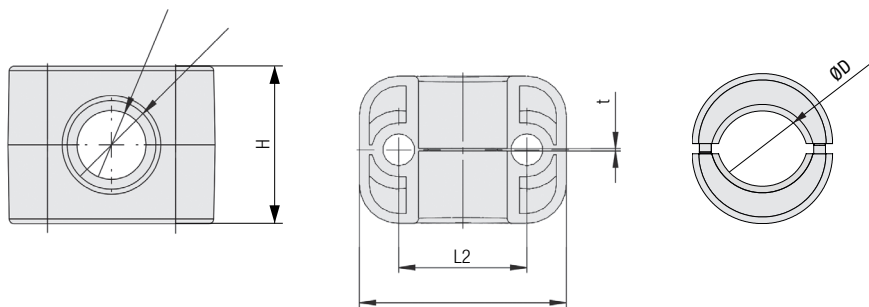

Ordering Codes

Clamp Assembly

***3*17-*10/14-*PA-CHC*SA-VO**

One assembly is consisting of one clamp body and one insert. (consisting of two halves).

- * STAUFF Group **3**
- * Nominal Size of the Conduit Hose **17**
- * Diameter Range Cable ØD (mm) **10/14**
- * Material code clamp body (see below) **PA-CHC**
- * Material code insert (see below) **SA-VO**

CHC Clamp Body

***3*17-*PA-CHC**

One CHC Clamp Body is consisting of two clamp halves.

- * STAUFF Group **3**
- * Nominal Size of the Conduit Hose **17**
- * Material code clamp body (see below) **PA-CHC**

CHC Elastomer Insert

***RI-CHC-*10/14*3*SA-VO**

One CHC Elastomer Insert is consisting of two insert halves.

- * CHC Elastomer insert **RI-CHC**
- * Diameter Range Cable ØD (mm) **10/14**
- * STAUFF Group **3**
- * Material code insert (see below) **SA-VO**

Group	STAUFF DIN	Nominal Size Conduit Hose	ØD (mm/in) Cable	Ordering Codes (* = Material)			Dimensions (mm/in)						
				Clamp Assembly (Clamp Body + Insert)	Clamp Body (2 Halves)	CHC-Insert (2 Halves)	ØD1	ØD2	t	L1	L2	H	Width
2	2	10	6 ... 8 .2431		210-*		13	11	0,5	42	26	32	30
		12	8 ... 10 .3139		212-*		16	13,5	0,5	42	26	32	30
3	3	17	7 ... 10 .2839	317-7/10-*-*	317-*	RI-CHC-7/10-3-*	21,5	18	0,7	50	33	35,5	30
			10 ... 14 .3955	317-10/14-*-*	317-*	RI-CHC-10/14-3-*	.85	.71	.03	1.97	1.30	1.40	1.18
			14 ... 18 .5571	423-14/18-*-*	423-*	RI-CHC-14/18-4-*	29	24,5	0,7	59	40	41,5	30
4	4	23	18 ... 20 .7179		423-*		1.14	.96	.03	2.32	1.57	1.63	1.18
			20 ... 26,9 .79 ... 1.06		529-*		35	30,5	1,0	71	52	56,5	30
5	5	36	26,9 ... 33,7 1.06 ... 1.33		536-*		1.38	1.20	.04	2.80	2.05	2.22	1.18
			33,7 ... 42 1.33 ... 1.65		648-*		43	38,5	1,0	71	52	56,5	30
6	6	48					1.69	1.52	.04	2.80	2.05	2.22	1.18
							55	49,5	1,0	86	66	64,5	30
							2.17	1.95	.51	3.39	2.60	2.54	1.18

Additional outside diameters are available upon request. Please contact STAUFF for further information.

Product Features

- Design of the inside surface of the clamp body prevents corrugated conduit hoses from sliding
- Elastomer Insert for the safe and damage-free installation of single cables as an option
- Chamfered edges avoid damaging of the conduit hoses
- Available for all commonly used nominal sizes
- Excellent weathering resistance, even under extreme conditions

Materials



Polyamide
Colour: Black
Material code: **PA-CHC**



fire-proof clamp body material made of Polyamide
Colour: Black
Material code: **PA-VO-CHC-BK**



Elastomer Insert Thermoplastic Elastomer (73 Shore-A)
Colour: Black
Material code: **SA**



Elastomer Insert fire-proof clamp body material made of Thermoplastic Elastomer (86 Shore-A)
Colour: White
Material code: **SA-VO**

See pages 154 - 157 for material properties and technical information.

Alternative materials are available upon request. Please contact STAUFF for further information.

Recommended Bolt Lengths (Socket Cap Screw IS)

for use without Cover Plate DP, assembly with Weld Plate SP, Hexagon Rail Nut SM and Channel Rail Adaptor CRA.

Group	STAUFF DIN	Metric ISO thread	Unified coarse (UNC) thread
2	2	M6 x 25	1/4-20 UNC x 1
3	3	M6 x 30	1/4-20 UNC x 1-1/8
4	4	M6 x 35	1/4-20 UNC x 1-3/8
5	5	M6 x 50	1/4-20 UNC x 2
6	6	M6 x 60	1/4-20 UNC x 2-1/2

See page 30 for further information on ordering.



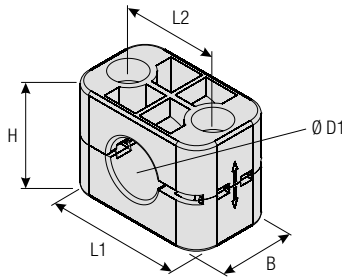

For Use with Regular Hose

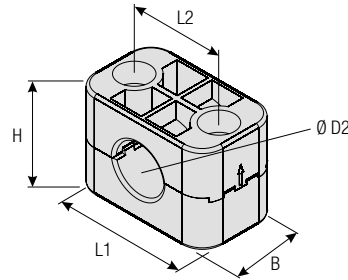

For Use with Compact Hose
(Upper Clamp Half rotated by 180°)

Group	STAUFF	DIN	Outside Diameter Regular Hose		Outside Diameter Compact Hose		Ordering Codes (2 Clamp Halves) (*-*-* = Material)	Dimensions (mm/in)				
			Ø D1 (mm)	(in)	Ø D2 (mm)	(in)		L1	L2	H		B
3	3	19	.75	17,4	.69	319-***-CC-BK						
		22,2	.87	20,6	.81	322.2-***-CC-BK	50 1.97	33 1.30	35,5 1.40	34 1.34	30 1.18	
		25,4	1.00	23,7	.93	325.4-***-CC-BK						

Additional outside diameters are available upon request. Please contact STAUFF for further information.

Product Features

- Only one clamp body required for two different hose diameters (compact hose + regular hose)
- Rotate upper clamp half by 180° and use clamp body to fasten compact hoses instead of regular hoses
- Available for three different combinations of outside hose diameters
- Outer dimensions according to DIN 3015, Part 1
- Effective cost reduction due to lower inventories

Special Materials

Please contact STAUFF for further details on fire-proof clamp body materials, tested and approved according to several international fire-protection standards (such as BS 6853, EN 45545-2, UL 94 and many more).

See pages 156 / 157 for material properties and technical information.

Ordering Codes

Clamp Body ***3*19-*PP-H-CC-BK**

One clamp body is consisting of two clamp halves.

- * STAUFF Group **3**
- * Outside diameter Ø D1 (mm) of regular hose **19**
- * Material code (see below) **PP-H-CC-BK**

Standard Materials

Polypropylene
Colour: Black
Material code: **PP-H-CC-BK**

See pages 154 / 155 for material properties and technical information.

Ordering Codes

One clamp body is consisting of two clamp halves.

Clamp Body **540-40-PP-VK**
Rectangular design with a square of 40 mm x 40 mm / 1.57 in x 1.57 in

Clamp Body **540-36-PP-VK**
Rectangular design with a square of 40 mm x 36 mm / 1.57 in x 1.42 in

Please replace PP by PA to order a clamp body made of Polyamide instead of Polypropylene.

Product Features

- Outer dimensions of clamp body according to Standard Series, STAUFF Group 5
- For proximity switches according to DIN EN 60947-5-2 or similar, rectangular construction, with a square of 40 mm x 40 mm / 1.57 in x 1.57 in or 40 mm x 36 mm / 1.57 in x 1.42 in
- For proximity switches according to DIN EN 60947-5-2 or similar, round construction, please use Standard Series clamp body, STAUFF Group 4, with the diameter required (e.g. 430-PP)
- Use with Hexagon Rail Nut SM and Mounting Rail TS to provide axial and horizontal position adjustment by loosening the bolts

Clamp Body - Rectangular Design Type VK



Single Weld Plate Type SP

A

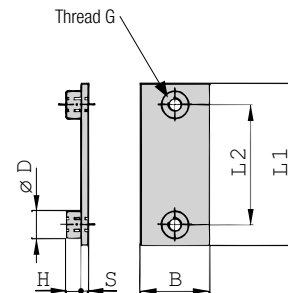
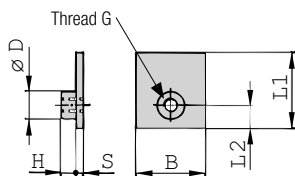

STAUFF Group 1

STAUFF Group 1A to 8

Ordering Codes

Weld Plate

***SP-*1-*M-*W2**

- * Single Weld Plate **SP**
- * STAUFF Group **1**
- * Thread code Metric ISO thread **M**
 Unified coarse (UNC) thread **U**
- * Material code Carbon Steel, phosphated **W2**
 Carbon Steel, zinc/nickel-plated **W3**

 Stainless Steel V2A **W4**
 1.4301 / 1.4305 (AISI 304 / 303)
 Stainless Steel V4A **W5**
 1.4401 / 1.4571 (AISI 316 / 316 Ti)

 Aluminium EN AW-6060 **W85**
 (Dimension S: 5 mm / .20 in)

Group	DIN	Dimensions (mm/in)	Thread G	L1	L2	B	S	H	ØD	Ordering Codes (Standard Options)
1	0	M6	31,5	10	30	3	6,5	12		SP-1-M-W2
		1/4-20 UNC	1.24	0.39	1.18	.12	.26	.47		SP-1-U-W2
1A	1	M6	36	20	30	3	6,5	12		SP-1A-M-W2
		1/4-20 UNC	1.42	0.79	1.18	.12	.26	.47		SP-1A-U-W2
2	2	M6	42	26	30	3	6,5	12		SP-2-M-W2
		1/4-20 UNC	1.65	1.02	1.18	.12	.26	.47		SP-2-U-W2
3	3	M6	50	33	30	3	6,5	12		SP-3-M-W2
		1/4-20 UNC	1.97	1.30	1.18	.12	.26	.47		SP-3-U-W2
4	4	M6	60	40	30	3	6,5	12		SP-4-M-W2
		1/4-20 UNC	2.36	1.57	1.18	.12	.26	.47		SP-4-U-W2
5	5	M6	71	52	30	3	6,5	12		SP-5-M-W2
		1/4-20 UNC	2.80	2.05	1.18	.12	.26	.47		SP-5-U-W2
6	6	M6	88	66	30	3	6,5	12		SP-6-M-W2
		1/4-20 UNC	3.46	2.60	1.18	.12	.26	.47		SP-6-U-W2
7	7	M6	122	94	30	5	6,5	12		SP-7-M-W2
		1/4-20 UNC	4.80	3.70	1.18	.20	.26	.47		SP-7-U-W2
8	8	M6	148	120	30	5	6,5	12		SP-8-M-W2
		1/4-20 UNC	5.83	4.72	1.18	.20	.26	.47		SP-8-U-W2

All threaded parts are available with Metric ISO thread or unified coarse (UNC) thread according to dimension table. Alternative materials and surface finishings are available upon request. Contact STAUFF for further information.

Elongated Weld Plate Type SPV

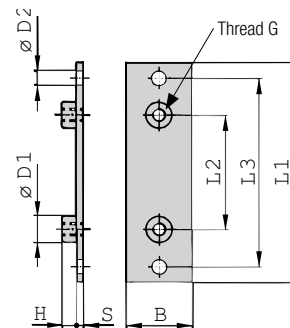
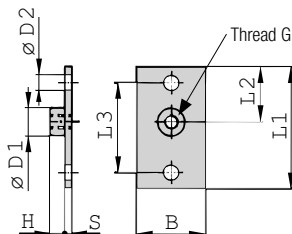

STAUFF Group 1

STAUFF Group 1A to 8

Ordering Codes

Weld Plate

***SPV-*1-*M-*W2**

- * Elongated Weld Plate **SPV**
- * STAUFF Group **1**
- * Thread code Metric ISO thread **M**
 Unified coarse (UNC) thread **U**
- * Material code Carbon Steel, phosphated **W2**
 Carbon Steel, zinc/nickel-plated **W3**

 Stainless Steel V2A **W4**
 1.4301 / 1.4305 (AISI 304 / 303)
 Stainless Steel V4A **W5**
 1.4401 / 1.4571 (AISI 316 / 316 Ti)

Group	DIN	Dimensions (mm/in)	Thread G	L1	L2	L3	B	S	H	ØD1	ØD2	Ordering Codes (Standard Options)
1	0	M6	58	24,5	44	30	3	6,5	12	6,5		SPV-1-M-W2
		1/4-20 UNC	2.28	.96	1.73	1.18	.12	.26	.47	.26		SPV-1-U-W2
1A	1	M6	64	20	50	30	3	6,5	12	6,5		SPV-1A-M-W2
		1/4-20 UNC	2.52	.79	1.97	1.18	.12	.26	.47	.26		SPV-1A-U-W2
2	2	M6	70	26	56	30	3	6,5	12	6,5		SPV-2-M-W2
		1/4-20 UNC	2.76	1.02	2.20	1.18	.12	.26	.47	.26		SPV-2-U-W2
3	3	M6	78	33	64	30	3	6,5	12	6,5		SPV-3-M-W2
		1/4-20 UNC	3.07	1.30	2.52	1.18	.12	.26	.47	.26		SPV-3-U-W2
4	4	M6	87	40	73	30	3	6,5	12	6,5		SPV-4-M-W2
		1/4-20 UNC	3.43	1.57	2.87	1.18	.12	.26	.47	.26		SPV-4-U-W2
5	5	M6	100	52	86	30	3	6,5	12	6,5		SPV-5-M-W2
		1/4-20 UNC	3.94	2.05	3.39	1.18	.12	.26	.47	.26		SPV-5-U-W2
6	6	M6	115	66	100	30	3	6,5	12	6,5		SPV-6-M-W2
		1/4-20 UNC	4.53	2.60	3.94	1.18	.12	.26	.47	.26		SPV-6-U-W2
7	7	M6	150	94	136	30	5	6,5	12	6,5		SPV-7-M-W2
		1/4-20 UNC	5.91	3.70	5.35	1.18	.20	.26	.47	.26		SPV-7-U-W2
8	8	M6	178	120	162	30	5	6,5	12	6,5		SPV-8-M-W2
		1/4-20 UNC	7.01	4.72	6.38	1.18	.20	.26	.47	.26		SPV-8-U-W2

All threaded parts are available with Metric ISO thread or unified coarse (UNC) thread according to dimension table. Alternative materials and surface finishings are available upon request. Contact STAUFF for further information.



**Twin Weld Plate
for 2 Clamp Bodies
Type DSP**

A

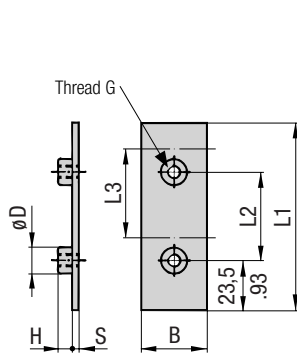

STAUFF Group 1

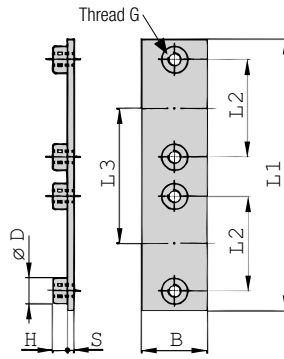

STAUFF Group 1A to 8



Group STAUFF	DIN	Dimensions (mm/in)								Ordering Codes (Standard Options)
		Thread G	L1	L2	L3	B	S	H	ØD	
1	0	M6	87	40	40	30	3	6.5	12	DSP-1-40-M-W2
		1/4-20 UNC	3.43	1.57	1.57	1.18	.12	.26	.47	DSP-1-40-U-W2
1A	1	M6	77	20	37	30	3	6.5	12	DSP-1A-37-M-W2
		1/4-20 UNC	3.03	.79	1.46	1.18	.12	.26	.47	DSP-1A-37-U-W2
2	2	M6	86	26	44	30	3	6.5	12	DSP-2-44-M-W2
		1/4-20 UNC	3.39	1.02	1.73	1.18	.12	.26	.47	DSP-2-44-U-W2
3	3	M6	102	33	52	30	3	6.5	12	DSP-3-52-M-W2
		1/4-20 UNC	4.02	1.30	2.05	1.18	.12	.26	.47	DSP-3-52-U-W2
4	4	M6	120	40	60	30	3	6.5	12	DSP-4-60-M-W2
		1/4-20 UNC	4.72	1.57	2.36	1.18	.12	.26	.47	DSP-4-60-U-W2
5	5	M6	145	52	75	30	3	6.5	12	DSP-5-75-M-W2
		1/4-20 UNC	5.71	2.05	2.95	1.18	.12	.26	.47	DSP-5-75-U-W2
6	6	M6	178	66	90	30	3	6.5	12	DSP-6-90-M-W2
		1/4-20 UNC	7.01	2.60	3.54	1.18	.12	.26	.47	DSP-6-90-U-W2

All threaded parts are available with Metric ISO thread or unified coarse (UNC) thread according to dimension table. Alternative materials and surface finishings are available upon request. Contact STAUFF for further information.

Ordering Codes

Weld Plate *DSP-*1-*40-*M-*W2

- * Twin Weld Plate for 2 Clamp Bodies **DSP**
- * STAUFF Group **1**
- * Pipe center spacing L3 (mm) **40**
- * Thread code Metric ISO thread **M**
Unified coarse (UNC) thread **U**
- * Material code Carbon Steel, phosphated **W2**
Carbon Steel, zinc/nickel-plated **W3**
Stainless Steel V2A **W4**
1.4301 / 1.4305 (AISI 304 / 303) **W4**
Stainless Steel V4A **W5**
1.4401 / 1.4571 (AISI 316 / 316 Ti) **W5**

**Group Weld Plate
for 5 or 10 Clamp Bodies
Type RAP**

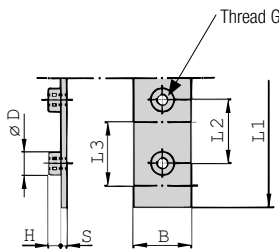

STAUFF Group 1

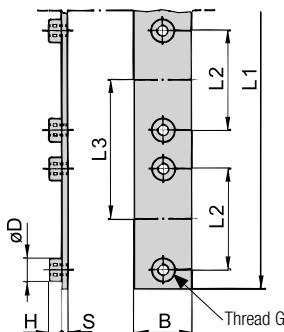

STAUFF Group 1A to 8



Group STAUFF	DIN	Dimensions (mm/in)								Ordering Codes (Standard Options)
		Thread G	L1	L2	L3	B	S	H	ØD	
1	0	M6	314	31	31	30	4	6.5	12	RAP-1-31-10-M-W1
		1/4-20 UNC	12.36	1.22	1.22	1.18	.16	.26	.47	RAP-1-31-10-U-W1
1A	1	M6	373	20	37	30	4	6.5	12	RAP-1A-37-10-M-W1
		1/4-20 UNC	14.69	.79	1.46	1.18	.16	.26	.47	RAP-1A-37-10-U-W1
2	2	M6	442	26	44	30	4	6.5	12	RAP-2-44-10-M-W1
		1/4-20 UNC	17.40	1.02	1.73	1.18	.16	.26	.47	RAP-2-44-10-U-W1
3	3	M6	521	33	52	30	4	6.5	12	RAP-3-52-10-M-W1
		1/4-20 UNC	20.51	1.30	2.05	1.18	.16	.26	.47	RAP-3-52-10-U-W1
4	4	M6	300	40	60	30	4	6.5	12	RAP-4-60-5-M-W1
		1/4-20 UNC	11.81	1.57	2.36	1.18	.16	.26	.47	RAP-4-60-5-U-W1
5	5	M6	378	52	75	30	4	6.5	12	RAP-5-75-5-M-W1
		1/4-20 UNC	14.88	2.05	2.95	1.18	.16	.26	.47	RAP-5-75-5-U-W1
6	6	M6	450	66	90	30	4	6.5	12	RAP-6-90-5-M-W1
		1/4-20 UNC	17.72	2.60	3.54	1.18	.16	.26	.47	RAP-6-90-5-U-W1

All threaded parts are available with Metric ISO thread or unified coarse (UNC) thread according to dimension table. Alternative materials and surface finishings are available upon request. Contact STAUFF for further information.

Ordering Codes

Weld Plate *RAP-*1-*31-*10-*M-*W1

- * Group Weld Plate for 5 or 10 Clamp Bodies **RAP**
- * STAUFF Group **1**
- * Pipe center spacing L3 (mm) **31**
- * Number of clamps **10**
- * Thread code Metric ISO thread **M**
Unified coarse (UNC) thread **U**
- * Material code Carbon Steel, phosphated **W2**
Carbon Steel, zinc/nickel-plated **W3**
Stainless Steel V2A **W4**
1.4301 / 1.4305 (AISI 304 / 303) **W4**
Stainless Steel V4A **W5**
1.4401 / 1.4571 (AISI 316 / 316 Ti) **W5**

Dimensional drawings: All dimensions in mm (in).



Angled Weld Plate Type WSP

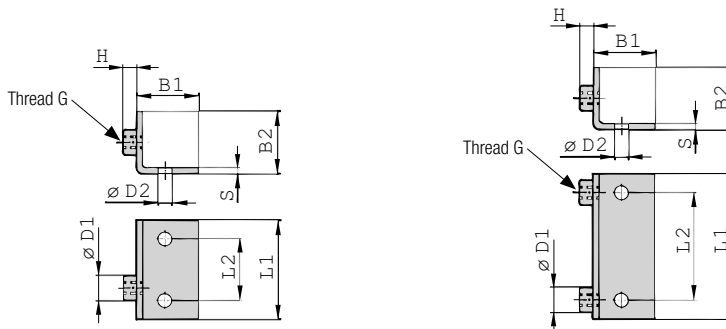

STAUFF Group 1

STAUFF Group 1A to 6

Ordering Codes

Weld Plate

***WSP-*1-*M-*W1**

- * Angled Weld Plate **WSP**
- * STAUFF Group **1**
- * Thread code Metric ISO thread **M**
Unified coarse (UNC) thread **U**
- * Material code Carbon Steel, zinc/nickel-plated **W3**
Stainless Steel V2A **W4**
1.4301 / 1.4305 (AISI 304 / 303)
Stainless Steel V4A **W5**
1.4401 / 1.4571 (AISI 316 / 316 Ti)

Group STAUFF	DIN	Dimensions (mm/in)								Ordering Codes (Standard Options)	
		Thread G	L1	L2	B1	B2	S	H	ØD1	ØD2	
1	0	M6	30	14	30	30	3	6,5	12	6,5	WSP-1-M-W1
		1/4-20 UNC	1.18	.55	1.18	1.18	.12	.26	.47	.26	WSP-1-U-W1
1A	1	M6	36	20	30	30	3	6,5	12	6,5	WSP-1A-M-W1
		1/4-20 UNC	1.26	.79	1.18	1.18	.12	.26	.47	.26	WSP-1A-U-W1
2	2	M6	42	26	30	30	3	6,5	12	6,5	WSP-2-M-W1
		1/4-20 UNC	1.65	1.02	1.18	1.18	.12	.26	.47	.26	WSP-2-U-W1
3	3	M6	50	33	30	30	3	6,5	12	6,5	WSP-3-M-W1
		1/4-20 UNC	1.97	1.30	1.18	1.18	.12	.26	.47	.26	WSP-3-U-W1
4	4	M6	60	40	30	30	3	6,5	12	6,5	WSP-4-M-W1
		1/4-20 UNC	2.36	1.57	1.18	1.18	.12	.26	.47	.26	WSP-4-U-W1
5	5	M6	70	52	30	30	3	6,5	12	6,5	WSP-5-M-W1
		1/4-20 UNC	2.76	2.05	1.18	1.18	.12	.26	.47	.26	WSP-5-U-W1
6	6	M6	88	66	30	30	3	6,5	12	6,5	WSP-6-M-W1
		1/4-20 UNC	3.46	2.60	1.18	1.18	.12	.26	.47	.26	WSP-6-U-W1

All threaded parts are available with Metric ISO thread or unified coarse (UNC) thread according to dimension table. Alternative materials and surface finishings are available upon request. Contact STAUFF for further information.

Bridge Weld Plate Type BSP

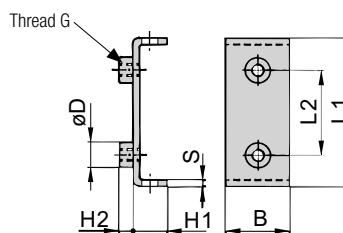

Ordering Codes

Weld Plate

***BSP-*1A-*M-*W1**

- * Bridge Weld Plate **BSP**
- * STAUFF Group **1A**
- * Thread code Metric ISO thread **M**
Unified coarse (UNC) thread **U**
- * Material code Carbon Steel, phosphated **W2**
Carbon Steel, zinc/nickel-plated **W3**
Stainless Steel V2A **W4**
1.4301 / 1.4305 (AISI 304 / 303)
Stainless Steel V4A **W5**
1.4401 / 1.4571 (AISI 316 / 316 Ti)

Group STAUFF	DIN	Dimensions (mm/in)								Ordering Codes (Standard Options)	
		Thread G	L1	L2	B	S	H1	H2	ØD		
1A	1	M6	48	20	30	3	13	6,5	12	6,5	BSP-1A-M-W1
		1/4-20 UNC	1.89	.79	1.18	.12	.52	.26	.47	.26	BSP-1A-U-W1
2	2	M6	54	26	30	3	13	6,5	12	6,5	BSP-2-M-W1
		1/4-20 UNC	2.13	1.02	1.18	.12	.52	.26	.47	.26	BSP-2-U-W1
3	3	M6	62	33	30	3	13	6,5	12	6,5	BSP-3-M-W1
		1/4-20 UNC	2.44	1.30	1.18	.12	.52	.26	.47	.26	BSP-3-U-W1
4	4	M6	71	40	30	3	13	6,5	12	6,5	BSP-4-M-W1
		1/4-20 UNC	2.80	1.57	1.18	.12	.52	.26	.47	.26	BSP-4-U-W1
5	5	M6	85	52	30	3	13	6,5	12	6,5	BSP-5-M-W1
		1/4-20 UNC	3.35	2.05	1.18	.12	.52	.26	.47	.26	BSP-5-U-W1
6	6	M6	98	66	30	3	13	6,5	12	6,5	BSP-6-M-W1
		1/4-20 UNC	3.86	2.60	1.18	.12	.52	.26	.47	.26	BSP-6-U-W1

All threaded parts are available with Metric ISO thread or unified coarse (UNC) thread according to dimension table. Alternative materials and surface finishings are available upon request. Contact STAUFF for further information.



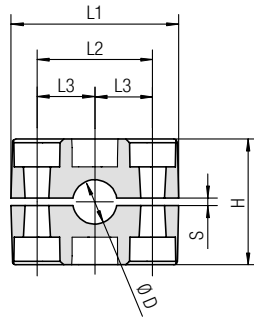

STAUFF Group 5

Group	Outside Diameter Pipe / Tube Ø D	Nominal Bore Pipe	Copper Tube ASTM B88	Ordering Codes (2 Clamp Halves) (** = Material)	Dimensions (mm/in)					
					L1	L2	L3	H	S min.	Width
5	20	1/2	3/4	520-**-MGR	2.80	2.05	1.02	2.28	0.03	1.18
	21,3			521.3-**-MGR						
	22			522-**-MGR						
	23			523-**-MGR						
	25	525-**-MGR								
	26,9	3/4	526.9-**-MGR							
	28	528-**-MGR								
	30	530-**-MGR								
	32	1-1/4	532-**-MGR							
	33,7	1	533.7-**-MGR							
	35	1-1/4	535-**-MGR							
	38	1-1/2	538-**-MGR							
	40	540-**-MGR								
	42	1-1/4	542-**-MGR							

Additional outside diameters are available upon request. Please contact STAUFF for further information.

Clamp Body for Multi-Group Weld Plate Type MGR



Ordering Codes

Clamp Body ***5*20-PP-MGR**

One clamp body is consisting of two clamp halves.

- * STAUFF Group **5**
- * Exact outside diameter Ø D1 (mm) **20**
- * Material code (see below) **PP-MGR**

Standard Materials

Polypropylene
Colour: Green
Material code: **PP-MGR**

Polyamide
Colour: Black
Material code: **PA-MGR**

See pages 154 / 155 for properties and technical information.

Multi-Group Weld Plates (type RAP-MGR) are designed to be used in combination with Standard Series clamp bodies, STAUFF Group 2 (regular types, see pages 14 ff.) covering a diameter range from 8 mm / .31 in to 18 mm / .71 in, as well as Standard Series clamp bodies, STAUFF Group 5 (type MGR, see above) covering a diameter range from 20 mm / .79 in to 42 mm / 1.65 in. Thus, all Standard Series metal parts (bolts, cover plates) of these groups can be used.



Multi-Group Weld Plate RAP-MGR-25-312-M-W1

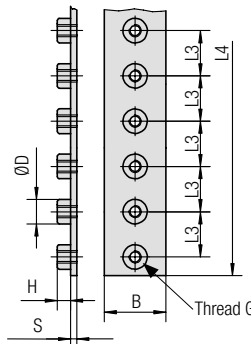

Number of Weld Nuts	Dimensions (mm/in)							Ordering Codes (Standard Options)
	Thread G	L3	L4	B	S	H	ØD	
6	M6	26	156	30	4	6,5	12	RAP-MGR-25-156-M-W1
	1/4-20 UNC	1.02	6.14	1.18	.16	.26	.47	RAP-MGR-25-156-U-W1
9	M6	26	234	30	4	6,5	12	RAP-MGR-25-234-M-W1
	1/4-20 UNC	1.02	9.21	1.18	.16	.26	.47	RAP-MGR-25-234-U-W1
12	M6	26	312	30	4	6,5	12	RAP-MGR-25-312-M-W1
	1/4-20 UNC	1.02	12.28	1.18	.16	.26	.47	RAP-MGR-25-312-U-W1
15	M6	26	390	30	4	6,5	12	RAP-MGR-25-390-M-W1
	1/4-20 UNC	1.02	15.35	1.18	.16	.26	.47	RAP-MGR-25-390-U-W1
20	M6	26	520	30	4	6,5	12	RAP-MGR-25-520-M-W1
	1/4-20 UNC	1.02	20.47	1.18	.16	.26	.47	RAP-MGR-25-520-U-W1
27	M6	26	700	30	4	6,5	12	RAP-MGR-25-700-M-W1
	1/4-20 UNC	1.02	27.55	1.18	.16	.26	.47	RAP-MGR-25-700-U-W1

Cover a diameter range from 8 mm (.31 in) to 42 mm (1.65 in) with only one Group Weld Plate!

All threaded parts are available with Metric ISO thread or unified coarse (UNC) thread according to dimension table. Alternative materials and surface finishings are available upon request. Contact STAUFF for further information.

Multi-Group Weld Plate for Clamp Body Sizes 2 and 5 (Type MGR) Type RAP-MGR



Ordering Codes

Weld Plate ***RAP-MGR-25-156-M-W1**

- * Multi Group Weld Plate **RAP-MGR**
- * Suitable for STAUFF Group 2 and 5 (only type MGR) **25**
- * Length L4 (mm)

156 (with 6 weld nuts)	156
234 (with 9 weld nuts)	234
312 (with 12 weld nuts)	312
390 (with 15 weld nuts)	390
520 (with 20 weld nuts)	520
700 (with 27 weld nuts)	700
- * Thread code

Metric ISO thread	M
Unified coarse (UNC) thread	U
- * Material code

Carbon Steel, uncoated	W1
Stainless Steel V4A 1.4401 / 1.4571 (AISI 316 / 316 Ti)	W5

Hexagon Rail Nut
(for Use with Mounting Rail TS)
Type SM

A

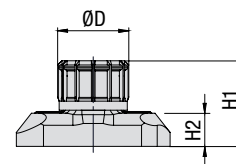
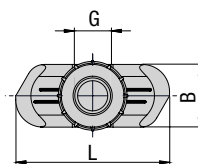
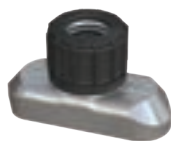

Ordering Codes

Hexagon Rail Nut *SM-1-8/1D-M-W3

- * Hexagon Rail Nut **SM**
- * STAUFF Group 1 to 8 (DIN Group 0 to 8) **1-8/1D**
- * Thread code Metric ISO thread **M**
Unified coarse (UNC) thread **U**
- * Material code Carbon Steel, zinc/nickel-plated **W3**
Stainless Steel V2A 1.4301 / 1.4305 (AISI 304 / 303) **W4**
Stainless Steel V4A 1.4401 / 1.4571 (AISI 316 / 316 Ti) **W5**

Group STAUFF	DIN	Dimensions (mm/in)						Ordering Codes (Standard Options)
		Thread G	L	B	H1	H2	ØD	
1	0							
1A	1							
2	2							
3	3							
4	4	M6	25,5	10,4	14,2	5,5	12	SM-1-8/1D-M-W3
		1/4-20 UNC	1.00	.41	.56	.22	.47	SM-1-8/1D-U-W3
5	5							
6	6							
7	7							
8	8							

Hexagon Rail Nuts, type SM-1-8/1D are also suitable for Twin Series, STAUFF Group 1D.

All threaded parts are available with Metric ISO thread or unified coarse (UNC) thread according to dimension table. Alternative materials and surface finishings are available upon request. Contact STAUFF for further information.

Mounting Rail
(for Use with Hexagon Rail Nut SM)
Type TS

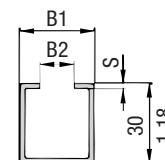
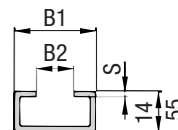
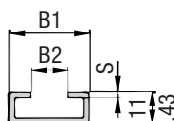

Mounting Rail TS-11

Mounting Rail TS-14

Mounting Rail TS-30

Ordering Codes

Mounting Rail *TS-11-1M-W1

- * Mounting Rail **TS**
- * Height of rail 11 mm / .43 in **11**
14 mm / .55 in **14**
30 mm / 1.18 in **30**
- * Length of rail 1 m / 3.28 ft **1M**
2 m / 6.56 ft **2M**
Alternative lengths available upon request. Contact STAUFF for further information.
- * Material code Carbon Steel, uncoated **W1**
Carbon Steel, hot-dip galvanised **W98**
Stainless Steel V2A 1.4301 / 1.4305 (AISI 304 / 303) **W4**
Stainless Steel V4A 1.4401 / 1.4571 (AISI 316 / 316 Ti) **W5**

Group STAUFF	DIN	Dimensions (mm/in)			Ordering Codes (Standard Options)	
		B1	B2	S	Length of Rail: 1 m / 3.28ft	Length of Rail: 2 m / 6.56ft
1	0					
1A	1				Height 11 mm / .43 in TS-11-1M-W1	Height 11 mm / .43 in TS-11-2M-W1
2	2					
3	3					
4	4	28	11	2	Height 14 mm / .55 in TS-14-1M-W1	Height 14 mm / .55 in TS-14-2M-W1
		1.10	.43	.08		
5	5					
6	6					
7	7				Height 30 mm / 1.18 in TS-30-1M-W1	Height 30 mm / 1.18 in TS-30-2M-W1
8	8					

Mounting Rails, type TS-11/14/30 are suitable for all Standard Series and Twin Series group sizes. Alternative materials and surface finishings are available upon request. Contact STAUFF for further information.

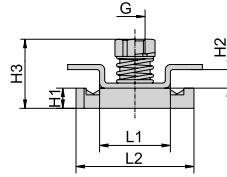
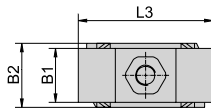

Channel Rail Adaptor (for Use with Various Channel Rails) Type CRA

A

Group STAUFF	DIN	Dimensions (mm/in)									Ordering Codes (Standard Options)	
		Thread G	L1	L2	L3	B1	B2	H1	H2	H3		
1	0											
1A	1											
2	2											
3	3											
4	4	M6	21	35	40	16	19	6	5,5	20,5	CRA-1-8/1D-M-W3	
		1/4-20 UNC	.83	1.38	1.57	.63	.75	.24	.22	.81	CRA-1-8/1D-U-W3	
5	5											
6	6											
7	7											
8	8											

Ordering Codes

Adaptor *CRA-1-8/1D-*M-*W3

* Channel Rail Adaptor		CRA
* STAUFF Group	1 to 8 (DIN Group 0 to 8)	1-8/1D
* Thread code	Metric ISO thread	M
	Unified coarse (UNC) thread	U
* Material code	Carbon Steel, zinc/nickel-plated	W3
	Stainless Steel V4A	W5
	1.4401 / 1.4571 (AISI 316 / 316 Ti)	

The Channel Rail Adaptor, type CRA 1-8/1D is also suitable for Twin Series, STAUFF Group 1D.

All threaded parts are available with Metric ISO thread or unified coarse (UNC) thread according to dimension table. Alternative materials and surface finishings are available upon request. Contact STAUFF for further information.

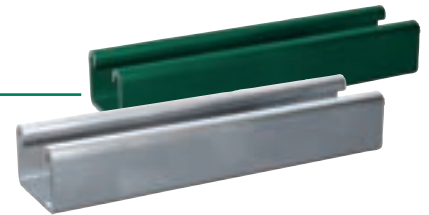

Compatibility with Channel Rails

The STAUFF Channel Rail Adaptor, type CRA, is suitable for various channel rails, including the following types:

HALFEN	HILTI	UNISTRUT®	STAUFF (Cushion Clamp Series)
HM 41/41	MQ-21, MQ-41, MQ-52, MQ-72	P1000, P1000T, P1000V, P1000VT, P1001	SCS-048-1-PL, SCS-048-1-GR
HZA 41/22	MQ-21U, MQ-41U, MQ-72U	P2000, P2000T	SCS-120-1-PL, SCS-120-1-GR
HZM 41/41	MQ-21D, MQ-41D, MQ-52-72D	P3003, P3003T, P3300V, P3300VT, P3301	See page 149 for technical information.
HZM 41/22		P4000, P4000T	
HL 41/41, HL 41/B2		P5000, P5000T, P5001, P5500, P5500T, P5501	

To check the compatibility with additional types of channel rail, please compare the dimensions with the following drawing before use.

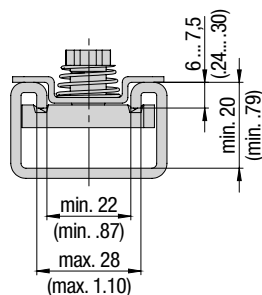

**Basic dimensional requirements for channel rails
to be used with STAUFF Channel Rail Adaptors, type CRA**

Dimensional drawings: All dimensions in mm (in).



Cover Plate
Type DP

A

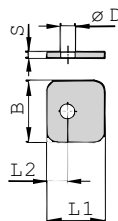

STAUFF Group 1

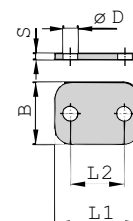

STAUFF Group 1A to 8

Ordering Codes

Cover Plate

***DP-*1-*W3**

* Cover Plate	DP
* STAUFF Group	1
* Material code	Carbon Steel, zinc/nickel-plated W3
	Stainless Steel V2A W4
	1.4301 / 1.4305 (AISI 304 / 303)
	Stainless Steel V4A W5
	1.4401 / 1.4571 (AISI 316 / 316 Ti)
	Aluminium EN AW-6060 W85

Group STAUFF	DIN	Dimensions (mm/in)					Ordering Codes (Standard Options)
		L1	L2	B	S	ØD	
1	0	28	9,5	30	3	7	DP-1-W3
		1.10	.37	1.18	.12	.28	
1A	1	34	20	30	3	7	DP-1A-W3
		1.34	.79	1.18	.12	.28	
2	2	40,5	26	30	3	7	DP-2-W3
		1.59	1.02	1.18	.12	.28	
3	3	48	33	30	3	7	DP-3-W3
		1.89	1.30	1.18	.12	.28	
4	4	57	40	30	3	7	DP-4-W3
		2.24	1.57	1.18	.12	.28	
5	5	70	52	30	3	7	DP-5-W3
		2.76	2.05	1.18	.12	.28	
6	6	86	66	30	3	7	DP-6-W3
		3.39	2.60	1.18	.12	.28	
7	7	118	94	30	5	7	DP-7-W3
		4.65	3.70	1.18	.20	.28	
8	8	144	120	30	5	7	DP-8-W3
		5.67	4.72	1.18	.20	.28	

Alternative materials and surface finishings are available upon request. Contact STAUFF for further information.

Hexagon Head Bolt

(for Use with Cover Plate DP)

Type AS

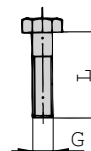

Hexagon Head Bolt AS (according to DIN 931 / 933 or ANSI / ASME B18.2.1.)
Dimensions applicable only when used with Cover Plate DP

Ordering Codes

Hexagon Head Bolt

***AS-*M6x30-*W3**

* Type of bolt	Hexagon Head Bolt (according to DIN 931 / 933 or ANSI / ASME B18.2.1.)	AS
* Thread type and size acc. to dimension table	M6x30	
* Material code	Carbon Steel, zinc/nickel-plated W3	
	Stainless Steel V2A W4	
	1.4301 / 1.4305 (AISI 304 / 303)	
	Stainless Steel V4A W5	
	1.4401 / 1.4571 (AISI 316 / 316 Ti)	

Group STAUFF	DIN	Dimensions (mm/in)		Ordering Codes (Standard Options)
		Thread G x L		
1	0	M6 x 30		AS-M6x30-W3
		1/4-20 UNC x 1-1/4		AS-1/4-20UNCx1-1/4-W3
1A	1	M6 x 30		AS-M6x30-W3
		1/4-20 UNC x 1-1/4		AS-1/4-20UNCx1-1/4-W3
2	2	M6 x 35		AS-M6x35-W3
		1/4-20 UNC x 1-3/8		AS-1/4-20UNCx1-3/8-W3
3	3	M6 x 40		AS-M6x40-W3
		1/4-20 UNC x 1-1/2		AS-1/4-20UNCx1-1/2-W3
4	4	M6 x 45		AS-M6x45-W3
		1/4-20 UNC x 1-7/8		AS-1/4-20UNCx1-7/8-W3
5	5	M6 x 60		AS-M6x60-W3
		1/4-20 UNC x 2-3/8		AS-1/4-20UNCx2-3/8-W3
6	6	M6 x 70		AS-M6x70-W3
		1/4-20 UNC x 2-3/4		AS-1/4-20UNCx2-3/4-W3
7	7	M6 x 100		AS-M6x100-W3
		1/4-20 UNC x 4		AS-1/4-20UNCx4-W3
8	8	M6 x 125		AS-M6x125-W3
		1/4-20 UNC x 4-7/8		AS-1/4-20UNCx4-7/8-W3

All threaded parts are available with Metric ISO thread or unified coarse (UNC) thread according to dimension table. Alternative materials and surface finishings are available upon request. Contact STAUFF for further information.



Safety Washer
(for Use with Hexagon Head Bolt AS)
Type SI (DIN 93)

A

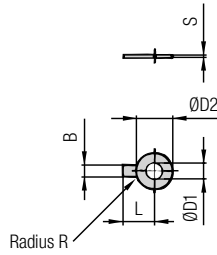

Safety Washer SI

(Bend longer tab down towards the side of the clamp body and one side up towards one of the flats of the hexagon head bolt)



Group STAUFF	DIN	Dimensions (mm / in)						Ordering Codes (Standard Options)
		ØD1	B	ØD2	L	R	S	
1 to 8	0 to 8	6,4	7	19	18	4	0,5	SI-6.4-DIN93-W3
		.25	.28	.75	.71	.16	.02	

Safety Washers, type SI are used as locking devices to prevent Hexagon Head Bolts, type AS from loosening. Safety Washers, type SI are suitable for all Standard Series group sizes.

Alternative materials and surface finishings are available upon request. Contact STAUFF for further information.

Ordering Codes

Safety Washer *SI-*6.4-*DIN93-*W3

- * Type of washer Safety washer with 1 tab (according to DIN 93) **SI-6.4-DIN93**
- * Material code Carbon Steel, zinc/nickel-plated **W3**
Stainless Steel V4A **W5**
1.4401 / 1.4571 (AISI 316 / 316 Ti)

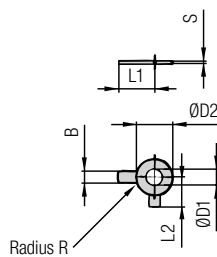

Safety Washer SI

(Bend longer tab down towards the side of the clamp body and shorter tab up towards one of the flats of the hexagon head bolt)

Safety Washer
(for Use with Hexagon Head Bolt AS)
Type SI (DIN 463)



Group STAUFF	DIN	Dimensions (mm / in)						Ordering Codes (Standard Options)	
		ØD1	B	ØD2	L1	L2	R		S
1 to 8	0 to 8	6,4	7	12	18	9	4	0,5	SI-6.4-DIN463-W3
		.25	.28	.47	.71	.35	.16	.02	

Safety Washers, type SI are used as locking devices to prevent Hexagon Head Bolts, type AS from loosening. Safety Washers, type SI are suitable for all Standard Series group sizes.

Alternative materials and surface finishings are available upon request. Contact STAUFF for further information.

Ordering Codes

Safety Washer *SI-*6.4-*DIN463-*W3

- * Type of washer Safety washer with 2 tabs (according to DIN 463) **SI-6.4-DIN463**
- * Material code Carbon Steel, zinc/nickel-plated **W3**
Stainless Steel V4A **W5**
1.4401 / 1.4571 (AISI 316 / 316 Ti)



Socket Cap Screw **Slotted Head Screw**
Type IS **Type LI**

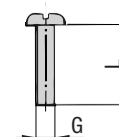
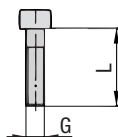

Socket Cap Screw IS

(according to ISO 4762 or ANSI / ASME B18.3)

Dimensions applicable only when used without Cover Plate DP

Slotted Head Screw LI

(according to ISO 1207 or ANSI / ASME B18.6.3)

Dimensions applicable only when used without Cover Plate DP

Ordering Codes

Socket Cap Screw ***IS-*M6x30-*W3**
Slotted Head Screw ***LI-*M6x30-*W3**

* Type of bolt Socket Cap Screw (according to ISO 4762 or ANSI / ASME B18.3) **IS**
Slotted Head Screw (according to ISO 1207 or ANSI / ASME B18.6.3) **LI**

Please note: Socket cap screws IS and slotted head screws LI have to be used in conjunction with washers US, which are available separately.

* Thread type and size acc. to dimension table **M6x30**

* Material code Carbon Steel, zinc/nickel-plated **W3**
Stainless Steel V2A **W4**
1.4301 / 1.4305 (AISI 304 / 303)
Stainless Steel V4A **W5**
1.4401 / 1.4571 (AISI 316 / 316 Ti)

Group STAUFF	DIN	Dimensions (mm/m) Thread G x L	Ordering Codes (Standard Options)	
			Socket Cap Screws	Slotted Head Screws
1	0	M6 x 20	IS-M6x20-W3	LI-M6x20-W3
		1/4-20 UNC x 3/4	IS-1/4-20UNCx3/4-W3	LI-1/4-20UNCx3/4-W3
1A	1	M6 x 20	IS-M6x20-W3	LI-M6x20-W3
		1/4-20 UNC x 3/4	IS-1/4-20UNCx3/4-W3	LI-1/4-20UNCx3/4-W3
2	2	M6 x 25	IS-M6x25-W3	LI-M6x25-W3
		1/4-20 UNC x 1	IS-1/4-20UNCx1-W3	LI-1/4-20UNCx1-W3
3	3	M6 x 30	IS-M6x30-W3	LI-M6x30-W3
		1/4-20 UNC x 1-1/8	IS-1/4-20UNCx1-1/8-W3	LI-1/4-20UNCx1-1/8-W3
4	4	M6 x 35	IS-M6x35-W3	LI-M6x35-W3
		1/4-20 UNC x 1-3/8	IS-1/4-20UNCx1-3/8-W3	LI-1/4-20UNCx1-3/8-W3
5	5	M6 x 50	IS-M6x50-W3	LI-M6x50-W3
		1/4-20 UNC x 2	IS-1/4-20UNCx2-W3	LI-1/4-20UNCx2-W3
6	6	M6 x 60	IS-M6x60-W3	LI-M6x60-W3
		1/4-20 UNC x 2-1/2	IS-1/4-20UNCx2-1/2-W3	LI-1/4-20UNCx2-1/2-W3
7	7	M6 x 90	IS-M6x90-W3	ON REQUEST ONLY
		1/4-20 UNC x 3-3/8	IS-1/4-20UNCx3-3/8-W3	ON REQUEST ONLY
8	8	M6 x 110	IS-M6x110-W3	ON REQUEST ONLY
		1/4-20 UNC x 4-3/8	IS-1/4-20UNCx4-3/8-W3	ON REQUEST ONLY

All threaded parts are available with Metric ISO thread or unified coarse (UNC) thread according to dimension table. Alternative materials and surface finishings are available upon request. Contact STAUFF for further information.

Hexagon Head Bolt **Insert**
Type AS **Type ES / EP**

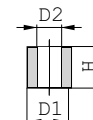
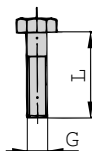

Hexagon Head Bolt AS

(according to DIN 931 / 933 or ANSI / ASME B18.2.1.)

Dimensions applicable only when used with Inserts EP / ES

Insert EP (Polypropylene)

Insert ES-W3 (Steel, zinc/nickel-plated)

Insert ES-W5 (Stainless Steel V4A)

Ordering Codes

Hexagon Head Bolt ***AS-*M6x27-*W3**

* Type of bolt Hexagon Head Bolt (according to DIN 931 / 933 or ANSI / ASME B18.2.1.) **AS**

* Thread type and size acc. to dimension table **M6x27**

* Material code Carbon Steel, zinc/nickel-plated **W3**
Stainless Steel V2A **W4**
1.4301 / 1.4305 (AISI 304 / 303)
Stainless Steel V4A **W5**
1.4401 / 1.4571 (AISI 316 / 316 Ti)

Group STAUFF	DIN	Dimensions (mm/m) Thread G x L	Ordering Codes (Standard Options)		Group STAUFF	DIN	Dimensions (mm/m)				Ordering Codes (Standard Options)	
			D1	D2			H ES	H EP	ES-W3	EP		
1	0	M6 x 27	AS-M6x27-W3		1 to 8	0 to 8	11,8 .46	6,5 .26	7,8 .31	8,6 .34	ES-W3	EP
		1/4-20 UNC x 1-1/8	AS-1/4-20UNCx1-1/8-W3									
1A	1	M6 x 27	AS-M6x27-W3									
		1/4-20 UNC x 1-1/8	AS-1/4-20UNCx1-1/8-W3									
2	2	M6 x 32	AS-M6x32-W3									
		1/4-20 UNC x 1-3/8	AS-1/4-20UNCx1-3/8-W3									
3	3	M6 x 35	AS-M6x35-W3									
		1/4-20 UNC x 1-3/8	AS-1/4-20UNCx1-3/8-W3									
4	4	M6 x 42	AS-M6x42-W3									
		1/4-20 UNC x 1-5/8	AS-1/4-20UNCx1-5/8-W3									
5	5	M6 x 57	AS-M6x57-W3									
		1/4-20 UNC x 2-3/8	AS-1/4-20UNC-2-3/8-W3									
6	6	M6 x 65	AS-M6x65-W3									
		1/4-20 UNC x 2-3/4	AS-1/4-20UNCx2-3/4-W3									
7	7	M6 x 95	AS-M6x95-W3									
		1/4-20 UNC x 4	AS-1/4-20UNCx4-W3									
8	8	M6 x 118	AS-M6x118-W3									
		1/4-20 UNC x 4-3/4	AS-1/4-20UNCx4-3/4-W3									

All threaded parts are available with Metric ISO thread or unified coarse (UNC) thread according to dimension table. Alternative materials and surface finishings are available upon request. Contact STAUFF for further information.



Safety Locking Plate
(for Use with Stacking Bolt AF)
Type SIG

A

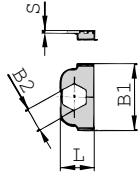

STAUFF Group 1

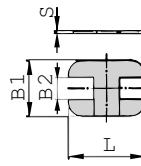

STAUFF Group 1A to 8



Group STAUFF	DIN	Dimensions (mm/in)				Ordering Codes (Standard Options)
		L	B1	B2	S	
1	0	16	32	11,2	1	SIG-1-W3
		.63	1.26	.44	.04	
1A	1	33	28	11,2	1	SIG-1A-W3
		1.30	1.10	.44	.04	
2	2	39	28	11,2	1	SIG-2-W3
		1.54	1.10	.44	.04	
3	3	47	28	11,2	1	SIG-3-W3
		1.85	1.10	.44	.04	
4	4	56	28	11,2	1	SIG-4-W3
		2.20	1.10	.44	.04	
5	5	69	28	11,2	1	SIG-5-W3
		2.72	1.10	.44	.04	
6	6	85	28	11,2	1	SIG-6-W3
		3.35	1.10	.44	.04	
7	7	117	28	11,2	1	SIG-7-W3
		4.61	1.10	.44	.04	
8	8	143	28	11,2	1	SIG-8-W3
		5.63	1.10	.44	.04	

Ordering Codes

Safety Locking Plate *SIG-*1-*W3

- * Safety Locking Plate **SIG**
- * STAUFF Group **1**
- * Material code Carbon Steel, zinc/nickel-plated **W3**
- Stainless Steel V2A **W4**
- 1.4301 / 1.4305 (AISI 304 / 303)
- Stainless Steel V4A **W5**
- 1.4401 / 1.4571 (AISI 316 / 316 Ti)

Alternative materials and surface finishings are available upon request. Contact STAUFF for further information.

Stacking Bolt
(for Use with Safety Locking Plate SIG)
Type AF

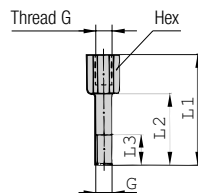

Group STAUFF	DIN	Dimensions (mm/in)					Ordering Codes (Standard Options)
		Thread G	L1	L2	L3 min.	Hex	
1	0	M6	34	20	12	11	AF-1/1A/1D-M-W3
		1/4-20 UNC	1.34	.79	.47	.43	AF-1/1A/1D-U-W3
1A	1	M6	34	20	12	11	AF-1/1A/1D-M-W3
		1/4-20 UNC	1.34	.79	.47	.43	AF-1/1A/1D-U-W3
2	2	M6	40	25	12	11	AF-2-M-W3
		1/4-20 UNC	1.57	.98	.47	.43	AF-2-U-W3
3	3	M6	44	30	12	11	AF-3-M-W3
		1/4-20 UNC	1.73	1.18	.47	.43	AF-3-U-W3
4	4	M6	49	35	12	11	AF-4-M-W3
		1/4-20 UNC	1.93	1.38	.47	.43	AF-4-U-W3
5	5	M6	64	50	12	11	AF-5-M-W3
		1/4-20 UNC	2.52	1.97	.47	.43	AF-5-U-W3
6	6	M6	74	60	12	11	AF-6-M-W3
		1/4-20 UNC	2.91	2.36	.47	.43	AF-6-U-W3
7	7	M6	99	85	12	11	AF-7-M-W3
		1/4-20 UNC	3.90	3.35	.47	.43	AF-7-U-W3
8	8	M6	124	110	12	11	AF-8-M-W3
		1/4-20 UNC	4.88	4.33	.47	.43	AF-8-U-W3

Ordering Codes

Stacking Bolt *AF-*1/1A/1D-*M-*W3

- * Type of bolt Stacking Bolt (according to STAUFF Standard) **AF**
- * STAUFF Group **1**
- * Thread code Metric ISO thread **M**
- Unified coarse (UNC) thread **U**
- * Material code Carbon Steel, zinc/nickel-plated **W3**
- Stainless Steel V2A **W4**
- 1.4301 / 1.4305 (AISI 304 / 303)
- Stainless Steel V4A **W5**
- 1.4401 / 1.4571 (AISI 316 / 316 Ti)

All threaded parts are available with Metric ISO thread or unified coarse (UNC) thread according to dimension table. Alternative materials and surface finishings are available upon request. Contact STAUFF for further information.



A



① Type of Installation

Please select the type of installation (e.g. Weld Plates, Rail Nuts etc.) and add the corresponding Code to position ① of the order code for your clamp assembly.

Without Installation Equipment
Code: **none**

Installation on Weld Plate

Single Weld Plate
Code: **SP**

Elongated Weld Plate
Code: **SPV**

Twin Weld Plate (for STAUFF Group 1 to 6 only)
Code: **DSP**

Group Weld Plate (for STAUFF Group 1 to 6 only)
Code: **RAP**

Angled Weld Plate (for STAUFF Group 1 to 6 only)
Code: **WSP**

Bridge Weld Plate (for STAUFF Group 1A to 6 only)
Code: **BSP**

Installation on Mounting / Channel Rail

Hexagon Rail Nut
Code: **SM**

Channel Rail Adaptor
Code: **CRA**

② Group Size & Diameter

Please select the required group size and diameter and add the corresponding Code to position ② of the order code for your clamp assembly.

Group STAUFF (DIN)	Outside Diameter P / T / H (mm)	Availability of Clamp Body Materials & Designs			Code
		Profiled Design	Type H	Type RI	
1 (0)	6	●	●	○	106
	6,4	●	●	○	106.4
	8	●	●	○	108
	9,5	●	●	○	109.5
	10	●	●	○	110
1A (1)	12	●	●	○	112
	6	●	●	○	106A
	6,4	●	●	○	106.4A
	8	●	●	○	108A
	9,5	●	●	○	109.5A
2 (2)	10	●	●	○	110A
	12	●	●	○	112A
	12,7	●	●	○	212.7
	13,5	●	●	○	213.5
	14	●	●	○	214
	15	●	●	○	215
	16	●	●	○	216
3 (3)	17,2	●	●	○	217.2
	18	●	●	○	218
	19	●	●	○	319
	20	●	●	○	320
	21,3	●	●	○	321.3
4 (4)	22	●	●	○	322
	25	●	●	○	325
	25,4	●	●	○	325.4
	6	○	○	●	406
	8	○	○	●	408
	10	○	○	●	410
	12	○	○	●	412
	12,7	○	○	●	412.7
	14	○	○	●	414
	15	○	○	●	415
	16	○	○	●	416
	17,2	○	○	●	417.2
	18	○	○	●	418
	19	○	○	●	419
	26,9	●	●	○	426.9
	28	●	●	○	428
	28,6	●	○	○	428.6
30	●	●	○	430	
32	●	●	○	432	

Group STAUFF (DIN)	Outside Diameter P / T / H (mm)	Availability of Clamp Body Materials & Designs			Code
		Profiled Design	Type H	Type RI	
5 (5)	32	●	●	○	532
	33,7	●	●	○	533.7
	35	●	●	○	535
	38	●	●	○	538
	40	●	●	○	540
	41,3	●	○	○	541.3
	42	●	●	○	542
	20	○	○	●	620
	21,3	○	○	●	621.3
	22	○	○	●	622
6 (6)	25	○	○	●	625
	26,9	○	○	●	626.9
	28	○	○	●	628
	30	○	○	●	630
	32	○	○	●	632
	44,5	●	●	○	644.5
	48,3	●	●	○	648.3
	50,8	●	●	○	650.8
	54	●	●	○	654
	57,2	●	●	○	757.2
7 (7)	60,3	●	●	○	760.3
	63,5	●	●	○	763.5
	70	●	●	○	770
	73	●	●	○	773
	76,1	●	●	○	776.1
8 (8)	88,9	●	●	○	888.9
	102	●	●	○	8102L

● Standard Option



Please see pages 32 and 33 with detailed order examples for some of the most popular Standard Series clamp assemblies.

③ Clamp Body Design & Material

Please select the design and material of your clamp body and add the corresponding **Code** to position ③ of the order code for your clamp assembly.

Please check the availability of the selected clamp body design and material according to the matrix table in ②.

Profiled Design



Polypropylene
Code: **PP**



Polypropylene (Colour: Black)
Code: **PP-BK**



Polyamide
Code: **PA**



Thermoplastic Elastomer (87 Shore-A)
Code: **SA**



Aluminium
Code: **AL** (for STAUFF Group 1A to 6 only)

Type H (Smooth)



Polypropylene
Code: **PP-H**



Polypropylene (Colour: Black)
Code: **PP-H-BK**



Polyamide
Code: **PA-H**



Thermoplastic Elastomer (87 Shore-A)
Code: **SA-H**

Type RI (with Elastomer Insert)



Polypropylene
Code: **PP-R** (for STAUFF Group 4 and 6 only)



Polyamide
Code: **PA-R** (for STAUFF Group 4 and 6 only)

See pages 154 / 155 for material properties and technical information.

Please contact STAUFF for further details on fire-proof clamp body materials, tested and approved according to several international fire-protection standards.

④ Mounting & Fitting Combination

Please select the mounting and fitting combination (e.g. bolts, screws, cover plates etc.) and add the corresponding **Code** to position ④ of the order code for your clamp assembly.

Installation with Cover Plate and Bolts

Cover Plate DP with
Hexagon Head Bolts AS
Code: **DP-AS**

Cover Plate DP with
Socket Cap Screws IS*
Code: **DP-IS**

Installation with Locking Plate and Bolts

Safety Locking Plate SIG with
Stacking Bolts AF
Code: **SIG-AF**

Installation with Inserts and Bolts

Inserts EP (Plastic) with
Hexagon Head Bolts AS
Code: **EP-AS**

Inserts ES (Steel) with
Hexagon Head Bolts AS
Code: **ES-AS**

Installation with Bolts only

Socket Cap Screws IS (Washers US included)
Code: **IS**

Slotted Head Screws LI (Washers US included)
Code: **LI** (for STAUFF Group 1 to 6 only)

* Special lengths of Socket Cap Screws IS required.
For exact lengths, please see details of Hexagon Head Bolt, type AS

⑤ Thread Type

Please select the required thread type and add the corresponding **Code** to position ⑤ of the order code for your clamp assembly.

Metric ISO thread
Code: **M**

Unified coarse (UNC) thread
Code: **U**

All threaded parts are available with Metric ISO thread or unified coarse (UNC) thread according to dimension table.

⑥ Material & Surface Finishing

Please select the required material & surface finishing of the metal parts and add the corresponding **Code** to position ⑥ of the order code for your clamp assembly.

Metal parts made of Carbon Steel, zinc/nickel-plated **W3**

Metal parts made of Stainless Steel V2A
1.4301 / 1.4305 (AISI 304 / 303) **W4**

Metal parts made of Stainless Steel V4A
1.4401 / 1.4571 (AISI 316 / 316 Ti) **W5**

Weld Plate made of Carbon Steel, phosphated; Other metal parts made of Carbon Steel, zinc/nickel-plated **W10**

Individual combinations of alternative materials and surface finishings are available upon request. Contact STAUFF for further information.

⑦ Assembling & Kitting

If required, please select an additional assembling and kitting option and add the corresponding **Code** to the last position of the order code for your clamp assembly.

Components supplied separately
Code: **none** (standard option)

Components assembled
Code: **A** (special option)

Components packed in kits
Code: **K** (special option)



A



- 2x **Hexagon Head Bolt**
Surface: W3
Thread: Metric
- 1x **Cover Plate**
Surface: W3
- 1x **Clamp Body** (two halves)
STAUFF Group 2 (DIN 2)
O.D. 12,7 mm / .50 in
Material: Polypropylene
Profiled inside surface
with tension clearance
- 1x **Single Weld Plate**
Surface: W2
Thread: Metric

Order Code

SP-212.7-PP-DP-AS-M-W10

W10 is the standard option for this type of installation.



- 2x **Socket Cap Screw**
with Washer
Surface: W3
Thread: Metric
- 1x **Clamp Body** (two halves)
STAUFF Group 2 (DIN 2)
O.D. 12,7 mm / .50 in
Material: Polypropylene
Profiled inside surface
with tension clearance
- 1x **Single Weld Plate**
Surface: W2
Thread: Metric

Order Code

SP-212.7-PP-IS-M-W10

W10 is the standard option for this type of installation.



- 2x **Slotted Head Screw**
with Washer
Surface: W3
Thread: Metric
- 1x **Clamp Body** (two halves)
STAUFF Group 2 (DIN 2)
O.D. 12,7 mm / .50 in
Material: Polypropylene
Profiled inside surface
with tension clearance
- 1x **Single Weld Plate**
Surface: W2
Thread: Metric

Order Code

SP-212.7-PP-LI-M-W10

W10 is the standard option for this type of installation.
Available up to STAUFF Group 6 (DIN Group 6) only.



- 2x **Hexagon Head Bolt**
Surface: W3
Thread: Metric
- 1x **Cover Plate**
Surface: W3
- 1x **Clamp Body** (two halves)
STAUFF Group 2 (DIN 2)
O.D. 12,7 mm / .50 in
Material: Polypropylene
Profiled inside surface
with tension clearance
- 1x **Elongated Weld Plate**
Surface: W2
Thread: Metric

Order Code

SPV-212.7-PP-DP-AS-M-W10

W10 is the standard option for this type of installation.



- 2x **Socket Cap Screw**
with Washer
Surface: W3
Thread: Metric
- 1x **Clamp Body** (two halves)
STAUFF Group 2 (DIN 2)
O.D. 12,7 mm / .50 in
Material: Polypropylene
Profiled inside surface
with tension clearance
- 1x **Elongated Weld Plate**
Surface: W2
Thread: Metric

Order Code

SPV-212.7-PP-IS-M-W10

W10 is the standard option for this type of installation.



- 2x **Slotted Head Screw**
with Washer
Surface: W3
Thread: Metric
- 1x **Clamp Body** (two halves)
STAUFF Group 2 (DIN 2)
O.D. 12,7 mm / .50 in
Material: Polypropylene
Profiled inside surface
with tension clearance
- 1x **Elongated Weld Plate**
Surface: W2
Thread: Metric

Order Code

SPV-212.7-PP-LI-M-W10

W10 is the standard option for this type of installation.
Available up to STAUFF Group 6 (DIN Group 6) only.



- 2x **Hexagon Head Bolt**
Surface: W3
Thread: Metric
- 1x **Cover Plate**
Surface: W3
- 1x **Clamp Body** (two halves)
STAUFF Group 2 (DIN 2)
O.D. 12,7 mm / .50 in
Material: Polypropylene
Profiled inside surface
with tension clearance
- 2x **Hexagon Rail Nut**
Surface: W3
Thread: Metric

Order Code (Mounting Rail TS not included.)

SM-212.7-PP-DP-AS-M-W3

W3 is the standard option for this type of installation.



- 2x **Socket Cap Screw**
with Washer
Surface: W3
Thread: Metric
- 1x **Clamp Body** (two halves)
STAUFF Group 2 (DIN 2)
O.D. 12,7 mm / .50 in
Material: Polypropylene
Profiled inside surface
with tension clearance
- 2x **Hexagon Rail Nut**
Surface: W3
Thread: Metric

Order Code (Mounting Rail TS not included.)

SM-212.7-PP-IS-M-W3

W3 is the standard option for this type of installation.



- 2x **Slotted Head Screw**
with Washer
Surface: W3
Thread: Metric
- 1x **Clamp Body** (two halves)
STAUFF Group 2 (DIN 2)
O.D. 12,7 mm / .50 in
Material: Polypropylene
Profiled inside surface
with tension clearance
- 2x **Hexagon Rail Nut**
Surface: W3
Thread: Metric

Order Code (Mounting Rail TS not included.)

SM-212.7-PP-LI-M-W3

W3 is the standard option for this type of installation.
Available up to STAUFF Group 6 (DIN Group 6) only.





- 2x **Hexagon Head Bolt**
Surface: W3
Thread: Metric
- 1x **Cover Plate**
Surface: W3
- 1x **Clamp Body** (two halves)
STAUFF Group 2 (DIN 2)
O.D. 12,7 mm / .50 in
Material: Polypropylene
Profiled inside surface
with tension clearance

Order Code
212.7-PP-DP-AS-M-W3
W3 is the standard option for this type of installation.

- 2x **Socket Cap Screw**
with Washer
Surface: W3
Thread: Metric
- 1x **Clamp Body** (two halves)
STAUFF Group 2 (DIN 2)
O.D. 12,7 mm / .50 in
Material: Polypropylene
Profiled inside surface
with tension clearance

Order Code
212.7-PP-IS-M-W3
W3 is the standard option for this type of installation.

- 2x **Slotted Head Screw**
with Washer
Surface: W3
Thread: Metric
- 1x **Clamp Body** (two halves)
STAUFF Group 2 (DIN 2)
Tube-O.D. 12,7 mm / .50 in
Material: Polypropylene
Profiled inside surface
with tension clearance

Order Code
212.7-PP-LI-M-W3
W3 is the standard option for this type of installation.

- 2x **Stacking Bolt**
Surface: W3
Thread: Metric
- 1x **Safety Locking Plate**
Surface: W3
- 1x **Clamp Body** (two halves)
STAUFF Group 2 (DIN 2)
O.D. 12,7 mm / .50 in
Material: Polypropylene
Profiled inside surface
with tension clearance

Order Code
212.7-PP-SIG-AF-M-W3
W3 is the standard option for this type of installation.

- 1x **Socket Cap Screw**
with Washer
Surface: W3
Thread: Metric
- 1x **Clamp Body** (two halves)
STAUFF Group 1 (DIN 0)
O.D. 6 mm / .24 in
Material: Polypropylene
Profiled inside surface
with tension clearance
Thread: Metric
- 1x **Single Weld Plate**
Surface: W2
Thread: Metric

Order Code*
SP-106-PP-IS-M-W10
W10 is the standard option for this type of installation.

Thread codes

All threaded parts are available with Metric ISO thread or unified coarse (UNC) thread according to dimension table.

Metric ISO thread	M
Unified coarse (UNC) thread	U

Material codes

The below listed material codes describe the materials and surface finishings of metal parts that are most relevant for Standard Series clamp assemblies. Individual combinations of alternative materials and surface finishings are available upon request. Contact STAUFF for further information.

Metal parts made of Carbon Steel, zinc/nickel-plated	W3
Metal parts made of Stainless Steel V2A 1.4301 / 1.4305 (AISI 304 / 303)	W4
Metal parts made of Stainless Steel V4A 1.4401 / 1.4571 (AISI 316 / 316 Ti)	W5
Weld Plate made of Carbon Steel, phosphated; Other metal parts made of Carbon Steel, zinc/nickel-plated	W10

Technical Notes

* Because of their design, STAUFF Group 1 (DIN Group 0) clamp assemblies only include one single bolt / screw.





















- 2x **Hexagon Head Bolt**
Surface: W3
Thread: Metric
- 2x **Insert**
Material: Plastic
- 1x **Clamp Body** (two halves)
STAUFF Group 2 (DIN 2)
O.D. 12,7 mm / .50 in
Material: Polypropylene
Profiled inside surface
with tension clearance
- 1x **Single Weld Plate**
Surface: W2
Thread: Metric

Order Code
SP-212.7-PP-EP-AS-M-W10
W10 is the standard option for this type of installation.

- 2x **Hexagon Head Bolt**
Surface: W3
Thread: Metric
- 2x **Insert**
Material: Plastic
- 1x **Clamp Body** (two halves)
STAUFF Group 2 (DIN 2)
O.D. 12,7 mm / .50 in
Material: Polypropylene
Profiled inside surface
with tension clearance
- 1x **Elongated Weld Plate**
Surface: W2
Thread: Metric

Order Code
SPV-212.7-PP-EP-AS-M-W10
W10 is the standard option for this type of installation.





	Clamp Body Profiled Inside Surface with Tension Clearance	36		Weld Plate for Single Clamps SPAL	40
	Clamp Body Smooth Inside Surface without Tension Clearance	38		Weld Plate for Double Clamps SPAS	40
	Clamp Body with Elastomer Insert	39		Elongated Weld Plate for Single Clamps SPAL-DUEB	41
				Elongated Weld Plate for Double Clamps SPAS-DUEB	41
				Mounting Rail Nut GMV	42
				Mounting Rail STSV	42
				Channel Rail Adaptor CRA	43
				Cover Plate for Single Clamps DPAL	44
				Cover Plate for Double Clamps DPAL	44
				Hexagon Head Bolt AS	45
				Socket Cap Screw IS	45
				Safety Washer (DIN 93) SI	46
				Safety Washer (DIN 463) SI	46
				Safety Locking Plate SIP	47
				Stacking Bolt AF	47
				Clamp Assemblies	48

B

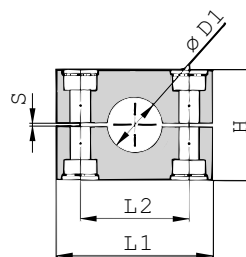
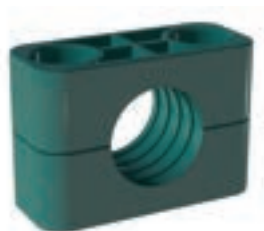

Clamp Body - Profiled Design

Profiled Inside Surface with Tension Clearance



B

Ordering Codes

Clamp Body

***3*006-*PP**

One clamp body is consisting of two clamp halves.

- * 1st part of STAUFF Group **3**
- * Exact outside diameter Ø D1 (mm) **006**
- * Material code (see below) **PP**

Standard Materials



Polypropylene
Colour: Green
Material code: **PP**



Polypropylene
Colour: Black
Material code: **PP-BK**



Polyamide
Colour: Black
Material code: **PA**



Thermoplastic Elastomer (87 Shore-A)
Colour: Black
Material code: **SA**



Aluminium
Colour: Self-Colour
Material code: **AL**

See pages 154 / 155 for material properties and technical information.

Special Materials

Please contact STAUFF for further details on fire-proof clamp body materials, tested and approved according to several international fire-protection standards (such as BS 6853, EN 45545-2, UL 94 and many more).

See pages 156 / 157 for material properties and technical information.

Product Features

- Proven, tested and trusted product in various markets
- Recommended for the safe installation of rigid pipes and tubes
- Available for all commonly used pipe and tube outside diameters
- Environmental protection due to vibration/noise reducing design
- Excellent weathering resistance, even under extreme conditions

Group	STAUFF	DIN	Outside Diameter		Nominal Bore		Ordering Codes (2 Clamp Halves) (** = Material)	Dimensions (mm/in)					
			Pipe / Tube Ø D1 (mm)	(in)	Pipe (in)	Copper Tube ASTM B88 (in)		L1 PP/PA/SA	L1 AL	L2	H	S min.	Width
3S	1	6					3006-**-**	55	56	33	32	0,6	30,5
		6,4	1/4			3006.4-**-**							
		8	5/16			3008-**-**							
		9,5	3/8	1/4		3009.5-**-**							
		10		1/8		3010-**-**							
		12				3012-**-**							
		12,7	1/2	3/8		3012.7-**-**							
		13,5		1/4		3013.5-**-**							
		14				3014-**-**							
		15				3015-**-**							
		16	5/8	1/2		3016-**-**							
		17,2		3/8		3017.2-**-**							
		18				3018-**-**							
		20				3020-**-**							
4S	2	19	3/4			4019-**-**	70	70	45	48	0,6	30,5	
		20				4020-**-**							
		21,3		1/2		4021.3-**-**							
		22	7/8	3/4		4022-**-**							
		25				4025-**-**							
		25,4	1			4025.4-**-**							
		26,9		3/4		4026.9-**-**							
		28				4028-**-**							
		30				4030-**-**							
		30				5030-**-**							
5S	3	32	1-1/4			5032-**-**	85	85	60	60	0,6	30,5	
		33,7		1		5033.7-**-**							
		35		1-1/4		5035-**-**							
		38	1-1/2			5038-**-**							
		40				5040-**-**							
		41,3		1-1/2		5041.3-**-**							
		42		1-1/4		5042-**-**							
		38	1-1/2			6038-**-**							
		42		1-1/4		6042-**-**							
		44,5	1-3/4			6044.5-**-**							
6S	4	48,3		1-1/2		6048.3-**-**	115	120	90	89	2	45	
		50,8	2			6050.8-**-**							
		54		2		6054-**-**							
		55				6055-**-**							
		57				6057-**-**							
		57,2	2-1/4			6057.2-**-**							
		60,3		2		6060.3-**-**							
		63,5	2-1/2			6063.5-**-**							
		65				6065-**-**							
		70	2-3/4			6070-**-**							

See page 37 for STAUFF Group 7S to 12S (DIN Group 5 to 10).

Additional outside diameters are available upon request. Please contact STAUFF for further information.



Clamp Body - Profiled Design

Profiled Inside Surface with Tension Clearance

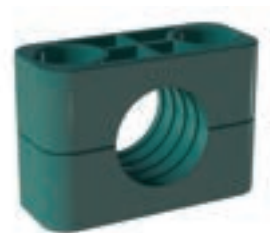
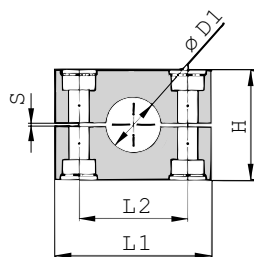

B

Group	DIN	Outside Diameter		Nominal Bore	Ordering Codes (2 Clamp Halves) (** = Material)	Dimensions (mm/in)					
		Pipe / Tube Ø D1 (mm)	(in)			Pipe (in)	L1 PP/PA	L1 AL	L2	H	S min.
7S	5	60,3			7060.3-***	154	152	122	120	2	60
		65			7065-***						
		70	2-3/4		7070-***						
		73		2-1/2 (ANSI B 36-10)	7073-***						
		75			7075-***						
		76,1	3	2-1/2 (DIN EN 10220)	7076.1-***						
		80			7080-***						
		82,5			7082.5-***						
8S	6	88,9	3-1/2	3	7088.9-***	206	208	168	168	2	80
		88,9	3-1/2	3	8088.9-***						
		100			8100-***						
		102	4	3-1/2	8102-***						
		108			8108-***						
		114	4-1/2	4	8114-***						
		127	5		8127-***						
		133			8133-***						
9S	7	127	5		9127-***	251	255	205	200	3	91
		133			9133-***						
		140		5	9140-***						
		152	6		9152-***						
		159			9159-***						
		165			9165-***						
10S	8	168		6	9168-***	336	326	265	270	3	120
		177,8			10168-***						
		193,7			10177.8-***						
		203	8		10193.7-***						
		216			10203-***						
11S	9	219		8	10216-***	470	470	395	410	8	162
		219			10219-***						
		273		10	11219-***						
12S	10	324		12	11273-***	18.50	18.50	15.55	16.14	.31	6.38
		356		14	11324-***						
		406		16	12356-***						
					12406-***	24.80	24.80	21.02	20.87	.79	7.16

Ordering Codes

Clamp Body *7*060.3-*PP

One clamp body is consisting of two clamp halves.

* 1st part of STAUFF Group **7**
 * Exact outside diameter Ø D1 (mm) **060.3**
 * Material code (see below) **PP**

Standard Materials

- Polypropylene**
Colour: Green
Material code: **PP**
- Polypropylene**
Colour: Black
Material code: **PP-BK**
- Polyamide**
Colour: Black
Material code: **PA**
- Aluminium**
Colour: Self-Colour
Material code: **AL**

See pages 154 / 155 for material properties and technical information.

Special Materials

Please contact STAUFF for further details on fire-proof clamp body materials, tested and approved according to several international fire-protection standards (such as BS 6853, EN 45545-2, UL 94 and many more).

See page 36 for STAUFF Group 3S to 6S (DIN Group 1 to 4).

Additional outside diameters are available upon request. Please contact STAUFF for further information.

See pages 156 / 157 for material properties and technical information.

Product Features

- Proven, tested and trusted product in various markets
- Recommended for the safe installation of rigid pipes and tubes
- Available for all commonly used pipe and tube outside diameters
- Environmental protection due to vibration/noise reducing design
- Excellent weathering resistance, even under extreme conditions



Clamp Body - Type H

Smooth Inside Surface without Tension Clearance

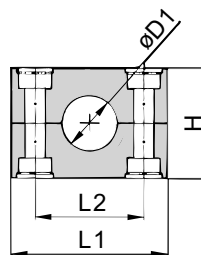
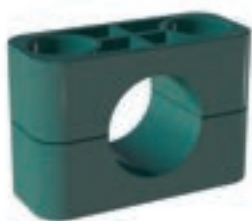

B

Ordering Codes

Clamp Body

***3*006-*PP-H**

One clamp body is consisting of two clamp halves.

- * 1st part of STAUFF Group **3**
- * Exact outside diameter Ø D1 (mm) **006**
- * Material code (see below) **PP-H**

Standard Materials



Polypropylene
Colour: Green
Material code: **PP-H**



Polypropylene
Colour: Green
Material code: **PP-H-BK**



Polyamide
Colour: Black
Material code: **PA-H**



Thermoplastic Elastomer (87 Shore-A)
Colour: Black
Material code: **SA-H**

See pages 154 / 155 for material properties and technical information.

Special Materials

Please contact STAUFF for further details on fire-proof clamp body materials, tested and approved according to several international fire-protection standards (such as BS 6853, EN 45545-2, UL 94 and many more).

See pages 156 / 157 for material properties and technical information.

Product Features

- Proven, tested and trusted product in various markets
- Recommended for the safe installation of hoses and cables
- Chamfered edges avoid damaging of the hose or cable
- Available for all commonly used hose and cable outside diameters
- Excellent weathering resistance, even under extreme conditions

Group	STAUFF	DIN	Outside Diameter		Ordering Codes (2 Clamp Halves) (**H = Material)	Dimensions (^{mm} / _{in})			
			Hose Ø D1 (mm)	(in)		L1	L2	H	Width
3S	1	6			3006-**-H	55 2.16	33 1.30	30,5 1.20	30,5 1.20
		6,4	1/4	3006.4-**-H					
		8	5/16	3008-**-H					
		9,5	3/8	3009.5-**-H					
		10		3010-**-H					
		12		3012-**-H					
		12,7	1/2	3012.7-**-H					
		13,5		3013.5-**-H					
		14		3014-**-H					
		15		3015-**-H					
		16	5/8	3016-**-H					
		17,2		3017.2-**-H					
		18		3018-**-H					
4S	2	19	3/4	4019-**-H	70 2.76	45 1.77	46,5 1.83	30,5 1.20	
		20		4020-**-H					
		21,3		4021.3-**-H					
		22	7/8	4022-**-H					
		25		4025-**-H					
		25,4	1	4025.4-**-H					
		26,9		4026.9-**-H					
		28		4028-**-H					
30		4030-**-H							
5S	3	30		5030-**-H	85 3.35	60 2.36	58 2.28	30,5 1.20	
		32	1-1/4	5032-**-H					
		33,7		5033.7-**-H					
		35		5035-**-H					
		38	1-1/2	5038-**-H					
		40		5040-**-H					
		41,3		5041.3-**-H					
42		5042-**-H							
6S	4	38	1-1/2	6038-**-H	115 4.53	90 3.54	87 3.43	45 1.77	
		42		6042-**-H					
		44,5	1-3/4	6044.5-**-H					
		48,3		6048.3-**-H					
		50,8	2	6050.8-**-H					
		55		6055-**-H					
		57		6057-**-H					
		57,2	2-1/4	6057.2-**-H					
		60,3		6060.3-**-H					
		63,5	2-1/2	6063.5-**-H					
65		6065-**-H							
70	2-3/4	6070-**-H							

Additional outside diameters are available upon request. Please contact STAUFF for further information.



Clamp Body with Elastomer Insert
Type RI

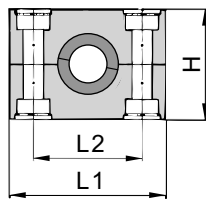
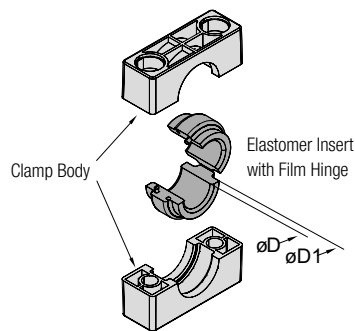

B

Group	STAUFF	DIN	Outside Diameter		Ordering Codes	(**R = Clamp Body Material)	Insert *	Dimensions				
			Pipe / Tube / Hose	Ø D				Clamp Assembly	Clamp Body	(mm/in)	Ø D1	L1
4S	2		6		4006-**-R	4S-**-R	RI-06-4/4S	25	70	45	46,5	30,5
			8	5/16	4008-**-R		RI-08-4/4S					
			10		4010-**-R		RI-10-4/4S					
			12		4012-**-R		RI-12-4/4S					
			12,7	1/2	4012.7-**-R		RI-12.7-4/4S					
			14		4014-**-R		RI-14-4/4S					
			15		4015-**-R		RI-15-4/4S					
			16	5/8	4016-**-R		RI-16-4/4S					
			17,2		4017.2-**-R		RI-17.2-4/4S					
			18		4018-**-R		RI-18-4/4S					
19	3/4	4019-**-R	RI-19-4/4S									
5S	3		20		5020-**-R	5S-**-R	RI-20-6/5S	38	85	60	58	30,5
			21,3		5021.3-**-R		RI-21.3-6/5S					
			22	7/8	5022-**-R		RI-22-6/5S					
			25		5025-**-R		RI-25-6/5S					
			26,9		5026.9-**-R		RI-26.9-6/5S					
			28		5028-**-R		RI-28-6/5S					
			30		5030-**-R		RI-30-6/5S					
			32	1-1/4	5032-**-R		RI-32-6/5S					
			32	1-1/4	6032-**-R		RI-32-6S					
			33,7		6033.7-**-R		RI-33.7-6S					
6S	4		35		6035-**-R	6S-**-R	RI-35-6S	64	115	90	87	45
			38,7		6038.7-**-R		RI-38.7-6S					
			40		6040-**-R		RI-40-6S					
			42		6042-**-R		RI-42-6S					
			45,5		6045.5-**-R		RI-45.5-6S					
			48		6048-**-R		RI-48-6S					
			51	2	6051-**-R		RI-51-6S					
			53,4		6053.4-**-R		RI-53.4-6S					
			56,4		6056.4-**-R		RI-56.4-6S					
			55		7055-**-R		RI-55-7S					
7S	5		57	2-1/4	7057-**-R	7S-**-R	RI-57-7S	88	154	122	120	60
			60		7060-**-R		RI-60-7S					
			63,5	2-1/2	7063.5-**-R		RI-63.5-7S					
			65		7065-**-R		RI-65-7S					
			70	2-3/4	7070-**-R		RI-70-7S					
			72		7072-**-R		RI-72-7S					
			76	3	7076-**-R		RI-76-7S					
			80		8080-**-R		RI-80-8S					
8S	6		88,9	3-1/2	8088.9-**-R	8S-**-R	RI-88.9-8S	114	208	168	168	80
			102		8102-**-R		RI-102-8S					
			114		9114-**-R		RI-114-9S					
9S	7		133	5-1/4	9133-**-R	9S-**-R	RI-133-9S	150	251	205	200	91
			140		9140-**-R		RI-140-9S					
			150		10150-**-R		RI-150-10S					
10S	8		165		10165-**-R	10S-**-R	RI-165-10S	200	336	265	270	120
			168		10168-**-R		RI-168-10S					
			172		10172-**-R		RI-172-10S					

Ordering Codes

Clamp Assembly *4*006-*PP-R

One assembly is consisting of one clamp body and one insert.

* 1st part of STAUFF Group **4**
 * Exact outside diameter Ø D (mm) **006**
 * Material code (see below) **PP-R**

Clamp Body *4S-*PP-R

One clamp body is consisting of two clamp halves.

* STAUFF Group **4S**
 * Material code (see below) **PP-R**

Elastomer Insert *RI-*06-*4/4S

* Elastomer Insert **RI**
 * Exact outside diameter Ø D (mm) **06**
 * STAUFF Group 4S (Heavy) and 4 (Standard) **4/4S**
 5S (Heavy) and 6 (Standard) **6/5S**
 6S (Heavy) **6S**
 7S (Heavy) **7S**
 8S (Heavy) **8S**
 9S (Heavy) **9S**
 10S (Heavy) **10S**

Standard Materials

Polypropylene
 Colour: Black
 Material code: **PP-R**

Polyamide
 Colour: Black
 Material code: **PA-R**

Elastomer Insert
 4S to 6S: **Thermoplastic Elastomer (73 Shore-A)**
 7S to 10S: **EPDM (70 Shore-A)**
 Colour: Black

See pages 154 / 155 for material properties and technical information.

Special Materials

Please contact STAUFF for further details on fire-proof clamp body materials, tested and approved according to several international fire-protection standards (such as BS 6853, EN 45545-2, UL 94 and many more).

See pages 156 / 157 for material properties and technical information.

- Product Features**
- Proven, tested and trusted product in various markets
 - Either for the extra vibration/noise reducing installation of pipes and tubes or the extra gentle installation of hoses and cables
 - Available for all commonly used outside diameters
 - Excellent weathering resistance, even under extreme conditions

* Elastomer Inserts for Heavy Series clamp bodies, STAUFF Group 4S also fit into Standard Series clamp bodies, STAUFF Group 4. Elastomer Inserts for Heavy Series clamp bodies, STAUFF Group 5S also fit into Standard Series clamp bodies, STAUFF Group 6.

Additional outside diameters are available upon request. Please contact STAUFF for further information.

Weld Plate for Single Clamps Type SPAL

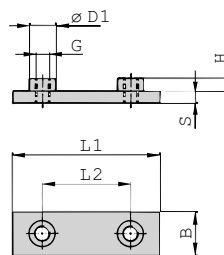

B

Ordering Codes

Weld Plate *SPAL-*3S-*M-*W2

* Weld Plate for Single Clamps		SPAL
* STAUFF Group		3S
* Thread code	Metric ISO thread	M
	Unified coarse (UNC) thread	U
* Material code	Carbon Steel, uncoated	W1
	Carbon Steel, phosphated	W2
	Carbon Steel, zinc/nickel-plated	W3
	Stainless Steel V2A	W4
	1.4301 / 1.4305 (AISI 304 / 303)	
	Stainless Steel V4A	W5
	1.4401 / 1.4571 (AISI 316 / 316 Ti)	

Group	STAUFF	DIN	Dimensions (mm/m)					Thread G	ØD1	Ordering Codes (Standard Options)
			L1	L2	B	S	H			
3S	1		74	33	30	8	8	M10	18	SPAL-3S-M-W2
			2.91	1.30	1.18	.31	.31	3/8-16 UNC	.71	SPAL-3S-U-W2
4S	2		86	45	30	8	8	M10	18	SPAL-4S-M-W2
			3.39	1.77	1.18	.31	.31	3/8-16 UNC	.71	SPAL-4S-U-W2
5S	3		100	60	30	8	8	M10	18	SPAL-5S-M-W2
			3.94	2.36	1.18	.31	.31	3/8-16 UNC	.71	SPAL-5S-U-W2
6S	4		140	90	45	10	8	M12	20	SPAL-6S-M-W2
			5.51	3.54	1.77	.39	.31	7/16-14 UNC	.78	SPAL-6S-U-W2
7S	5		180	122	60	10	12	M16	24	SPAL-7S-M-W2
			7.09	4.80	2.36	.39	.47	5/8-11 UNC	.94	SPAL-7S-U-W2
8S	6		226	168	80	15	18	M20	30	SPAL-8S-M-W1
			8.90	6.61	3.15	.59	.71	3/4-10 UNC	1.18	SPAL-8S-U-W1
9S	7		270	205	90	15	21	M24	35	SPAL-9S-M-W1
			10.63	8.07	3.54	.59	.83	7/8-9 UNC	1.38	SPAL-9S-U-W1
10S	8		340	265	120	25	21	M30	45	SPAL-10S-M-W1
			13.39	10.43	4.72	.98	.83	1-1/8-7 UNC	1.77	SPAL-10S-U-W1
11S	9		520	395	160	30	38	M30	50	SPAL-11S-M-W1
			20.47	15.55	6.30	1.18	1.50	1-1/4-7 UNC	1.97	SPAL-11S-U-W1
12S	10		680	534	180	30	38	M30	50	SPAL-12S-M-W1
			27.16	21.02	7.09	1.18	1.50	1-1/4-7 UNC	1.97	SPAL-12S-U-W1

All threaded parts are available with Metric ISO thread or unified coarse (UNC) thread according to dimension table. Alternative materials and surface finishings are available upon request. Contact STAUFF for further information.

Weld Plate for Double Clamps Type SPAS

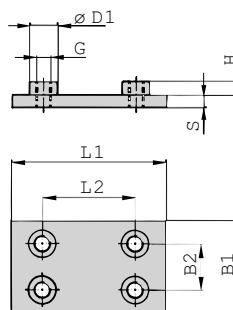

Ordering Codes

Weld Plate *SPAS-*3S-*M-*W2

* Weld Plate for Double Clamps		SPAS
* STAUFF Group		3S
* Thread code	Metric ISO thread	M
	Unified coarse (UNC) thread	U
* Material code	Carbon Steel, uncoated	W1
	Carbon Steel, phosphated	W2
	Carbon Steel, zinc/nickel-plated	W3
	Stainless Steel V2A	W4
	1.4301 / 1.4305 (AISI 304 / 303)	
	Stainless Steel V4A	W5
	1.4401 / 1.4571 (AISI 316 / 316 Ti)	

Group	STAUFF	DIN	Dimensions (mm/m)					Thread G	ØD1	Ordering Codes (Standard Options)	
			L1	L2	B1	B2	S				H
3S	1		74	33	60	30.5	8	8	M10	18	SPAS-3S-M-W2
			2.91	1.30	2.36	1.20	.31	.31	3/8-16 UNC	.71	SPAS-3S-U-W2
4S	2		86	45	60	30.5	8	8	M10	18	SPAS-4S-M-W2
			3.39	1.77	2.36	1.20	.31	.31	3/8-16 UNC	.71	SPAS-4S-U-W2
5S	3		100	60	60	30.5	8	8	M10	18	SPAS-5S-M-W2
			3.94	2.36	2.36	1.20	.31	.31	3/8-16 UNC	.71	SPAS-5S-U-W2
6S	4		140	90	90	46	10	8	M12	20	SPAS-6S-M-W2
			5.51	3.54	3.54	1.81	.39	.31	7/16-14 UNC	.78	SPAS-6S-U-W2
7S	5		180	122	120	61	10	12	M16	24	SPAS-7S-M-W2
			7.09	4.80	4.72	2.40	.39	.47	5/8-11 UNC	.94	SPAS-7S-U-W2
8S	6		226	168	160	81	15	18	M20	30	SPAS-8S-M-W1
			8.90	6.61	6.61	3.19	.59	.71	3/4-10 UNC	1.18	SPAS-8S-U-W1
9S	7		270	205	180	91	15	21	M24	35	SPAS-9S-M-W1
			10.63	8.07	7.09	3.58	.59	.83	7/8-9 UNC	1.38	SPAS-9S-U-W1
10S	8		340	265	240	121	25	21	M30	45	SPAS-10S-M-W1
			13.39	10.43	9.45	4.78	.98	.83	1-1/8-7 UNC	1.77	SPAS-10S-U-W1
11S	9		520	395	324	166	30	38	M30	50	SPAS-11S-M-W1
			20.47	15.55	12.76	6.54	1.18	1.50	1-1/4-7 UNC	1.97	SPAS-11S-U-W1
12S	10		680	534	364	186	30	38	M30	50	SPAS-12S-M-W1
			27.16	21.02	14.33	7.32	1.18	1.50	1-1/4-7 UNC	1.97	SPAS-12S-U-W1

All threaded parts are available with Metric ISO thread or unified coarse (UNC) thread according to dimension table. Alternative materials and surface finishings are available upon request. Contact STAUFF for further information.



Elongated Weld Plate for Single Clamps
Type SPAL-DUEB

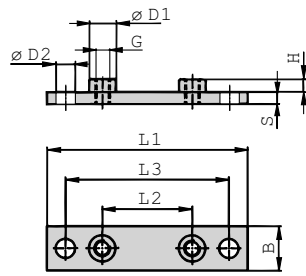

B

Group STAUFF	DIN	Dimensions (mm/m)								Ordering Codes (Standard Options)	
		L1	L2	L3	B	S	H	Thread G	ØD1	ØD2	
3S	1	113	33	85	30	8	8	M10	18	13	SPAL-DUEB-3S-M-W2
		4.45	1.30	3.35	1.18	.31	.31	3/8-16 UNC	.71	.51	SPAL-DUEB-3S-U-W2
4S	2	125	45	97	30	8	8	M10	18	13	SPAL-DUEB-4S-M-W2
		4.92	1.77	3.82	1.18	.31	.31	3/8-16 UNC	.71	.51	SPAL-DUEB-4S-U-W2
5S	3	140	60	112	30	8	8	M10	18	13	SPAL-DUEB-5S-M-W2
		5.51	2.36	4.41	1.18	.31	.31	3/8-16 UNC	.71	.51	SPAL-DUEB-5S-U-W2
6S	4	187	90	155	45	10	8	M12	20	16	SPAL-DUEB-6S-M-W2
		7.36	3.54	6.10	1.77	.39	.12	7/16-14 UNC	.78	.62	SPAL-DUEB-6S-U-W2
7S	5	238	122	198	60	10	12	M16	24	21	SPAL-DUEB-7S-M-W2
		9.37	4.80	7.80	2.36	.39	.47	5/8-11 UNC	.94	.83	SPAL-DUEB-7S-U-W2
8S	6	309	168	259	80	15	18	M20	30	26	SPAL-DUEB-8S-M-W1
		12.17	6.61	10.20	3.15	.59	.71	3/4-10 UNC	1.18	1.02	SPAL-DUEB-8S-U-W1
9S	7	370	205	310	90	15	21	M24	35	31	SPAL-DUEB-9S-M-W1
		14.57	8.07	12.20	3.54	.59	.83	7/8-9 UNC	1.38	1.22	SPAL-DUEB-9S-U-W1
10S	8	460	265	400	120	25	21	M30	45	31	SPAL-DUEB-10S-M-W1
		18.11	10.43	15.75	4.72	.98	.83	1-1/8-7 UNC	1.77	1.22	SPAL-DUEB-10S-U-W1
11S	9	590	395	530	160	30	38	M30	50	31	SPAL-DUEB-11S-M-W1
		23.23	15.55	20.87	6.30	1.18	1.50	1-1/4-7 UNC	1.97	1.22	SPAL-DUEB-11S-U-W1
12S	10	750	534	690	180	30	38	M30	50	31	SPAL-DUEB-12S-M-W1
		29.53	21.02	27.17	7.09	1.18	1.50	1-1/4-7 UNC	1.97	1.22	SPAL-DUEB-12S-U-W1

Ordering Codes

Weld Plate *SPAL-DUEB-*3S-*M-*W2

- * Elongated Weld Plate for Single Clamps **SPAL-DUEB**
- * STAUFF Group **3S**
- * Thread code Metric ISO thread **M**
Unified coarse (UNC) thread **U**
- * Material code Carbon Steel, uncoated **W1**
Carbon Steel, phosphated **W2**
Carbon Steel, zinc/nickel-plated **W3**
Stainless Steel V2A **W4**
1.4301 / 1.4305 (AISI 304 / 303)
Stainless Steel V4A **W5**
1.4401 / 1.4571 (AISI 316 / 316 Ti)

All threaded parts are available with Metric ISO thread or unified coarse (UNC) thread according to dimension table. Alternative materials and surface finishings are available upon request. Contact STAUFF for further information.

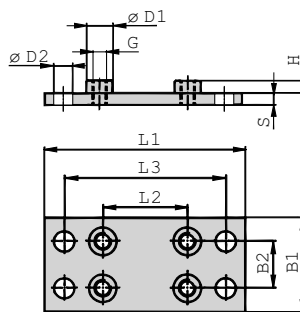
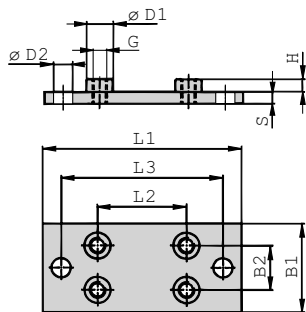

Elongated Weld Plate for Double Clamps
Type SPAS-DUEB



Design for STAUFF Group 10S to 12S

STAUFF Group 3S to 9S

STAUFF Group 10S to 12S

Group STAUFF	DIN	Dimensions (mm/m)								Ordering Codes (Standard Options)		
		L1	L2	L3	B1	B2	S	H	Thread G	ØD1	ØD2	
3S	1	113	33	85	60	30.5	8	8	M10	18	13	SPAS-DUEB-3S-M-W2
		4.45	1.30	3.35	2.36	1.20	.31	.31	3/8-16 UNC	.71	.51	SPAS-DUEB-3S-U-W2
4S	2	125	45	97	60	30.5	8	8	M10	18	13	SPAS-DUEB-4S-M-W2
		4.92	1.77	3.82	2.36	1.20	.31	.31	3/8-16 UNC	.71	.51	SPAS-DUEB-4S-U-W2
5S	3	140	60	112	60	30.5	8	8	M10	18	13	SPAS-DUEB-5S-M-W2
		5.51	2.36	4.41	2.36	1.20	.31	.31	3/8-16 UNC	.71	.51	SPAS-DUEB-5S-U-W2
6S	4	187	90	155	90	46	10	8	M12	20	16	SPAS-DUEB-6S-M-W2
		7.36	3.54	6.10	3.54	1.81	.39	.31	7/16-14 UNC	.78	.62	SPAS-DUEB-6S-U-W2
7S	5	238	122	198	120	61	10	12	M16	24	21	SPAS-DUEB-7S-M-W2
		9.37	4.80	7.80	4.72	2.40	.39	.47	5/8-11 UNC	.94	.83	SPAS-DUEB-7S-U-W2
8S	6	309	168	259	160	81	15	18	M20	30	26	SPAS-DUEB-8S-M-W1
		12.17	6.61	10.20	6.61	3.19	.59	.71	3/4-10 UNC	1.18	1.02	SPAS-DUEB-8S-U-W1
9S	7	370	205	310	180	91	15	21	M24	35	31	SPAS-DUEB-9S-M-W1
		14.57	8.07	12.20	7.09	3.58	.59	.83	7/8-9 UNC	1.38	1.22	SPAS-DUEB-9S-U-W1
10S	8	460	265	400	240	121	25	21	M30	45	31	SPAS-DUEB-10S-M-W1
		18.11	10.43	15.75	9.45	4.78	.98	.83	1-1/8-7 UNC	1.77	1.22	SPAS-DUEB-10S-U-W1
11S	9	590	395	530	324	166	30	38	M30	50	31	SPAS-DUEB-11S-M-W1
		23.23	15.55	20.87	12.76	6.54	1.18	1.50	1-1/4-7 UNC	1.97	1.22	SPAS-DUEB-11S-U-W1
12S	10	750	534	690	364	186	30	38	M30	50	31	SPAS-DUEB-12S-M-W1
		29.53	21.02	27.17	14.33	7.32	1.18	1.50	1-1/4-7 UNC	1.97	1.22	SPAS-DUEB-12S-U-W1

Ordering Codes

Weld Plate *SPAS-DUEB-*3S-*M-*W2

- * Elongated Weld Plate for Double Clamps **SPAS-DUEB**
- * STAUFF Group **3S**
- * Thread code Metric ISO thread **M**
Unified coarse (UNC) thread **U**
- * Material code Carbon Steel, uncoated **W1**
Carbon Steel, phosphated **W2**
Carbon Steel, zinc/nickel-plated **W3**
Stainless Steel V2A **W4**
1.4301 / 1.4305 (AISI 304 / 303)
Stainless Steel V4A **W5**
1.4401 / 1.4571 (AISI 316 / 316 Ti)

All threaded parts are available with Metric ISO thread or unified coarse (UNC) thread according to dimension table. Alternative materials and surface finishings are available upon request. Contact STAUFF for further information.



Mounting Rail Nut
(for Use with Mounting Rail STSV)
Type GMV

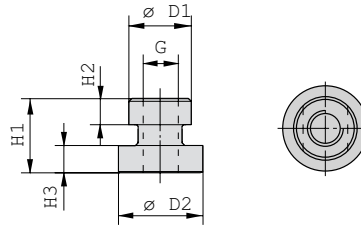

B

Ordering Codes

Mounting Rail Nut *GMV-*3-5S*M-*W3

- * Mounting Rail Nut **GMV**
- * STAUFF Group 3S to 5S (DIN Group 1 to 3) **3-5S**
6S (DIN Group 4) **6S**
- * Thread code Metric ISO thread **M**
Unified coarse (UNC) thread **U**
- * Material code Carbon Steel, zinc/nickel-plated **W3**
Stainless Steel V2A **W4**
1.4301 / 1.4305 (AISI 304 / 303)
Stainless Steel V4A **W5**
1.4401 / 1.4571 (AISI 316 / 316 Ti)

Group STAUFF	DIN	Dimensions (mm/m)					Thread G	Ordering Codes (Standard Options)
		ØD1	ØD2	H1	H2	H3		
3S	1							
4S	2	17,8 .70	24 .94	21 .83	7,6 .30	7,4 .29	M10 3/8-16 UNC	GMV-3-5S-M-W3 GMV-3-5S-U-W3
5S	3							
6S	4	19,8 .78	24 .94	23 .91	8,8 .35	8,8 .35	M12 7/16-14 UNC	GMV-6S-M-W3 GMV-6S-U-W3

All threaded parts are available with Metric ISO thread or unified coarse (UNC) thread according to dimension table. Alternative materials and surface finishings are available upon request. Contact STAUFF for further information.

Mounting Rail
(for Use with Mounting Rail Nut GMV)
Type STSV

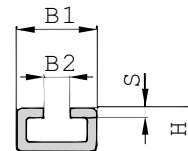

Ordering Codes

Mounting Rail *STSV-*1M-*W1

- * Mounting Rail **STSV**
- * Length of rail 1 m / 3.28 ft **1M**
2 m / 6.56 ft **2M**
Alternative lengths available upon request. Contact STAUFF for further information.
- * Material code Carbon Steel, uncoated **W1**
Carbon Steel, zinc-plated, blue-chromated **W32**
Stainless Steel V4A **W5**
1.4401 / 1.4571 (AISI 316 / 316 Ti)

Group STAUFF	DIN	Dimensions (mm/m)				Ordering Codes (Standard Options)	
		B1	B2	H	S	Length of Rail: 1 m / 3.28 ft	Length of Rail: 2 m / 6.56 ft
3S	1						
4S	2	40	13	22	5	STSV -1M-W1	STSV -2M-W1
5S	3	1.57	.51	.86	.19		
6S	4						

Alternative materials and surface finishings are available upon request. Contact STAUFF for further information.



Channel Rail Adaptor
(for Use with Various Channel Rails)
Type CRA

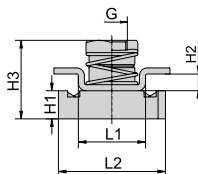
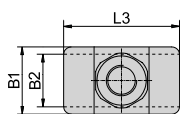

B

Group STAUFF	DIN	Dimensions (mm/m)									Ordering Codes (Standard Options)		
		Thread G	L1	L2	L3	B1	B2	H1	H2	H3			
3S	1												
4S	2	M10	22	35	38	22	20,5	9,2	5,5	27,5	CRA-3-5S-M-W3		
		3/8-16 UNC	.87	1.38	1.50	.87	.81	.36	.22	1.08	CRA-3-5S-U-W3		
5S	3												
6S	4	M12	21,5	35	45	25	19	9,2	5	27,5	CRA-6S-M-W3		
		7/16-14 UNC	.85	1.38	1.77	.98	.75	.36	.20	1.08	CRA-6S-U-W3		

Ordering Codes

Adaptor ***CRA-*3-5S-*M-*W3**

- * Channel Rail Adaptor **CRA**
- * STAUFF Group 3S to 5S (DIN Group 1 to 3) **3-5S**
6S (DIN Group 4) **6S**
- * Thread code Metric ISO thread **M**
Unified coarse (UNC) thread **U**
- * Material code Carbon Steel, zinc/nickel-plated **W3**
Stainless Steel V4A **W5**
1.4401 / 1.4571 (AISI 316 / 316 Ti)

All threaded parts are available with Metric ISO thread or unified coarse (UNC) thread according to dimension table. Alternative materials and surface finishings are available upon request. Contact STAUFF for further information.

Compatibility with Channel Rails

The STAUFF Channel Rail Adaptor, type CRA is suitable for various channel rails, including the following types:

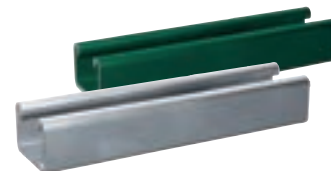

HALFEN	HILTI	UNISTRUT®	STAUFF (Cushion Clamp Series)
HM 41/41	MQ-21, MQ-41, MQ-52, MQ-72	P1000, P1000T, P1000V, P1000VT, P1001	SCS-048-1-PL, SCS-048-1-GR
HZA 41/22	MQ-21U, MQ-41U, MQ-72U	P2000, P2000T	SCS-120-1-PL, SCS-120-1-GR
HZM 41/41	MQ-21D, MQ-41D, MQ-52-72D	P3003, P3003T, P3300V, P3300VT, P3301	See page 149 for technical information.
HZM 41/22		P4000, P4000T	
HL 41/41, HL 41/B2		P5000, P5000T, P5001, P5500, P5500T, P5501	

Contact STAUFF to check compatibility with additional types of channel rails.

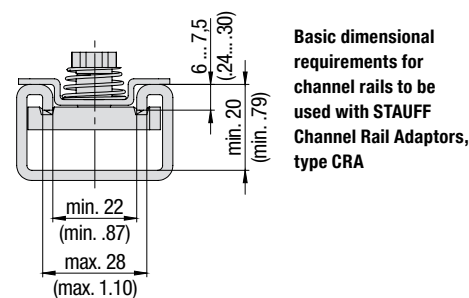

Recommended Bolt Lengths when using the Channel Rail Adaptor, Type CRA

Group STAUFF	DIN	Hexagon Head Bolts AS (used with Cover Plates DPAL or DPAS)		Socket Cap Screws IS (used without Cover Plates DPAL or DPAS)	
		Metric ISO thread	Unified coarse (UNC) thread	Metric ISO thread	Unified coarse (UNC) thread
3S	1	M10 x 40	3/8-16 UNC x 1-1/2	M10 x 25	3/8-16 UNC x 1
4S	2	M10 x 55	3/8-16 UNC x 2-1/4	M10 x 40	3/8-16 UNC x 1-1/2
5S	3	M10 x 65	3/8-16 UNC x 2-3/4	M10 x 50	3/8-16 UNC x 2
6S	4	M12 x 100	7/16-14 UNC x 3-3/4	M12 x 75	7/16-14 UNC x 3

Clamp assemblies including Channel Rail Adaptors, type CRA are supplied with the recommended bolt lengths by default. See page 48 for further information on ordering.



Cover Plate for Single Clamps Type DPAL

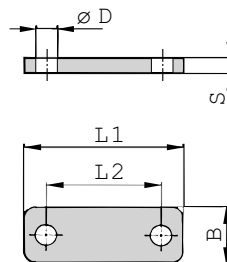

B

Ordering Codes

Cover Plate

***DPAL-*3S-*W2**

* Cover Plate for Single Clamps	DPAL
* STAUFF Group	3S
* Material code	W1
Carbon Steel, uncoated	W2
Carbon Steel, phosphated	W3
Carbon Steel, zinc/nickel-plated	W4
Stainless Steel V2A	W5
1.4301 / 1.4305 (AISI 304 / 303)	W5
Stainless Steel V4A	W5
1.4401 / 1.4571 (AISI 316 / 316 Ti)	W85
Aluminium EN AW-6060	W85
(for group sizes 3S to 5S only)	

Group STAUFF	DIN	Dimensions (mm/m)					Ordering Codes (Standard Options)
		L1	L2	B	S	ØD	
3S	1	55	33	30	8	11	DPAL-3S-W2
		2.16	1.30	1.18	.31	.43	
4S	2	70	45	30	8	11	DPAL-4S-W2
		2.76	1.77	1.18	.31	.43	
5S	3	85	60	30	8	11	DPAL-5S-W2
		3.35	2.36	1.18	.31	.43	
6S	4	115	90	45	10	14	DPAL-6S-W2
		4.53	3.54	1.77	.39	.55	
7S	5	152	122	60	10	19	DPAL-7S-W2
		5.98	4.80	2.36	.39	.75	
8S	6	206	168	80	15	22	DPAL-8S-W1
		8.11	6.61	3.15	.59	.87	
9S	7	251	205	90	15	26	DPAL-9S-W1
		9.88	8.07	3.54	.59	1.02	
10S	8	320	265	120	25	35	DPAL-10S-W1
		12.60	10.43	4.72	.98	1.38	
11S	9	470	395	160	30	35	DPAL-11S-W1
		18.50	15.55	6.30	1.18	1.38	
12S	10	630	534	180	30	35	DPAL-12S-W1
		24.80	21.02	7.09	1.18	1.38	

Alternative materials and surface finishings are available upon request. Contact STAUFF for further information.

Cover Plate for Double Clamps Type DPAS

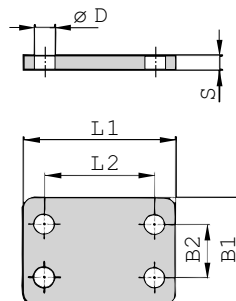

Ordering Codes

Cover Plate

***DPAS-*3S-*W2**

* Cover Plate for Double Clamps	DPAS
* STAUFF Group	3S
* Material code	W1
Carbon Steel, uncoated	W2
Carbon Steel, phosphated	W3
Carbon Steel, zinc/nickel-plated	W4
Stainless Steel V2A	W5
1.4301 / 1.4305 (AISI 304 / 303)	W5
Stainless Steel V4A	W5
1.4401 / 1.4571 (AISI 316 / 316 Ti)	

Group STAUFF	DIN	Dimensions (mm/m)					Ordering Codes (Standard Options)	
		L1	L2	B1	B2	S		ØD
3S	1	55	33	60	30,5	8	11	DPAS-3S-W2
		2.16	1.30	2.36	1.20	.31	.43	
4S	2	70	45	60	30,5	8	11	DPAS-4S-W2
		2.76	1.77	2.36	1.20	.31	.43	
5S	3	83	60	60	30,5	8	11	DPAS-5S-W2
		3.27	2.36	2.36	1.20	.31	.43	
6S	4	115	90	90	46	10	14	DPAS-6S-W2
		4.53	3.54	3.54	1.81	.39	.55	
7S	5	152	122	120	61	10	19	DPAS-7S-W2
		5.98	4.80	4.72	2.40	.39	.75	
8S	6	206	168	160	81	15	22	DPAS-8S-W1
		8.11	6.61	6.61	3.19	.59	.87	
9S	7	251	205	180	91	15	26	DPAS-9S-W1
		9.88	8.07	7.09	3.58	.59	1.02	
10S	8	320	265	240	121	25	35	DPAS-10S-W1
		12.60	10.43	9.45	4.78	.98	1.38	
11S	9	470	395	321	166	30	35	DPAS-11S-W1
		18.50	15.55	12.64	6.54	1.18	1.38	
12S	10	630	534	361	186	30	35	DPAS-12S-W1
		24.80	21.02	14.21	7.32	1.18	1.38	

Alternative materials and surface finishings are available upon request. Contact STAUFF for further information.



Hexagon Head Bolt Type AS

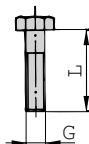

B

Hexagon Head Bolt AS

(according to DIN 931 / 933 or ANSI / ASME B18.2.1.)

Dimensions applicable only when used with Cover Plates DPAL or DPAS

Group STAUFF	DIN	Dimensions (mm/in) Thread G x L	Ordering Codes (Standard Options)
3S	1	M10 x 45	AS-M10x45-W1
		3/8-16 UNC x 1-3/4	AS-3/8-16UNCx1-3/4-W3*
4S	2	M10 x 60	AS-M10x60-W1
		3/8-16 UNC x 2-1/4	AS-3/8-16UNCx2-1/4-W3*
5S	3	M10 x 70	AS-M10x70-W1
		3/8-16 UNC x 2-3/4	AS-3/8-16UNCx2-3/4-W3*
6S	4	M12 x 100	AS-M12x100-W1
		7/16-14 UNC x 4	AS-7/16-14UNCx4-W3*
7S	5	M16 x 130	AS-M16x130-W1
		5/8-11 UNC x 5-1/4	AS-5/8-11UNCx5-1/4-W3*
8S	6	M20 x 190	AS-M20x190-W1
		3/4-10 UNC x 7-1/2	AS-3/4-10UNCx7-1/2-W1
9S	7	M24 x 220	AS-M24x220-W1
		7/8-9 UNC x 8-3/4	AS-7/8-9UNCx8-3/4-W1
10S	8	M30 x 300	AS-M30x300-W1
		1-1/8-7 UNC x 12	AS-1-1/8-7UNCx12-W1
11S	9	M30 x 450	AS-M30x450-W1
		1-1/4-7 UNC x 17-1/2	AS-1-1/4-7UNCx17-1/2-W1
12S	10	M30 x 560	AS-M30x560-W1
		1-1/4-7 UNC x 22	AS-1-1/4-7UNCx22-W1

Ordering Codes

Hexagon Head Bolt *AS-*M10x70-*W1

* Type of bolt	Hexagon Head Bolt (according to DIN 931 / 933 or ANSI / ASME B18.2.1.)	AS
* Thread type and size acc. to dimension table		M10x70
* Material code	Carbon Steel, uncoated	W1
	Carbon Steel, zinc/nickel-plated	W3
	Stainless Steel V2A 1.4301 / 1.4305 (AISI 304 / 303)	W4
	Stainless Steel V4A 1.4401 / 1.4571 (AISI 316 / 316 Ti)	W5

* Standard finishing option for Heavy Series group sizes 3S to 7S in North America is W3 (Carbon Steel, zinc/nickel-plated).

All threaded parts are available with Metric ISO thread or unified coarse (UNC) thread according to dimension table. Alternative materials and surface finishings are available upon request. Contact STAUFF for further information.

Socket Cap Screw Type IS

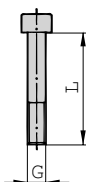

Socket Cap Screw IS

(according to ISO 4762 or ANSI / ASME B18.3)

Dimensions applicable only when used without Cover Plates

Group STAUFF	DIN	Dimensions (mm/in) Thread G x L	Ordering Codes (Standard Options)
3S	1	M10 x 30	IS-M10x30-W1
		3/8-16 UNC x 1	IS-3/8-16UNCx1-W3*
4S	2	M10 x 40	IS-M10x40-W1
		3/8-16 UNC x 1-3/4	IS-3/8-16UNCx1-3/4-W3*
5S	3	M10 x 50	IS-M10x50-W1
		3/8-16 UNC x 2	IS-3/8-16UNCx2-W3*
6S	4	M12 x 80	ISM12x80-W1
		7/16-14 UNC x 3-1/4	IS-7/16-14UNCx3-1/4-W3*

Ordering Codes

Socket Cap Screw *IS-*M10x50-*W1

* Type of Bolt	Socket Cap Screw (according to ISO 4762 or ANSI / ASME B18.3)	IS
* Thread type and size acc. to dimension table		M10x50
* Material code	Carbon Steel, uncoated	W1
	Carbon Steel, zinc/nickel-plated	W3
	Stainless Steel V2A 1.4301 / 1.4305 (AISI 304 / 303)	W4
	Stainless Steel V4A 1.4401 / 1.4571 (AISI 316 / 316 Ti)	W5

All threaded parts are available with Metric ISO thread or unified coarse (UNC) thread according to dimension table. Alternative materials and surface finishings are available upon request. Contact STAUFF for further information.

* Standard finishing option in North America is W3 (Carbon Steel, zinc/nickel-plated).



Safety Washer

(for Use with Hexagon Head Bolt AS)

Type SI (DIN 93)

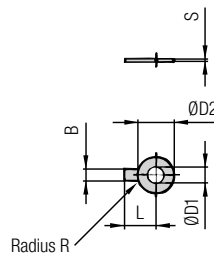

Safety Washer SI

(Bend longer tab down towards the side of the clamp body and one side up towards one of the flats of the hexagon head bolt)

Ordering Codes

Safety Washer *SI-*10.5-*DIN93-*W3

- * Safety Washer **SI**
- * Exact inner diameter ØD1 (mm) **10.5**
- * Type of washer Safety washer with 1 tab (according to DIN 93) **DIN 93**
- * Material code Carbon Steel, zinc/nickel-plated **W3**
- Stainless Steel V4A **W5**
- 1.4401 / 1.4571 (AISI 316 / 316 Ti)

Group STAUFF	DIN	Dimensions (mm / in)						Ordering Codes (Standard Options)
		ØD1	B	ØD2	L	R	S	
3S	1	10,5	10	26	22	4	0,75	SI-10.5-DIN93-W3
		.41	.39	1.02	.87	.16	.03	
4S	2	10,5	10	26	22	4	0,75	SI-10.5-DIN93-W3
		.41	.39	1.02	.87	.16	.03	
5S	3	10,5	10	26	22	4	0,75	SI-10.5-DIN93-W3
		.41	.39	1.02	.87	.16	.03	
6S	4	13	12	30	28	6	1	SI-13-DIN93-W3
		.51	.47	1.18	1.10	.24	.04	
7S	5	17	15	36	32	6	1	SI-17-DIN93-W3
		.67	.59	1.42	1.26	.24	.04	
8S	6	21	18	42	36	6	1	SI-21-DIN93-W3
		.83	.71	1.65	1.42	.24	.04	
9S	7	25	20	50	42	6	1	SI-25-DIN93-W3
		.98	.79	1.97	1.65	.24	.04	
10S	8	31	26	63	52	10	1,6	SI-31-DIN93-W3
		1.22	1.02	2.48	2.05	.39	.06	
11S	9	31	26	63	52	10	1,6	SI-31-DIN93-W3
		1.22	1.02	2.48	2.05	.39	.06	
12S	10	31	26	63	52	10	1,6	SI-31-DIN93-W3
		1.22	1.02	2.48	2.05	.39	.06	

Safety Washers, type SI are used as locking devices to prevent Hexagon Head Bolts, type AS from loosening. Alternative materials and surface finishings are available upon request. Contact STAUFF for further information.

Safety Washer

(for Use with Hexagon Head Bolt AS)

Type SI (DIN 463)

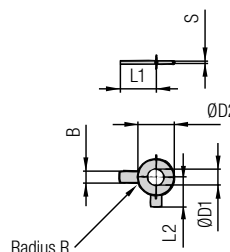

Safety Washer SI

(Bend longer tab down towards the side of the clamp body and shorter tab up towards one of the flats of the hexagon head bolt)

Ordering Codes

Safety Washer *SI-*10.5-*DIN463-*W3

- * Safety Washer **SI**
- * Exact inner diameter ØD1 (mm) **10.5**
- * Type of washer Safety washer with 2 tabs (according to DIN 463) **DIN 463**
- * Material code Carbon Steel, zinc/nickel-plated **W3**
- Stainless Steel V4A **W5**
- 1.4401 / 1.4571 (AISI 316 / 316 Ti)

Group STAUFF	DIN	Dimensions (mm / in)						Ordering Codes (Standard Options)	
		ØD1	B	ØD2	L1	L2	R		S
3S	1	10,5	10	21	22	13	4	0,75	SI-10.5-DIN463-W3
		.41	.39	.83	.87	.51	.16	.03	
4S	2	10,5	10	21	22	13	4	1	SI-10.5-DIN463-W3
		.41	.39	.83	.87	.51	.16	.04	
5S	3	10,5	10	21	22	13	4	1	SI-10.5-DIN463-W3
		.41	.39	.83	.87	.51	.16	.04	
6S	4	13	12	24	28	15	6	1	SI-13-DIN463-W3
		.51	.47	.94	1.10	.59	.24	.04	
7S	5	17	15	30	32	18	6	1	SI-17-DIN463-W3
		.67	.59	1.18	1.26	.71	.24	.04	
8S	6	21	18	37	36	21	6	1	SI-21-DIN463-W3
		.83	.71	1.46	1.42	.83	.24	.04	
9S	7	25	20	44	42	25	6	1	SI-25-DIN463-W3
		.98	.79	1.73	1.65	.98	.24	.04	
10S	8	31	26	56	52	32	10	1,6	SI-31-DIN463-W3
		1.22	1.02	2.20	2.05	1.26	.39	.06	
11S	9	31	26	56	52	32	10	1,6	SI-31-DIN463-W3
		1.22	1.02	2.20	2.05	1.26	.39	.06	
12S	10	31	26	56	52	32	10	1,6	SI-31-DIN463-W3
		1.22	1.02	2.20	2.05	1.26	.39	.06	

Safety Washers, type SI are used as locking devices to prevent Hexagon Head Bolts, type AS from loosening. Alternative materials and surface finishings are available upon request. Contact STAUFF for further information.



Safety Locking Plate
(for Use with Stacking Bolt AF)
Type SIP

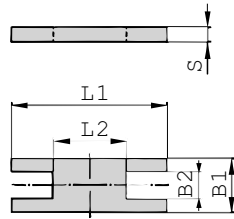

B

Group STAUFF	DIN	Dimensions (mm/in)					Ordering Codes (Standard Options)
		L1	L2	B1	B2	S	
3S	1	57	13	30	15,2	8	SIP-3S-W2
		2.24	.51	1.18	.60	.31	
4S	2	70	26	30	15,2	8	SIP-4S-W2
		2.76	1.02	1.18	.60	.31	
5S	3	85	40	30	15,2	8	SIP-5S-W2
		3.35	1.57	1.18	.60	.31	
6S	4	116	68	45	17,2	10	SIP-6S-W2
		4.57	2.68	1.77	.68	.39	
7S	5	153	96	60	22	10	SIP-7S-W2
		6.02	3.78	2.36	.87	.39	
8S	6	206	130	80	28	15	SIP-8S-W1
		8.11	5.12	3.15	1.10	.59	
9S	7	251	166	90	31	15	SIP-9S-W1
		9.88	6.54	3.54	1.22	.59	
10S	8	317	205	120	49	25	SIP-10-S-W1
		12.48	8.07	4.72	1.93	.98	

Ordering Codes

Safety Locking Plate *SIP-*3S-*W2

* Safety Locking Plate		SIP
* STAUFF Group		3S
* Material code	Carbon Steel, uncoated	W1
	Carbon Steel, phosphated	W2
	Carbon Steel, zinc/nickel-plated	W3
	Stainless Steel V2A	W4
	1.4301 / 1.4305 (AISI 304 / 303)	
	Stainless Steel V4A	W5
	1.4401 / 1.4571 (AISI 316 / 316 Ti)	

Alternative materials and surface finishings are available upon request. Contact STAUFF for further information.

Stacking Bolt
(for Use with Safety Locking Plate SIP)
Type AF

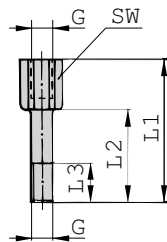

Group STAUFF	DIN	Dimensions (mm/in)					Ordering Codes (Standard Options)
		L1	L2	L3 min.	Hex	Thread G	
3S	1	49	25	15	15	M10	AF-3S-M-W2
		1.93	.98	.59	.59	3/8-16 UNC	AF-3S-U-W3*
4S	2	65	40	15	15	M10	AF-4S-M-W2
		2.56	1.57	.59	.59	3/8-16 UNC	AF-4S-U-W3*
5S	3	77	51	15	15	M10	AF-5S-M-W2
		3.03	2.01	.59	.59	3/8-16 UNC	AF-5S-U-W3*
6S	4	110	82	18	17	M12	AF-6S-M-W2
		4.33	3.23	.71	.67	7/16-14 UNC	AF-6S-U-W3*
7S	5	144	110	24	22	M16	AF-7S-M-W2
		5.67	4.33	.94	.87	5/8-11 UNC	AF-7S-U-W3*
8S	6	200	150	30	27	M20	AF-8S-M-W2
		7.87	5.91	1.18	1.06	3/4-10 UNC	AF-8S-U-W1*
9S	7	240	180	50	30	M24	AF-9S-M-W2
		9.45	7.09	1.97	1.18	7/8-9 UNC	AF-9S-U-W1*
10S	8	331	256	62	46	M30	AF-10S-M-W2
		13.03	10.08	2.44	1.81	1-1/8-7 UNC	AF-10S-U-W1*

Ordering Codes

Stacking Bolt *AF-*3S-*M-*W2

* Stacking Bolt		AF
* STAUFF Group		3S
* Thread code	Metric ISO thread	M
	Unified coarse (UNC) thread	U
* Material code	Carbon Steel, uncoated	W1
	Carbon Steel, phosphated	W2
	Carbon Steel, zinc/nickel-plated	W3
	Stainless Steel V2A	W4
	1.4301 / 1.4305 (AISI 304 / 303)	
	Stainless Steel V4A	W5
	1.4401 / 1.4571 (AISI 316 / 316 Ti)	

All threaded parts are available with Metric ISO thread or unified coarse (UNC) thread according to dimension table. Alternative materials and surface finishings are available upon request. Contact STAUFF for further information.

* Standard finishing option for Heavy Series group sizes 3S to 7S in North America is W3 (Carbon Steel, zinc/nickel-plated). Standard finishing option for Heavy Series group sizes 8S to 10S in North America is W1 (Carbon Steel, uncoated).





B

① Type of Installation

Please select the type of installation (e.g. Weld Plates, Rail Nuts etc.) and add the corresponding Code to position ① of the order code for your clamp assembly.

Without Installation Equipment
Code: **none**

Installation on Weld Plate

Weld Plate for Single Clamps
Code: **SPAL**

Weld Plate for Double Clamps
Code: **SPAS**

Elongated Weld Plate for Single Clamps
Code: **SPAL-DUEB**

Elongated Weld Plate for Double Clamps
Code: **SPAS-DUEB**

Installation on Mounting / Channel Rail

Mounting Rail Nut
Code: **GMV** (for STAUFF Group 3S to 6S only)

Channel Rail Adaptor
Code: **CRA** (for STAUFF Group 3S to 6S only)

② Group Size & Diameter

Please select the required group size and diameter and add the corresponding Code to position ② of the order code for your clamp assembly.

Group STAUFF (DIN)	Outside Diameter P / T / H (mm)	Availability of Clamp Body Materials & Designs			Code
		Profiled Design	Type H	Type RI	
3S (1)	6	●	●	○	3006
	6,4	●	●	○	3006.4
	8	●	●	○	3008
	9,5	●	●	○	3009.5
	10	●	●	○	3010
	12	●	●	○	3012
	12,7	●	●	○	3012.7
	13,5	●	●	○	3013.5
	14	●	●	○	3014
	15	●	●	○	3015
	16	●	●	○	3016
	17,2	●	●	○	3017.2
	18	●	●	○	3018
20	●	○	○	3020	

② Group Size & Diameter CONTINUATION

Group STAUFF (DIN)	Outside Diameter P / T / H (mm)	Availability of Clamp Body Materials & Designs			Code
		Profiled Design	Type H	Type RI	
4S (2)	6	○	○	●	4006
	8	○	○	●	4008
	10	○	○	●	4010
	12	○	○	●	4012
	12,7	○	○	●	4012.7
	14	○	○	●	4014
	15	○	○	●	4015
	16	○	○	●	4016
	17,2	○	○	●	4017.2
	18	○	○	●	4018
	19	●	●	●	4019
	20	●	●	○	4020
	21,3	●	●	○	4021.3
	22	●	●	○	4022
	25	●	●	○	4025
	25,4	●	●	○	4025.4
	26,9	●	●	○	4026.9
28	●	●	○	4028	
30	●	●	○	4030	
5S (3)	20	○	○	●	5020
	21,3	○	○	●	5021.3
	22	○	○	●	5022
	25	○	○	●	5025
	26,9	○	○	●	5026.9
	28	○	○	●	5028
	30	●	●	●	5030
	32	●	●	●	5032
	33,7	●	●	○	5033.7
	35	●	●	○	5035
	38	●	●	○	5038
40	●	●	○	5040	
41,3	●	●	○	5041.3	
42	●	●	○	5042	
6S (4)	32	○	○	●	6032
	33,7	○	○	●	6033.7
	35	○	○	●	6035
	38	●	●	○	6038
	38,7	○	○	●	6038.7
	40	○	○	●	6040
	42	●	●	●	6042
	44,5	●	●	○	6044.5
	45,5	○	○	●	6045.5
	48	○	○	●	6048
	48,3	●	●	○	6048.3
	50,8	●	●	○	6050.8
	51	○	○	●	6051
	53,4	○	○	●	6053.4
54	●	○	○	6054	

② Group Size & Diameter CONTINUATION

Group STAUFF (DIN)	Outside Diameter P / T / H (mm)	Availability of Clamp Body Materials & Designs			Code	
		Profiled Design	Type H	Type RI		
6S (4)	55	●	●	○	6055	
	56,4	○	○	●	6056.4	
	57	●	●	○	6057	
	57,2	●	●	○	6057.2	
	60,3	●	●	○	6060.3	
	63,5	●	●	○	6063.5	
	65	●	●	○	6065	
	70	●	●	○	6070	
	7S (5)	55	○	○	●	7055
		57	○	○	●	7057
60		○	○	●	7060	
60,3		●	○	○	7060.3	
63,5		○	○	●	7063.5	
65		●	○	●	7065	
70		●	○	●	7070	
72		○	○	●	7072	
73		●	○	○	7073	
75		●	○	○	7075	
76		○	○	●	7076	
8S (6)	76,1	●	○	○	7076.1	
	80	●	○	○	7080	
	82,5	●	○	○	7082.5	
	88,9	●	○	○	7088.9	
	80	○	○	●	8080	
	88,9	●	○	●	8088.9	
	100	●	○	○	8100	
	102	●	○	●	8102	
	108	●	○	○	8108	
	114	●	○	○	8114	
	127	●	○	○	8127	
133	●	○	○	8133		
9S (7)	114	○	○	●	9114	
	127	●	○	○	9127	
	133	●	○	●	9133	
	140	●	○	●	9140	
	152	●	○	○	9152	
	159	●	○	○	9159	
	165	●	○	○	9165	
168	●	○	○	9168		
10S (8)	150	○	○	●	10150	
	165	○	○	●	10165	
	168	●	○	●	10168	
	172	○	○	●	10172	
	177,8	●	○	○	10177.8	
	193,7	●	○	○	10193.7	
	203	●	○	○	10203	
	216	●	○	○	10216	
	219	●	○	○	10219	
	219	●	○	○	11219	
11S (9)	273	●	○	○	11273	
	324	●	○	○	11324	
12S (10)	356	●	○	○	12356	
	406	●	○	○	12406	

● Standard Option



Please see pages 50 and 51 with detailed order examples for some of the most popular Heavy Series clamp assemblies.

③ Clamp Body Design & Material

Please select the design and material of your clamp body and add the corresponding **Code** to position ③ of the order code for your clamp assembly.

Please check the availability of the selected clamp body design and material according to the matrix table in ②.

Profiled Design

Polypropylene
Code: **PP**

Polypropylene (Colour: Black)
Code: **PP-BK**

Polyamide
Code: **PA**

Thermoplastic Elastomer (87 Shore-A)
Code: **SA** (for STAUFF Group 3S to 6S only)

Aluminium
Code: **AL**

Type H (Smooth)

Polypropylene
Code: **PP-H** (for STAUFF Group 3S to 6S only)

Polypropylene (Colour: Black; 3S to 6S only)
Code: **PP-H-BK**

Polyamide
Code: **PA-H** (for STAUFF Group 3S to 6S only)

Thermoplastic Elastomer (87 Shore-A)
Code: **SA-H** (for STAUFF Group 3S to 6S only)

Type RI (with Elastomer Insert)

Polypropylene
Code: **PP-R** (for STAUFF Group 4S to 10S only)

Polyamide
Code: **PA-R** (for STAUFF Group 4S to 10S only)

See pages 154 / 155 for material properties and technical information.

Please contact STAUFF for further details on fire-proof clamp body materials, tested and approved according to several international fire-protection standards.

④ Mounting & Fitting Combination

Please select the mounting and fitting combination (e.g. bolts, screws, cover plates etc.) and add the corresponding **Code** to position ④ of the order code for your clamp assembly.

Installation with Cover Plate and Bolts

Cover Plate for Single Clamps DPAL with Hexagon Head Bolts AS
Code: **DPAL-AS**

Cover Plate for Double Clamps DPAS with Hexagon Head Bolts AS
Code: **DPAS-AS**

Cover Plate for Single Clamps DPAL with Socket Cap Screws IS*
Code: **DPAL-IS** (for STAUFF Group 3S to 6S only)

Installation with Locking Plate and Bolts

Safety Locking Plate SIP with Stacking Bolts AF
Code: **SIP-AF**

Installation with Bolts only

Socket Cap Screws IS
Code: **IS**

* Special lengths of Socket Cap Screws IS required. For exact lengths, please see details of Hexagon Head Bolt, type AS (for use with Cover Plates DPAL or DPAS) on page 45.

⑤ Thread Type

Please select the required thread type and add the corresponding **Code** to position ⑤ of the order code for your clamp assembly.

Metric ISO thread
Code: **M**

Unified coarse (UNC) thread
Code: **U**

All threaded parts are available with Metric ISO thread or unified coarse (UNC) thread according to dimension table.

⑥ Material & Surface Finishing

Please select the required material & surface finishing of the metal parts and add the corresponding **Code** to position ⑥ of the order code for your clamp assembly.

Metal parts made of Carbon Steel, uncoated **W1**

Metal parts made of Carbon Steel, phosphated **W2**

Metal parts made of Carbon Steel, zinc/nickel-plated **W3**

Metal parts made of Stainless Steel V2A 1.4301 / 1.4305 (AISI 304 / 303) **W4**

Metal parts made of Stainless Steel V4A 1.4401 / 1.4571 (AISI 316 / 316 Ti) **W5**

Weld Plate made of Carbon Steel, phosphated; Other metal parts made of Carbon Steel, zinc/nickel-plated **W10**

Weld Plate and Cover Plate made of Carbon Steel, phosphated; Bolts made of Carbon Steel, uncoated **W12**

Mounting Rail Nuts made of Carbon Steel, zinc/nickel-plated; Cover Plate made of Carbon Steel, phosphated; Bolts made of Carbon Steel, uncoated **W13**

Weld Plate / Cover Plate made of Carbon Steel, phosphated; Bolts made of Carbon Steel, zinc/nickel-plated **W15**

Mounting Rail Nuts made of Carbon Steel, zinc/nickel-plated; Cover Plate made of Carbon Steel, phosphated; Bolts made of Carbon Steel, zinc/nickel-plated **W16**

Safety Locking Plate made of Carbon Steel, phosphated; Stacking Bolts made of Carbon Steel, zinc/nickel-plated **W17**

Safety Locking Plate made of Carbon Steel, uncoated; Stacking Bolts made of Carbon Steel, phosphated **W18**

Cover Plate made of Carbon Steel, phosphated; Bolts made of Carbon Steel, uncoated **W19**

Individual combinations of alternative materials and surface finishings are available upon request. Contact STAUFF for further information.

⑦ Assembling & Kitting

If required, please select an additional assembling and kitting option and add the corresponding **Code** to the last position of the order code for your clamp assembly.

Components supplied separately
Code: **none** (standard option)

Components assembled
Code: **A** (special option)

Components packed in kits
Code: **K** (special option)



B



- 2x **Hexagon Head Bolt**
Surface: W1
Thread: Metric
- 1x **Cover Plate for Single Clamps**
Surface: W2
- 1x **Clamp Body** (two halves)
STAUFF Group 3S (DIN 1)
O.D. 6 mm / .24 in
Material: Polypropylene
Profiled inside surface with tension clearance
- 1x **Weld Plate for Single Clamps**
Surface: W2
Thread: Metric

Order Code

SPAL-3006-PP-DPAL-AS-M-W12

W12 (STAUFF Group 3S to 7S) and W1 (STAUFF Group 8S to 12S) are the standard options for this type of installation.



- 4x **Hexagon Head Bolt**
Surface: W1
Thread: Metric
- 1x **Cover Plate for Double Clamps**
Surface: W2
- 2x **Clamp Body** (four halves)
STAUFF Group 3S (DIN 1)
O.D. 6 mm / .24 in
Material: Polypropylene
Profiled inside surface with tension clearance
- 1x **Weld Plate for Double Clamps**
Surface: W2
Thread: Metric

Order Code

SPAS-3006-PP-DPAS-AS-M-W12

W12 (STAUFF Group 3S to 7S) and W1 (STAUFF Group 8S to 12S) are the standard options for this type of installation.



- 2x **Hexagon Head Bolt**
Surface: W1
Thread: Metric
- 1x **Cover Plate for Single Clamps**
Surface: W2
- 1x **Clamp Body** (two halves)
STAUFF Group 3S (DIN 1)
O.D. 6 mm / .24 in
Material: Polypropylene
Profiled inside surface with tension clearance
- 1x **Elongated Weld Plate for Single Clamps**
Surface: W2
Thread: Metric

Order Code

SPAL-DUEB-3006-PP-DPAL-AS-M-W12

W12 (STAUFF Group 3S to 7S) and W1 (STAUFF Group 8S to 12S) are the standard options for this type of installation.



- 4x **Hexagon Head Bolt**
Surface: W1
Thread: Metric
- 1x **Cover Plate for Double Clamps**
Surface: W2
- 2x **Clamp Body** (four halves)
STAUFF Group 3S (DIN 1)
O.D. 6 mm / .24 in
Material: Polypropylene
Profiled inside surface with tension clearance
- 1x **Elongated Weld Plate for Double Clamps**
Surface: W2
Thread: Metric

Order Code

SPAS-DUEB-3006-PP-DPAS-AS-M-W12

W12 (STAUFF Group 3S to 7S) and W1 (STAUFF Group 8S to 12S) are the standard options for this type of installation.



- 2x **Socket Cap Screw**
Surface: W1
Thread: Metric
- 1x **Clamp Body** (two halves)
STAUFF Group 3S (DIN 1)
O.D. 6 mm / .24 in
Material: Polypropylene
Profiled inside surface with tension clearance
- 1x **Weld Plate for Single Clamps**
Surface: W2
Thread: Metric

Order Code

SPAL-3006-PP-IS-M-W12

W12 is the standard option for this type of installation. Available up to STAUFF Group 6S (DIN Group 4) only.



- 2x **Socket Cap Screw**
Surface: W1
Thread: Metric
- 1x **Clamp Body** (two halves)
STAUFF Group 3S (DIN 1)
O.D. 6 mm / .24 in
Material: Polypropylene
Profiled inside surface with tension clearance
- 1x **Elongated Weld Plate for Single Clamps**
Surface: W2
Thread: Metric

Order Code

SPAS-DUEB-3006-PP-IS-M-W12

W12 is the standard option for this type of installation. Available up to STAUFF Group 6S (DIN Group 4) only.





- 2x **Hexagon Head Bolt**
Surface: W1
Thread: Metric
- 1x **Cover Plate for Single Clamps**
Surface: W2
- 1x **Clamp Body** (two halves)
STAUFF Group 3S (DIN 1)
O.D. 6 mm / .24 in
Material: Polypropylene
Profiled inside surface with tension clearance
- 2x **Mounting Rail Nut**
Surface: W3
Thread: Metric

Order Code (Mounting Rail STSV not included.)

GMV-3006-PP-DPAL-AS-M-W13

W13 is the standard option for this type of installation. Available up to STAUFF Group 6S (DIN Group 4) only.



- 2x **Socket Cap Screw**
Surface: W1
Thread: Metric
- 1x **Clamp Body** (two halves)
STAUFF Group 3S (DIN 1)
O.D. 6 mm / .24 in
Material: Polypropylene
Profiled inside surface with tension clearance
- 2x **Mounting Rail Nut**
Surface: W3
Thread: Metric

Order Code (Mounting Rail STSV not included.)

GMV-3006-PP-IS-M-W13

W13 is the standard option for this type of installation. Available up to STAUFF Group 6S (DIN Group 4) only.



- 2x **Hexagon Head Bolt**
Surface: W1
Thread: Metric
- 1x **Cover Plate for Single Clamps**
Surface: W2
- 1x **Clamp Body** (two halves)
STAUFF Group 3S (DIN 1)
O.D. 6 mm / .24 in
Material: Polypropylene
Profiled inside surface with tension clearance

Order Code

3006-PP-DPAL-AS-M-W19

W19 (STAUFF Group 3S to 7S) and W1 (STAUFF Group 8S to 12S) are the standard options for this type of installation.



- 2x **Stacking Bolt**
Surface: W2
Thread: Metric
- 1x **Safety Locking Plate**
Surface: W2
- 1x **Clamp Body** (two halves)
STAUFF Group 3S (DIN 1)
O.D. 6 mm / .24 in
Material: Polypropylene
Profiled inside surface with tension clearance

Order Code

3006-PP-SIP-AF-M-W2

W2 (STAUFF Group 3S to 7S) and W18 (STAUFF Group 8S to 10S) are the standard options for this type of installation. Available up to STAUFF Group 10S (DIN Group 8) only.

Thread codes

All threaded parts are available with Metric ISO thread or unified coarse (UNC) thread according to dimension table.

Metric ISO thread	M
Unified coarse (UNC) thread	U









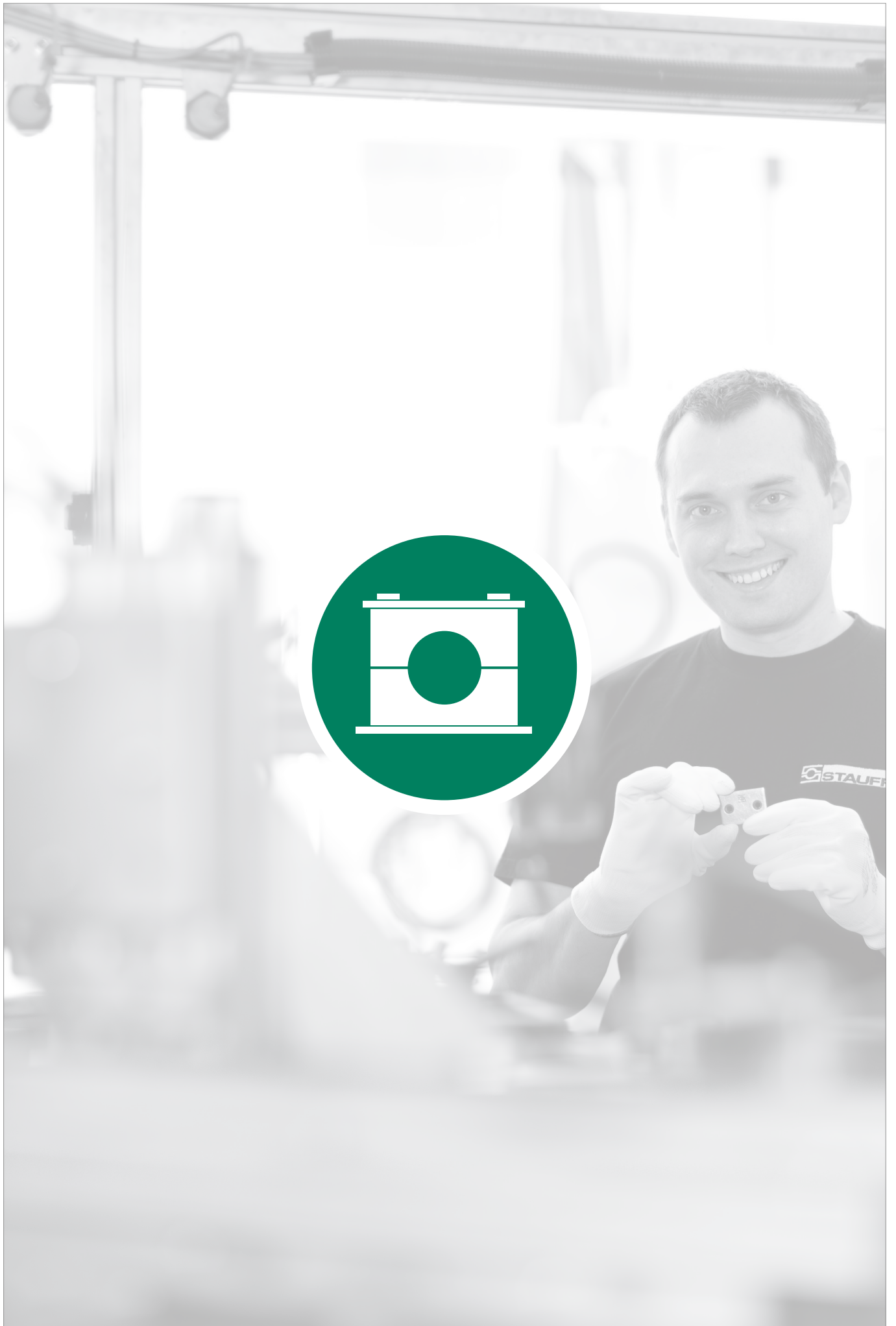



Material codes

The below listed material codes describe the materials and surface finishings of metal parts that are most relevant for Heavy Series clamp assemblies. Individual combinations of alternative materials and surface finishings are available upon request. Contact STAUFF for further information.

Metal parts made of Carbon Steel, uncoated	W1
Metal parts made of Carbon Steel, phosphated	W2
Metal parts made of Carbon Steel, zinc/nickel-plated	W3
Metal parts made of Stainless Steel V2A: 1.4301 / 1.4305 (AISI 304 / 303)	W4
Metal parts made of Stainless Steel V4A: 1.4401 / 1.4571 (AISI 316 / 316 Ti)	W5
Weld Plate made of Carbon Steel, phosphated; Other metal parts made of Carbon Steel, zinc/nickel-plated	W10
Weld Plate and Cover Plate made of Carbon Steel, phosphated; Bolts made of Carbon Steel, uncoated	W12
Mounting Rails Nut made of Carbon Steel, zinc/nickel-plated; Cover Plate made of Carbon Steel, phosphated; Bolts made of Carbon Steel, uncoated	W13
Weld Plate and Cover Plate made of Carbon Steel, phosphated; Bolts made of Carbon Steel, zinc/nickel-plated	W15
Mounting Rail Nuts made of Carbon Steel, zinc/nickel-plated; Cover Plate made of Carbon Steel, phosphated; Bolts made of Carbon Steel, zinc/nickel-plated	W16
Safety Locking Plate made of Carbon Steel, phosphated; Bolts made of Carbon Steel, zinc/nickel-plated	W17
Safety Locking Plate made of Carbon Steel, uncoated; Bolts made of Carbon Steel, phosphated	W18
Cover Plate made of Carbon Steel, phosphated; Bolts made of Carbon Steel, uncoated	W19





	Clamp Body Profiled Inside Surface with Tension Clearance	54		Single Weld Plate SP	55
	Clamp Body Smooth Inside Surface without Tension Clearance	54		Group Weld Plate RAP	55
				Hexagon Rail Nut SM	56
				Mounting Rail TS	56
				Channel Rail Adaptor CRA	57
				Cover Plate GD	58
				Hexagon Head Bolt AS	58
				Socket Cap Screw IS	59
				Safety Locking Plate SI	60
				Safety Locking Plate SIV	60
				Stacking Bolt AF	61
				Clamp Assemblies	62

C



Clamp Body - Profiled Design

Profiled Inside Surface with Tension Clearance

Clamp Body - Type H

Smooth Inside Surface w/o Tension Clearance

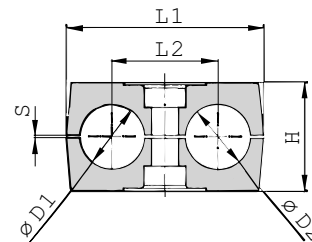

C

Ordering Codes

Clamp Body

***1*06/06*-PP**

One clamp body is consisting of two clamp halves.

- * 1st Part of STAUFF Group **1**
- * Exact outside diameters Ø D1 / Ø D2 (mm) **06/06**
- * Material code (see below) **PP**

Designs & Standard Materials

- Polypropylene - Profiled Design**
Profiled inside surface with tension clearance
Colour: Green
Material code: **PP**
- Polypropylene - Profiled Design**
Profiled inside surface with tension clearance
Colour: Black
Material code: **PP-BK**
- Polypropylene - Type H**
Smooth inside surface without tension clearance
Colour: Green
Material code: **PP-H**
- Polypropylene - Type H**
Smooth inside surface without tension clearance
Colour: Black
Material code: **PP-H-BK**
- Polyamide - Profiled Design**
Profiled inside surface with tension clearance
Colour: Black
Material code: **PA**
- Polyamide - Type H**
Smooth inside surface without tension clearance
Colour: Black
Material code: **PA-H**

See pages 154 / 155 for properties and technical information.

Special Materials

Please contact STAUFF for further details on fire-proof clamp body materials, tested and approved according to several international fire-protection standards (such as BS 6853, EN 45545-2, UL 94 and many more).

See pages 156 / 157 for material properties and technical information.

Product Features

- Proven, tested and trusted product in various markets
- Profiled design recommended for the safe installation of rigid pipes and tubes; type H recommended for the safe installation of hoses and cables
- Available for all commonly used pipe and tube outside diameters
- Environmental protection due to vibration/noise reducing design
- Excellent weathering resistance, even under extreme conditions

Group	STAUFF	DIN	Outside Diameter		Nominal Bore	Ordering Codes	Dimensions (mm/in)							
			Pipe / Tube / Hose	Pipe			Copper Tube	(2 Clamp Halves)	L1	L2	Profiled Design	Type H	Width	
			Ø D1 / Ø D2 (mm)	(in)	Pipe (in)	ASTM B88 (in)	(**-* = Material)			H	S min.	H		
1D	1		6				106/06-**-*							
			6,4	1/4			106.4/06.4-**-*							
			8	5/16			108/08-**-*	36	20	27	0,6	26,5	30	
			9,5	3/8		1/4	109.5/09.5-**-*	1.42	.79	1.06	.02	1.04	1.18	
			10			1/8	110/10-**-*							
			12				112/12-**-*							
2D	2		12,7	1/2		3/8	212.7/12.7-**-*							
			13,5			1/4	213.5/13.5-**-*							
			14				214/14-**-*							
			15				215/15-**-*	53	29	27	0,7	26	30	
			16	5/8		1/2	216/16-**-*	2.09	1.14	1.06	.03	1.02	1.18	
			17,2			3/8	217.2/17.2-**-*							
	18				218/18-**-*									
3D	3		19	3/4			319/19-**-*							
			20				320/20-**-*							
			21,3			1/2	321.3/21.3-**-*	67	36	37	0,7	36,5	30	
			22	7/8		3/4	322/22-**-*	2.64	1.42	1.46	.03	1.44	1.18	
			25				325/25-**-*							
	25,4	1			325.4/25.4-**-*									
4D	4		26,9			3/4	426.9/26.9-**-*							
			28				428/28-**-*	80	45	40	0,7	38	30	
			30				430/30-**-*	3.15	1.77	1.57	.03	1.46	1.18	
5D	5		32	1-1/4			532/32-**-*							
			33,7			1	533.7/33.7-**-*							
			35				1-1/4	535/35-**-*	106	56	53	0,7	52	30
			38	1-1/2			538/38-**-*	4.17	2.20	2.09	.03	2.04	1.18	
			40				540/40-**-*							
			42			1-1/4	542/42-**-*							

Additional outside diameters and combinations of different outside diameters are available upon request. Please contact STAUFF for further information.

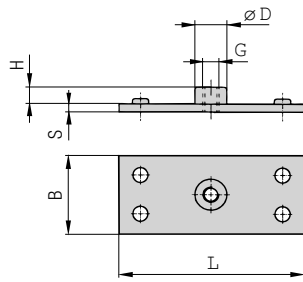

Single Weld Plate
Type SP

C

Group STAUFF	DIN	Dimensions (mm/in)						Ordering Codes (Standard Options)	
		L	B	S	H	ØD	Thread G		
1D	1	37	30	3	6,5	12	M6	SP-1D-M-W2	
		1.46	1.18	.12	.26	.47	1/4-20 UNC	SP-1D-U-W2	
2D	2	55	30	5	6	14	M8	SP-2D-M-W2	
		2.17	1.18	.20	.24	.55	5/16-18 UNC	SP-2D-U-W2	
3D	3	70	30	5	6	14	M8	SP-3D-M-W2	
		2.76	1.18	.20	.24	.55	5/16-18 UNC	SP-3D-U-W2	
4D	4	85	30	5	6	14	M8	SP-4D-M-W2	
		3.35	1.18	.20	.24	.55	5/16-18 UNC	SP-4D-U-W2	
5D	5	110	30	5	6	14	M8	SP-5D-M-W2	
		4.33	1.18	.20	.24	.55	5/16-18 UNC	SP-5D-U-W2	

Ordering Codes

Weld Plate

***SP-*1D-*M-*W2**

* Single Weld Plate		SP
* STAUFF Group		1D
* Thread code	Metric ISO thread	M
	Unified coarse (UNC) thread	U
* Material code	Carbon Steel, phosphated	W2
	Carbon Steel, zinc/nickel-plated	W3
	Stainless Steel V2A	W4
	1.4301 / 1.4305 (AISI 304 / 303)	W4
	Stainless Steel V4A	W5
	1.4401 / 1.4571 (AISI 316 / 316 Ti)	W5

All threaded parts are available with Metric ISO thread or unified coarse (UNC) thread according to dimension table.
Alternative materials and surface finishings are available upon request. Contact STAUFF for further information.

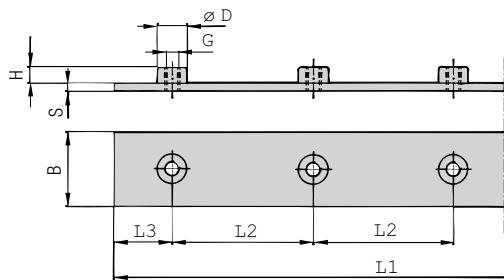
 Group Weld Plate
for 5 Clamp Bodies
Type RAP

Group STAUFF	DIN	Dimensions (mm/in)								Ordering Codes (Standard Options)	
		L1	L2	L3	B	S	H	ØD	Thread G		
1D	1	196	40	18	30	3	6,5	12	M6	RAP-1D-40-5-M-W1	
		7.72	1.57	.71	1.18	.12	.26	.47	1/4-20 UNC	RAP-1D-40-5-U-W1	
2D	2	288	58	28	30	5	6	14	M8	RAP-2D-58-5-M-W1	
		11.34	2.28	1.10	1.18	.20	.24	.55	5/16-18 UNC	RAP-2D-58-5-U-W1	
3D	3	358	72	35	30	5	6	14	M8	RAP-3D-72-5-M-W1	
		14.09	2.83	1.37	1.18	.20	.24	.55	5/16-18 UNC	RAP-3D-72-5-U-W1	
4D	4	444	90	42	30	5	6	14	M8	RAP-4D-90-5-M-W1	
		17.48	3.54	1.65	1.18	.20	.24	.55	5/16-18 UNC	RAP-4D-90-5-U-W1	
5D	5	558	112	55	30	5	6	14	M8	RAP-5D-112-5-M-W1	
		21.97	4.41	2.16	1.18	.20	.24	.55	5/16-18 UNC	RAP-5D-112-5-U-W1	

Ordering Codes

Weld Plate

***RAP-*1D-*40-*5-*M-*W1**

* Group Weld Plate		RAP
* STAUFF Group		1D
* Pipe Center Spacing L2 (mm)		40
* Number of Clamps		5
* Thread code	Metric ISO thread	M
	Unified coarse (UNC) thread	U
* Material code	Carbon Steel, uncoated	W1
	Carbon Steel, phosphated	W2
	Carbon Steel, zinc/nickel-plated	W3
	Stainless Steel V2A	W4
	1.4301 / 1.4305 (AISI 304 / 303)	W4
	Stainless Steel V4A	W5
	1.4401 / 1.4571 (AISI 316 / 316 Ti)	W5

All threaded parts are available with Metric ISO thread or unified coarse (UNC) thread according to dimension table.
Alternative materials and surface finishings are available upon request. Contact STAUFF for further information.



Hexagon Rail Nut

(for Use with Mounting Rail TS)

Type SM

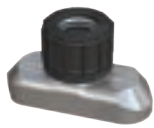

STAUFF Group 1D



STAUFF Group 2D to 5D

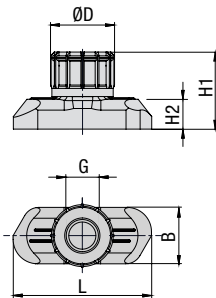

STAUFF Group 1D

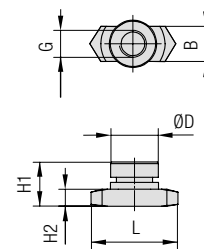

STAUFF Group 2D to 5D

Ordering Codes

Hexagon Rail Nut *SM-*1-8/1D-*M-*W3

* Hexagon Rail Nut		SM
* STAUFF Group	1D (DIN Group 1) 2D to 5D (DIN Group 2 to 5)	1-8/1D 2-5D
* Thread code	Metric ISO thread Unified coarse (UNC) thread	M U
* Material code	Carbon Steel, zinc/nickel-plated Stainless Steel V2A 1.4301 / 1.4305 (AISI 304 / 303) Stainless Steel V4A 1.4401 / 1.4571 (AISI 316 / 316 Ti)	W3 W4 W5

Group STAUFF	DIN	Dimensions (mm/in)						Ordering Codes (Standard Options)
		Thread G	L	B	H1	H2	ØD	
1D	1	M6	25,5	10,4	14,2	5,5	12	SM-1-8/1D-M-W3
		1/4-20 UNC	1.00	.41	.56	.22	.47	SM-1-8/1D-U-W3
2D	2							
3D	3	M8	25,5	10,4	13	5	14	SM-2-5D-M-W3
		5/16-18 UNC	1.00	.41	.51	.20	.55	SM-2-5D-U-W3
4D	4							
5D	5							

The Hexagon Rail Nut, type SM-1-8/1D is also suitable for Standard Series, STAUFF Group 1 to 8.

All threaded parts are available with Metric ISO thread or unified coarse (UNC) thread according to dimension table. Alternative materials and surface finishings are available upon request. Contact STAUFF for further information.

Mounting Rail

(for Use with Hexagon Rail Nut SM)

Type TS

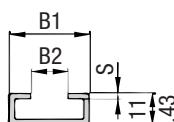

Mounting Rail TS-11

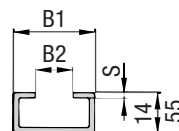

Mounting Rail TS-14

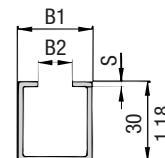

Mounting Rail TS-30

Ordering Codes

Mounting Rail *TS-*11-*1M-*W1

* Mounting Rail		TS
* Height of rail	11 mm / .43 in 14 mm / .55 in 30 mm / 1.18 in	11 14 30
* Length of rail	1 m / 3.28 ft 2 m / 6.56 ft	1M 2M
	Alternative lengths available upon request. Contact STAUFF for further information.	
* Material code	Carbon Steel, uncoated Carbon Steel, hot-dip galvanised Stainless Steel V2A 1.4301 / 1.4305 (AISI 304 / 303) Stainless Steel V4A 1.4401 / 1.4571 (AISI 316 / 316 Ti)	W1 W98 W4 W5

Group STAUFF	DIN	Dimensions (mm/in)			Ordering Codes (Standard Options)	
		B1	B2	S	Length of Rail: 1 m / 3.28 ft	Length of Rail: 2 m / 6.56 ft
1D	1				Height 11 mm / .43 in TS-11-1M-W1	Height 11 mm / .43 in TS-11-2M-W1
2D	2					
3D	3	28	11	2	Height 14 mm / .55 in TS-14-1M-W1	Height 14 mm / .55 in TS-14-2M-W1
		1.10	.43	.08		
4D	4					
5D	5				Height 30 mm / 1.18 in TS-30-1M-W1	Height 30 mm / 1.18 in TS-30-2M-W1

Mounting Rails, type TS-11/14/30 are suitable for all Twin Series and Standard Series group sizes.

Alternative materials and surface finishings are available upon request. Contact STAUFF for further information.

Dimensional drawings: All dimensions in mm (in).

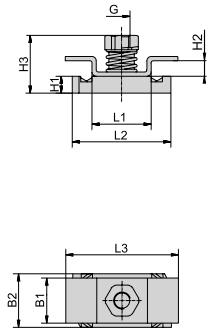
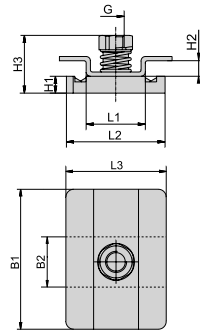

Channel Rail Adaptor (for Use with Various Channel Rails) Type CRA

STAUFF Group 1D

STAUFF Group 2-3D / 4-5D

Group STAUFF	DIN	Dimensions (mm/in)									Ordering Codes (Standard Options)	
		Thread G	L1	L2	L3	B1	B2	H1	H2	H3		
1D	1	M6	21	35	40	16	19	6	5,5	20,5	CRA-1-8/1D-M-W3	
		1/4-20 UNC	.83	1.38	1.57	.63	.75	.24	.22	.81	CRA-1-8/1D-U-W3	
2D	2	M8	21	35	38	53	19	9	5,5	23,5	CRA-2-3D-M-W3	
		5/16-18 UNC	.83	1.38	1.50	2.09	.75	.35	.22	.93	CRA-2-3D-U-W3	
3D	3											
4D	4	M8	21	35	38	80	19	9	5,5	23,5	CRA-4-5D-M-W3	
		5/16-18 UNC	.83	1.38	1.50	3.15	.75	.3	.22	.93	CRA-4-5D-U-W3	
5D	5											

Ordering Codes

Adaptor *CRA-*1-8/1D-*M-*W3

* Channel Rail Adaptor		CRA
* STAUFF Group	1D (DIN Group 1)	1-8/1D
	2D to 3D (DIN Group 2 to 3)	2-3D
	4D to 5D (DIN Group 4 to 5)	4-5D
* Thread code	Metric ISO thread	M
	Unified coarse (UNC) thread	U
* Material code	Carbon Steel, zinc/nickel-plated	W3
	Stainless Steel V4A	W5
	1.4401 / 1.4571 (AISI 316 / 316 Ti)	

The Channel Rail Adaptor, type CRA 1-8/1D is also suitable for Standard Series, STAUFF Group 1 to 8.

All threaded parts are available with Metric ISO thread or unified coarse (UNC) thread according to dimension table. Alternative materials and surface finishings are available upon request. Contact STAUFF for further information.



Compatibility with Channel Rails

The STAUFF Channel Rail Adaptor, type CRA, is suitable for various channel rails, including the following types:

HALFEN	HILTI	UNISTRUT®	STAUFF (Cushion Clamp Series)
HM 41/41	MQ-21, MQ-41, MQ-52, MQ-72	P1000, P1000T, P1000V, P1000VT, P1001	SCS-048-1-PL, SCS-048-1-GR
HZA 41/22	MQ-21U, MQ-41U, MQ-72U	P2000, P2000T	SCS-120-1-PL, SCS-120-1-GR
HZM 41/41	MQ-21D, MQ-41D, MQ-52-72D	P3003, P3003T, P3300V, P3300VT, P3301	See page 149 for technical information.
HZM 41/22		P4000, P4000T	
HL 41/41, HL 41/B2		P5000, P5000T, P5001, P5500, P5500T, P5501	

Contact STAUFF to check compatibility with additional types of channel rails.

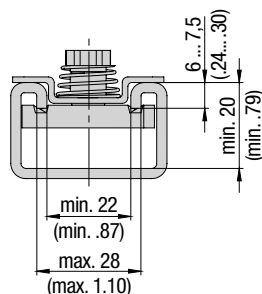

**Basic dimensional requirements for channel rails to be used with
STAUFF Channel Rail Adaptors, type CRA**

Dimensional drawings: All dimensions in mm (in).



Cover Plate Type GD

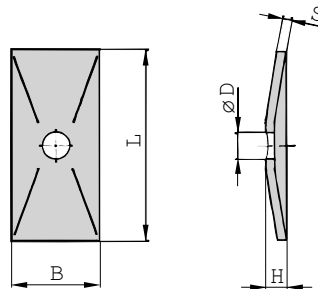

Ordering Codes

Cover Plate

***GD-*1D-*W3**

* Cover Plate		GD
* STAUFF Group		1D
* Material code	Carbon Steel, zinc/nickel-plated	W3
	Stainless Steel V2A	W4
	1.4301 / 1.4305 (AISI 304 / 303)	W4
	Stainless Steel V4A	W5
	1.4401 / 1.4571 (AISI 316 / 316 Ti)	W5

Group STAUFF	DIN	Dimensions (mm/in)					Ordering Codes (Standard Options)
		L	B	H	S	ØD	
1D	1	34	30	7	3	7	GD-1D-W3
		1.34	1.18	.28	.12	.28	
2D	2	52	30	7	3	9	GD-2D-W3
		2.05	1.18	.28	.12	.35	
3D	3	65	30	7	3	9	GD-3D-W3
		2.56	1.18	.28	.12	.35	
4D	4	79	30	7	3	9	GD-4D-W3
		3.11	1.18	.28	.12	.35	
5D	5	102	30	7	3	9	GD-5D-W3
		4.02	1.18	.28	.12	.35	

Alternative materials and surface finishings are available upon request. Contact STAUFF for further information.

Hexagon Head Bolt Type AS

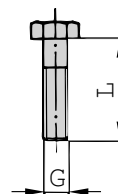

Hexagon Head Bolt AS

(according to DIN 931 / 933 or ANSI / ASME B18.2.1.)

Dimensions applicable only when used with Cover Plate GD

Ordering Codes

Hexagon Head Bolt *AS-*M8x35-*W3

* Type of bolt	Hexagon Head Bolt (according to DIN 931 / 933 or ANSI / ASME B18.2.1.)	AS
* Thread type and size acc. to dimension table	M8x35	
* Material code	Carbon Steel, zinc/nickel-plated	W3
	Stainless Steel V2A	W4
	1.4301 / 1.4305 (AISI 304 / 303)	W4
	Stainless Steel V4A	W5
	1.4401 / 1.4571 (AISI 316 / 316 Ti)	W5

Group STAUFF	DIN	Dimensions (mm/in)		Ordering Codes (Standard Options)
		Thread G x L		
1D	1	M6 x 35		AS-M6x35-W3
		1/4-20 UNC x 1-3/8		AS-1/4-20UNCx1-3/8-W3
2D	2	M8 x 35		AS-M8x35-W3
		5/16-18 UNC x 1-3/8		AS-5/16-18UNCx1-3/8-W3
3D	3	M8 x 45		AS-M8x45-W3
		5/16-18 UNC x 1-3/4		AS-5/16-18UNCx1-3/4-W3
4D	4	M8 x 50		AS-M8x50-W3
		5/16-18 UNC x 2		AS-5/16-18UNCx2-W3
5D	5	M8 x 60		AS-M8x60-W3
		5/16-18 UNC x 2-1/2		AS-5/16-18UNCx2-1/2-W3

All threaded parts are available with Metric ISO thread or unified coarse (UNC) thread according to dimension table. Alternative materials and surface finishings are available upon request. Contact STAUFF for further information.

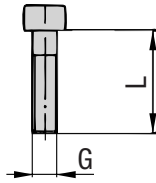

**Socket Cap Screw
Type IS**

Socket Cap Screw IS
(according to ISO 4762 or ANSI / ASME B18.3)
Dimensions applicable only when used with Cover Plate GD

C

Group STAUFF	DIN	Dimensions (mm/in) Thread G x L	Ordering Codes (Standard Options)
1D	1	M6 x 35	IS-M6x35-W3
		1/4-20 UNC x 1-3/8	IS-1/4-20UNCx1-3/8-W3
2D	2	M8 x 35	IS-M8x35-W3
		5/16-18 UNC x 1-3/8	IS-5/16-18UNCx1-3/8-W3
3D	3	M8 x 45	IS-M8x45-W3
		5/16-18 UNC x 1-3/4	IS-5/16-18UNCx1-3/4-W3
4D	4	M8 x 50	IS-M8x50-W3
		5/16-18 UNC x 2	IS-5/16-18UNCx2-W3
5D	5	M8 x 60	IS-M8x60-W3
		5/16-18 UNC x 2-1/2	IS-5/16-18UNCx2-1/2-W3

Ordering Codes
Socket Cap Screw *IS-*M8x35-*W3

* Type of bolt	Socket Cap Screw (according to ISO 4762 or ANSI / ASME B18.3)	IS
* Thread type and size acc. to dimension table	M8x35	
* Material code	Carbon Steel, zinc/nickel-plated	W3
	Stainless Steel V2A	W4
	1.4301 / 1.4305 (AISI 304 / 303)	
	Stainless Steel V4A	W5
	1.4401 / 1.4571 (AISI 316 / 316 Ti)	

All threaded parts are available with Metric ISO thread or unified coarse (UNC) thread according to dimension table.
Alternative materials and surface finishings are available upon request. Contact STAUFF for further information.



Safety Locking Plate

Type SI (for Use with Stacking Bolt AF)

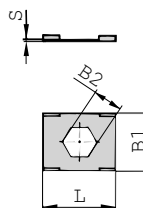

Safety Locking Plate SI
(Prevents Stacking Bolt from Loosening)

Ordering Codes

Safety Locking Plate ***SI-*1D-*W3**

- * Safety Locking Plate **SI**
- * STAUFF Group 1D (DIN Group 1) **1D**
2D to 5D (DIN Group 2 to 5) **2-5D**
- * Material code Carbon Steel, zinc/nickel-plated **W3**
Stainless Steel V2A **W4**
1.4301 / 1.4305 (AISI 304 / 303)
Stainless Steel V4A **W5**
1.4401 / 1.4571 (AISI 316 / 316 Ti)

Group STAUFF	DIN	Dimensions (mm / in)				Ordering Codes (Standard Options)
		L	B1	B2	S	
1D	1	27	22	11,2	0,5	SI-1D-W3
		1.06	.86	.44	.02	
2D	2	27	22	12,2	0,5	SI-2-5D-W3
3D	3					
4D	4					
5D	5	1.06	.86	.48	.02	

Alternative materials and surface finishings are available upon request. Contact STAUFF for further information.

Safety Locking Plate

Type SIV (for Use with Stacking Bolt AF)

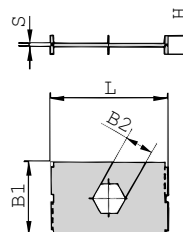

Safety Locking Plate SIV
(Prevents Stacking Bolt from Loosening and Upper Clamp from Turning)

Ordering Codes

Safety Locking Plate ***SIV-*1D-*W3**

- * Safety Locking Plate **SIV**
- * STAUFF Group 1D (DIN Group 1) **1D**
2D to 3D (DIN Group 2 to 3) **2-3D**
- * Material code Carbon Steel, zinc/nickel-plated **W3**
Stainless Steel V4A **W5**
1.4401 / 1.4571 (AISI 316 / 316 Ti)

Group STAUFF	DIN	Dimensions (mm / in)					Ordering Codes (Standard Options)
		L	B1	B2	S	H	
1D	1	27	28	11,1	1	7	SIV-1D-W3
		1.06	1.10	.44	.04	.27	
2D	2	45	28	12,1	1	7	SIV-2-3D-W3
3D	3						
		1.77	1.10	.48	.04	.27	

Alternative materials and surface finishings are available upon request. Contact STAUFF for further information.



Stacking Bolt

(for Use with Safety Locking Plates SI / SIV) Type AF

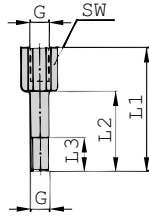
C

Group STAUFF	DIN	Dimensions (mm / in)					Hex	Ordering Codes (Standard Options)
		Thread G	L1	L2	L3 min.			
1D	1	M6	34	20	12	11	AF-1/1A/1D-M-W3	
		1/4-20 UNC	1.33	.78	.47	.43	AF-1/1A/1D-U-W3	
2D	2	M8	33	20	12	12	AF-2D-M-W3	
		5/16-18 UNC	1.30	.78	.47	.47	AF-2D-U-W3	
3D	3	M8	44	29	12	12	AF-3D-M-W3	
		5/16-18 UNC	1.73	1.14	.47	.47	AF-3D-U-W3	
4D	4	M8	49	34	12	12	AF-4D-M-W3	
		5/16-18 UNC	1.92	1.33	.47	.47	AF-4D-U-W3	
5D	5	M8	61	46	12	12	AF-5D-M-W3	
		5/16-18 UNC	2.40	1.81	.47	.47	AF-5D-U-W3	

Ordering Codes

Stacking Bolt *AF-*1/1A/1D-*M-*W3

* Stacking Bolt		AF
* STAUFF Group		1D
* Thread code	Metric ISO thread	M
	Unified coarse (UNC) thread	U
* Material code	Carbon Steel, zinc/nickel-plated	W3
	Stainless Steel V2A	W4
	1.4301 / 1.4305 (AISI 304 / 303)	
	Stainless Steel V4A	W5
	1.4401 / 1.4571 (AISI 316 / 316 Ti)	

All threaded parts are available with Metric ISO thread or unified coarse (UNC) thread according to dimension table. Alternative materials and surface finishings are available upon request. Contact STAUFF for further information.





Please see page 63 with detailed order examples for some of the most popular Twin Series clamp assemblies.

1 Type of Installation

Please select the type of installation (e.g. weld plates, rail nuts, etc.) and add the corresponding Code to position ① of the order code for your clamp assembly.

Without Installation Equipment
Code: **none**

Installation on Weld Plate

Single Weld Plate
Code: **SP**

Group Weld Plate
Code: **RAP**

Installation on Mounting / Channel Rail

Mounting Rail Nut
Code: **SM**

Channel Rail Adaptor
Code: **CRA**

2 Group Size & Diameters

Please select the required group size and diameter and add the corresponding Code to position ② of the order code for your clamp assembly.

Group	Outside Diameter	Availability of Clamp Body Materials & Designs		Code
		P / T / H	Type H	
STAUFF (DIN)	(mm)	Design	H	
1D (1)	6	●	●	106/06
	6,4	●	●	106.4/06.4
	8	●	●	108/08
	9,5	●	●	109.5/09.5
	10	●	●	110/10
	12	●	●	112/12
2D (2)	12,7	●	●	212.7/12.7
	13,5	●	●	213.5/13.5
	14	●	●	214/14
	15	●	●	215/15
	16	●	●	216/16
	17,2	●	●	217.2/17.2
3D (3)	18	●	●	218/18
	19	●	●	319/19
	20	●	●	320/20
	21,3	●	●	321.3/21.3
	22	●	●	322/22
	25	●	●	325/25
4D (4)	25,4	●	●	325.4/25.4
	26,9	●	●	426.9/26.9
	28	●	●	428/28
	30	●	●	430/30
	32	●	●	532/32
	33,7	●	●	533.7/33.7
5D (5)	35	●	●	535/35
	38	●	●	538/38
	40	●	●	540/40
	42	●	●	542/42

● Standard Option

3 Clamp Body Design & Material

Please select the design and material of your clamp body and add the corresponding Code to position ③ of the order code for your clamp assembly.

Please check the availability of the selected clamp body design and material according to the matrix table in ②.

Profiled Design

Polypropylene
Code: **PP**

Polypropylene (Colour: Black)
Code: **PP-BK**

Polyamide
Code: **PA**

Type H (Smooth)

Polypropylene
Code: **PP-H**

Polypropylene (Colour: Black)
Code: **PP-H-BK**

Polyamide
Code: **PA-H**

See pages 154 / 155 for material properties and technical information.

Please contact STAUFF for further details on fire-proof clamp body materials, tested and approved according to several international fire-protection standards.

4 Mounting & Fitting Combination

Please select the mounting and fitting combination (e.g. Bolts, Cover Plates, etc.) and add the corresponding Code to position ④ of the order code for your clamp assembly.

Installation with Cover Plate and Bolt

Cover Plate GD with Hexagon Head Bolt AS
Code: **GD-AS**

Cover Plate GD with Socket Cap Screw IS
Code: **GD-IS**

Installation with Locking Plate and Bolt

Safety Locking Plate SI with Stacking Bolt AF
Code: **SI-AF**

Safety Locking Plate SIV with Stacking Bolt AF
Code: **SIV-AF** (for STAUFF Group 1D to 3D only)

5 Thread Type

Please select the required thread type and add the corresponding Code to position ⑤ of the order code for your clamp assembly.

Metric ISO thread
Code: **M**

Unified coarse (UNC) thread
Code: **U**

All threaded parts are available with Metric ISO thread or unified coarse (UNC) thread according to dimension table.

6 Material & Surface Finishing

Please select the required material & surface finishing of the metal parts and add the corresponding Code to position ⑥ of the order code for your clamp assembly.

Metal parts made of Carbon Steel, zinc/nickel-plated **W3**

Metal parts made of Stainless Steel V2A 1.4301 / 1.4305 (AISI 304 / 303) **W4**

Metal parts made of Stainless Steel V4A 1.4401 / 1.4571 (AISI 316 / 316 Ti) **W5**

Weld Plate made of Carbon Steel, phosphated; Other metal parts made of Carbon Steel, zinc/nickel-plated **W10**

Individual combinations of alternative materials and surface finishings are available upon request. Contact STAUFF for further information.

7 Assembling & Kitting

If required, please select an additional assembling and kitting option and add the corresponding Code to the last position of the order code for your clamp assembly.

Components supplied separately
Code: **none** (standard option)

Components assembled
Code: **A** (special option)

Components packed in kits
Code: **K** (special option)





- 1x **Hexagon Head Bolt**
Surface: W3
Thread: Metric
- 1x **Cover Plate**
Surface: W3
- 1x **Clamp Body** (two halves)
STAUFF Group 1D (DIN 1)
both O.D. 6 mm / .24 in
Material: Polypropylene
Profiled inside surface
with tension clearance
- 1x **Weld Plate**
Surface: W2
Thread: Metric

Order Code

SP-106/06-PP-GD-AS-M-W10

W10 is the standard option for this type of installation.



- 1x **Hexagon Head Bolt**
Surface: W3
Thread: Metric
- 1x **Cover Plate**
Surface: W3
- 1x **Clamp Body** (two halves)
STAUFF Group 1D (DIN 1)
both O.D. 6 mm / .24 in
Material: Polypropylene
Profiled inside surface
with tension clearance

Order Code

106/06-PP-GD-AS-M-W3

W3 is the standard option for this type of installation.



- 1x **Stacking Bolt**
Surface: W3
Thread: Metric
- 1x **Safety Locking Plate (Type SI)**
Surface: W3
Thread: Metric
- 1x **Clamp Body** (two halves)
STAUFF Group 1D (DIN 1)
both O.D. 6 mm / .24 in
Material: Polypropylene
Profiled inside surface
with tension clearance

Order Code

106/06-PP-SI-AF-M-W3

W3 is the standard option for this type of installation.



- 1x **Stacking Bolt**
Surface: W3
Thread: Metric
- 1x **Safety Locking Plate (Type SIV)**
Surface: W3
Thread: Metric
- 1x **Clamp Body** (two halves)
STAUFF Group 1D (DIN 1)
both O.D. 6 mm / .24 in
Material: Polypropylene
Profiled inside surface
with tension clearance

Order Code

106/06-PP-SIV-AF-M-W3

W3 is the standard option for this type of installation.
This type of installation is available up to STAUFF Group 3D only.



- 1x **Hexagon Head Bolt**
Surface: W3
Thread: Metric
- 1x **Cover Plate**
Surface: W3
- 1x **Clamp Body** (two halves)
STAUFF Group 1D (DIN 1)
both O.D. 6 mm / .24 in
Material: Polypropylene
Profiled inside surface
with tension clearance
- 1x **Hexagon Rail Nut**
Surface: W3
Thread: Metric

Order Code (Mounting Rail TS not included.)

SM-106/06-PP-GD-AS-M-W3

W3 is the standard option for this type of installation.

Thread Codes

All threaded parts are available with Metric ISO thread or unified coarse (UNC) thread according to dimension table.

Metric ISO thread	M
Unified coarse (UNC) thread	U

Material Codes









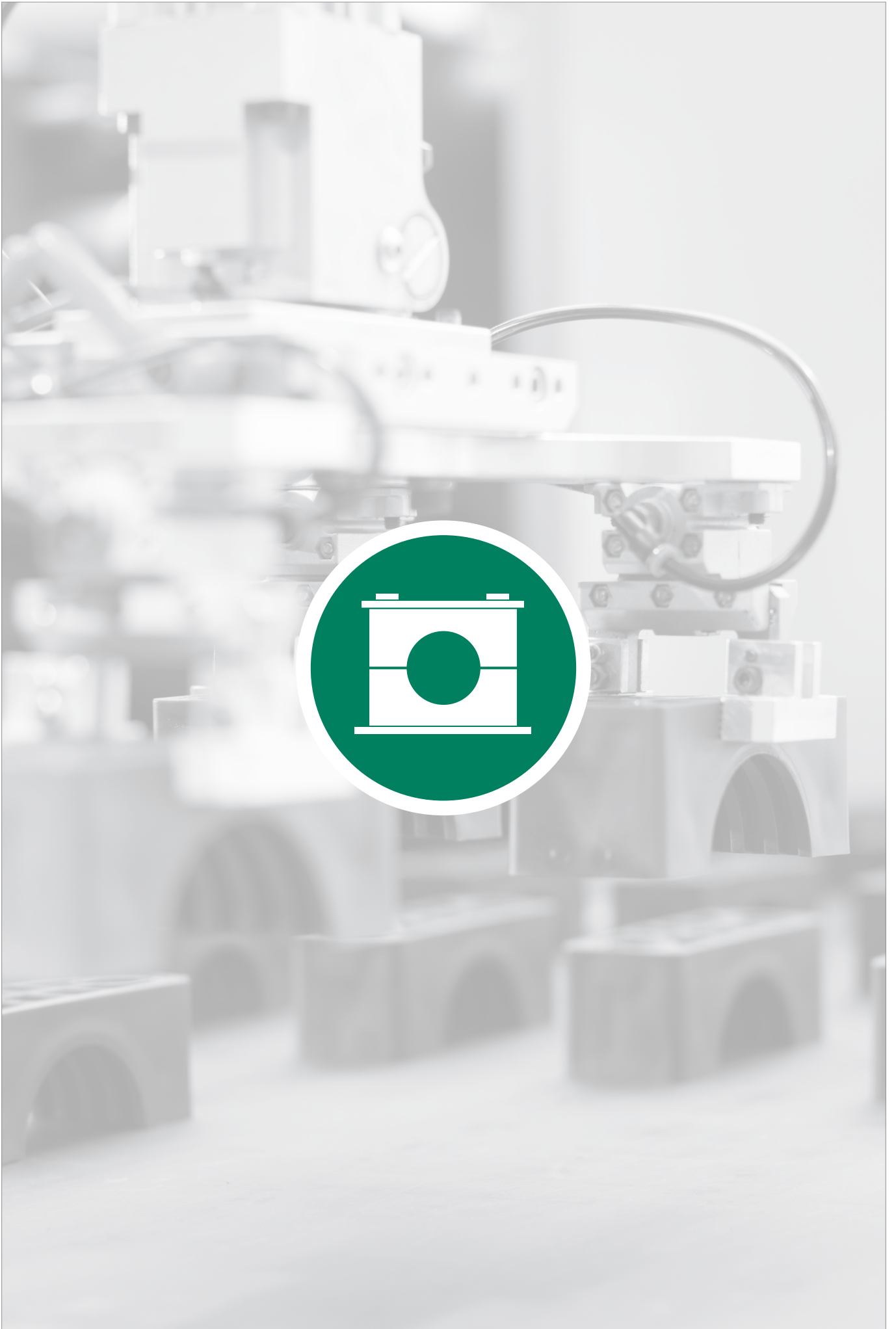

The below listed material codes describe the materials and surface finishings of metal parts that are most relevant for Twin Series clamp assemblies. Individual combinations of alternative materials and surface finishings are available upon request. Contact STAUFF for further information.

Metal parts made of Carbon Steel, zinc/nickel-plated	W3
Metal parts made of Stainless Steel V2A: 1.4301 / 1.4305 (AISI 304 / 303)	W4
Metal parts made of Stainless Steel V4A: 1.4401 / 1.4571 (AISI 316 / 316 Ti)	W5
Weld Plate made of Carbon Steel, phosphated	W10
Other metal parts made of Carbon Steel, zinc/nickel-plated	W10

C





	Clamp Body Profiled Inside Surface with Tension Clearance	66
	Clamp Body with Elastomer Inserts	66
	Weld Plate SPAD	67
	Cover Plate DPAD	67
	Hexagon Head Bolt AS	68
	Mounting Rail Nut GMV	68
	Mounting Rail STSV	68
	Channel Rail Adaptor CRA	68
	Socket Cap Screw IS	68
	Safety Locking Plate SIP	68
	Stacking Bolt AF	68
	Clamp Assemblies	69

D

Clamp Body - Profiled Design

Profiled Inside Surface with Tension Clearance

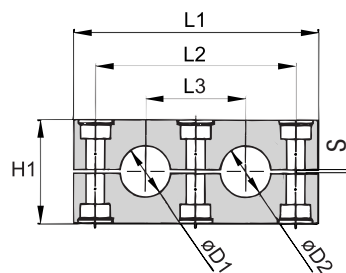
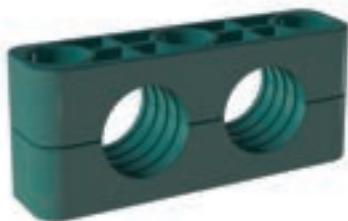

D

Ordering Codes

Clamp Body *4*012.7/12.7-*PP

One clamp body is consisting of two clamp halves.

- * 1st part of STAUFF Group **4**
- * Exact outside diameters Ø D1 / Ø D2 (mm) **012.7/12.7**
- * Material code (see below) **PP**

Standard Materials



Polypropylene
Colour: Green
Material code: **PP**



Polyamide
Colour: Black
Material code: **PA**

See pages 154 / 155 for material properties and technical information.

Group	Outside Diameter Pipe / Tube Ø D1 / Ø D2		Nominal Bore Pipe (in)	Copper Tube ASTM B88 (in)	Ordering Codes (2 Clamp Halves) (** = Material)	Dimensions (mm/in)					
	(mm)	(in)				L1	L2	L3	H1	S	Width
4S-D	12,7	1/2		3/8	4012.7/12.7-**-*	115 4.53	90 3.54	45 1.77	48 1.89	1,2 .05	30 1.18
	19	3/4			4019/19-**-*						
	20				4020/20-**-*						
	21,3		1/2		4021.3/21.3-**-*						
	22			3/4	4022/22-**-*						
	25,4	1			4025.4/25.4-**-*						
5S-D	26,9		3/4		4026.9/26.9-**-*	145 5.71	120 4.72	60 2.36	60 2.36	2,0 .08	30 1.18
	32	1-1/4			5032/32-**-*						
	33,7		1		5033.7/33.7-**-*						
	38	1-1/2			5038/38-**-*						
	42		1-1/4		5042/42-**-*						

Additional outside diameters and Clamp Bodies, type H (smooth inside surface without tension clearance) are available upon request. Please contact STAUFF for further information.

Clamp Body with Elastomer Inserts Type RI

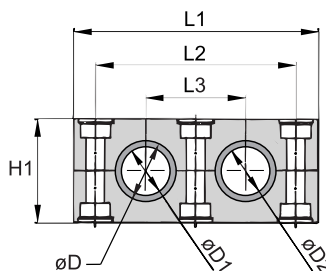

For use with Elastomer Inserts of the Heavy Series, STAUFF Group 4S and 5S (see page 39 for details)

Ordering Codes

Clamp Assembly *4*006/06-*PP-R

One assembly is consisting of one clamp body and two inserts.

- * 1st part of STAUFF Group **4**
- * Exact outside diameters Ø D1 / Ø D2 (mm) **006/06**
- * Material code (see below) **PP-R**

Standard Materials



Polypropylene
Colour: Black
Material code: **PP-R**



Polyamide
Colour: Black
Material code: **PA-R**



Elastomer Inserts
Thermoplastic Elastomer (73 Shore-A)
Colour: Black

Group	Outside Diameter Pipe / Tube / Hose Ø D1 / Ø D2		Ordering Codes (Clamp Assembly) (*** = Material)	Dimensions (mm/in)					
	(mm)	(in)		Ø D	L1	L2	L3	H1	Width
4S-D	6		4006/06-***-R	25 .98	115 4.53	90 3.54	45 1.77	48 1.89	30 1.18
	8	5/16	4008/08-***-R						
	10		4010/10-***-R						
	12		4012/12-***-R						
	12,7	1/2	4012.7/12.7-***-R						
	14		4014/14-***-R						
	15		4015/15-***-R						
	16	5/8	4016/16-***-R						
	17,2		4017.2/17.2-***-R						
	18		4018/18-***-R						
	19	3/4	4019/19-***-R						
5S-D	20		5020/20-***-R	38 1.50	145 5.71	120 4.72	60 2.36	60 2.36	30 1.18
	21,3		5021.3/21.3-***-R						
	22	7/8	5022/22-***-R						
	25		5025/25-***-R						
	26,9		5026.9/26.9-***-R						
	28		5028/28-***-R						
	30		5030/30-***-R						
32	1-1/4	5032/32-***-R							

See pages 154 / 155 for properties and technical information.

Additional outside diameters are available upon request. Please contact STAUFF for further information.

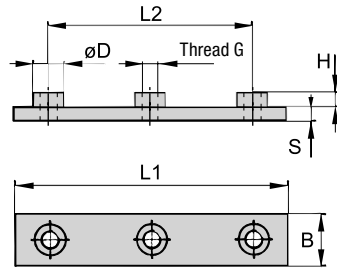

**Weld Plate
Type SPAD**

Group STAUFF	Dimensions (mm/in)		B	S	H	Thread G	ØD	Ordering Codes (Standard Options)
	L1	L2						
4S-D	130	90	30	8	8,5	M10	18	SPAD-4S-M-W1
	5.12	3.54	1.18	.31	.33	3/8-16 UNC	.71	SPAD-4S-U-W2*
5S-D	160	120	30	8	8,5	M10	18	SPAD-5S-M-W1
	6.30	4.72	1.18	.31	.33	3/8-16 UNC	.71	SPAD-5S-U-W2*

All threaded parts are available with Metric ISO thread or unified Coarse (UNC) thread according to dimension table. Alternative materials and surface finishings are available upon request. Contact STAUFF for further information.

* Standard finishing option in North America is W2 (Carbon Steel, phosphated).

Ordering Codes
Weld Plate
***SPAD-*4S-*M-*W1**

* Weld Plate		SPAD
* STAUFF Group	4S-D	4S
	5S-D	5S
* Thread code	Metric ISO thread	M
	Unified coarse (UNC) thread	U
* Material code	Carbon Steel, uncoated	W1
	Carbon Steel, phosphated	W2
	Carbon Steel, zinc/nickel-plated	W3
	Stainless Steel V2A	
	1.4301 / 1.4305 (AISI 304 / 303)	W4
	Stainless Steel V4A	
	1.4401 / 1.4571 (AISI 316 / 316 Ti)	W5

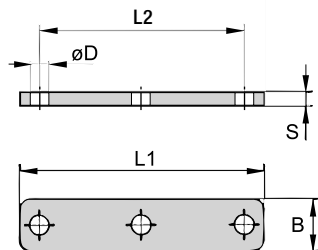
**Cover Plate
Type DPAD**

Group STAUFF	Dimensions (mm/in)		B	S	ØD	Ordering Codes (Standard Options)
	L1	L2				
4S	115	90	30	8	11	DPAD-4S-W1*
	4.53	3.54	1.18	.31	.43	
5S	145	120	30	8	11	DPAD-5S-W1*
	5.71	4.72	1.18	.31	.43	

All threaded parts are available with Metric ISO thread or unified Coarse (UNC) thread according to dimension table. Alternative materials and surface finishings are available upon request. Contact STAUFF for further information.

* Standard finishing option in North America is W3 (Carbon Steel, phosphated).

Ordering Codes
Cover Plate
***DPAD-*4S-*W1**

* Cover Plate		DPAD
* STAUFF Group	4S-D	4S
	5S-D	5S
* Material code	Carbon Steel, uncoated	W1
	Carbon Steel, phosphated	W2
	Carbon Steel, zinc/nickel-plated	W3
	Stainless Steel V2A	
	1.4301 / 1.4305 (AISI 304 / 303)	W4
	Stainless Steel V4A	
	1.4401 / 1.4571 (AISI 316 / 316 Ti)	W5



Hexagon Head Bolt Type AS

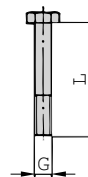

Hexagon Head Bolt AS

(according to DIN 931 / 933 or ANSI / ASME B18.2.1.)
Dimensions applicable only when used with Cover Plate DPAD

D

Ordering Codes

Hexagon Head Bolt *AS-*M10x70-*W1

* Type of bolt	Hexagon Head Bolt (according to DIN 931 / 933 or ANSI / ASME B18.2.1.)	AS
* Thread type and size acc. to dimension table	M10x70	
* Material code	Carbon Steel, uncoated	W1
	Carbon Steel, zinc/nickel-plated	W3
	Stainless Steel V2A 1.4301 / 1.4305 (AISI 304 / 303)	W4
	Stainless Steel V4A 1.4401 / 1.4571 (AISI 316 / 316 Ti)	W5

Group STAUFF	DIN	Dimensions (mm / in) Thread G x L	Ordering Codes (Standard Options)
4S	2	M10 x 60	AS-M10x60-W1
		3/8-16 UNC x 2-1/4	AS-3/8-16UNCx2-1/4-W3*
5S	3	M10 x 70	AS-M10x70-W1
		3/8-16 UNC x 2-3/4	AS-3/8-16UNCx2-3/4-W3*

All threaded parts are available with Metric ISO thread or unified coarse (UNC) thread according to dimension table. Alternative materials and surface finishings are available upon request. Contact STAUFF for further information.

If required, use Safety Washers, type SI as locking devices to prevent Hexagon Head Bolts, type AS from loosening. See page 46 for details.

* Standard finishing option in North America is W3 (Carbon Steel, zinc/nickel-plated).

Further Metal Hardware

For Use with the Heavy Twin Series



**Mounting Rail Nut
Type GMV**

Heavy Series, STAUFF Group 4S and 5S
(See page 42 for details)



**Mounting Rail
Type STSV**

Heavy Series
(See page 42 for details)



**Channel Rail Adaptor
Type CRA**

Heavy Series, STAUFF Group 4S and 5S
(See page 43 for details)



**Socket Cap Screw
Type IS**

Heavy Series, STAUFF Group 4S and 5S
(See page 45 for details)



**Safety Locking Plate
Type SIPD**

Heavy Twin Series, STAUFF Group 4S-D and 5S-D
(Contact STAUFF for details)



**Stacking Bolt
Type AF**

Heavy Series, STAUFF Group 4S and 5S
(See page 47 for details)





① Type of Installation

Please select the type of installation (e.g. Weld Plates, Rail Nuts etc.) and add the corresponding Code to position ① of the order code for your clamp assembly.

Without Installation Equipment
Code: **none**

Installation on Weld Plate

Single Weld Plate
Code: **SPAD**

Installation on Mounting / Channel Rail

Mounting Rail Nut
Code: **GMV**

Channel Rail Adaptor
Code: **CRA**

② Group Size & Diameters

Please select the required group size and diameter and add the corresponding Code to position ② of the order code for your clamp assembly.

Group	Outside Diameter P / T / H (mm)	Availability of Clamp Body Materials & Designs		Code
		Profiled Design	Type RI	
4S-D	6	○	●	4006/06
	8	○	●	4008/08
	10	○	●	4010/10
	12	○	●	4012/12
	12.7	●	●	4012.7/12.7
	14	○	●	4014/14
	15	○	●	4015/15
	16	○	●	4016/16
	17.2	○	●	4017.2/17.2
	18	○	●	4018/18
	19	●	●	4019/19
	20	●	○	4020/20
	21.3	●	○	4021.3/21.3
	22	●	○	4022/22
5S-D	25.4	●	○	4025.4/25.4
	26.9	●	○	4026.9/26.9
	20	○	●	5020/20
	21.3	○	●	5021.3/21.3
	22	○	●	5022/22
	25	○	●	5025/25
	26.9	○	●	5026.9/26.9
	28	○	●	5028/28
	30	○	●	5030/30
	32	●	●	5032/32
33.7	●	○	5033.7/33.7	
38	●	○	5038/38	
42	●	○	5042/42	

● Standard Option

③ Clamp Body Design & Material

Please select the design and material of your clamp body and add the corresponding Code to position ③ of the order code for your clamp assembly.

Please check the availability of the selected clamp body design and material according to the matrix table in ②.

Profiled Design

Polypropylene
Code: **PP**

Polyamide
Code: **PA**

Type RI (with Elastomer Insert)

Polypropylene
Code: **PP-R**

Polyamide
Code: **PA-R**

Clamp Bodies, Type H (smooth Inside surface without tension clearance) are available upon request. Please contact STAUFF for further information.

④ Mounting & Fitting Combination

Please select the mounting and fitting combination (e.g. Bolts, Cover Plates etc.) and add the corresponding Code to position ④ of the order code for your clamp assembly.

Installation with Cover Plate and Bolts

Cover Plate DPAD with Hexagon Head Bolt AS
Code: **DPAD-AS**

Installation with Locking Plate and Bolts

Safety Locking Plate SIPD with Stacking Bolt AF
Code: **SIPD-AF**

⑤ Thread Type

Please select the required thread type and add the corresponding Code to position ⑤ of the order code for your clamp assembly.

Metric ISO thread
Code: **M**

Unified coarse (UNC) thread
Code: **U**

All threaded parts are available with Metric ISO thread or unified coarse (UNC) thread according to dimension table.

⑥ Material & Surface Finishing

Please select the required material & surface finishing of the metal parts and add the corresponding Code to position ⑥ of the order code for your clamp assembly.

Metal parts made of Carbon Steel, uncoated **W1**

Metal parts made of Carbon Steel, phosphated **W2**

Metal parts made of Carbon Steel, zinc/nickel-plated **W3**

Metal parts made of Stainless Steel V2A 1.4301 / 1.4305 (AISI 304 / 303) **W4**

Metal parts made of Stainless Steel V4A 1.4401 / 1.4571 (AISI 316 / 316 Ti) **W5**

Weld Plate made of Carbon Steel, phosphated; Other metal parts made of Carbon Steel, zinc/nickel-plated **W10**

Weld Plate and Cover Plate made of Carbon Steel, phosphated; Bolts made of Carbon Steel, uncoated **W12**

Mounting Rail Nuts made of Carbon Steel, zinc/nickel-plated; Cover Plate made of Carbon Steel, phosphated; Bolts made of Carbon Steel, uncoated **W13**

Weld Plate / Cover Plate made of Carbon Steel, phosphated; Bolts made of Carbon Steel, zinc/nickel-plated **W15**

Mounting Rail Nuts made of Carbon Steel, zinc/nickel-plated; Cover Plate made of Carbon Steel, phosphated; Bolts made of Carbon Steel, zinc/nickel-plated **W16**

Safety Locking Plate made of Carbon Steel, phosphated; Bolts made of Carbon Steel, zinc/nickel-plated **W17**

Safety Locking Plate made of Carbon Steel, uncoated; Bolts made of Carbon Steel, phosphated **W18**

Cover Plate made of Carbon Steel, phosphated; Bolts made of Carbon Steel, uncoated **W19**

Individual combinations of alternative materials and surface finishings are available upon request. Contact STAUFF for further information.

⑦ Assembling & Kitting

If required, please select an additional assembling and kitting option and add the corresponding Code to the last position of the order code for your clamp assembly.



Components Supplied Separately
Code: **none** (Standard Option)

Components Assembled
Code: **A** (Special Option)

Components Packed in Kits
Code: **K** (Special Option)

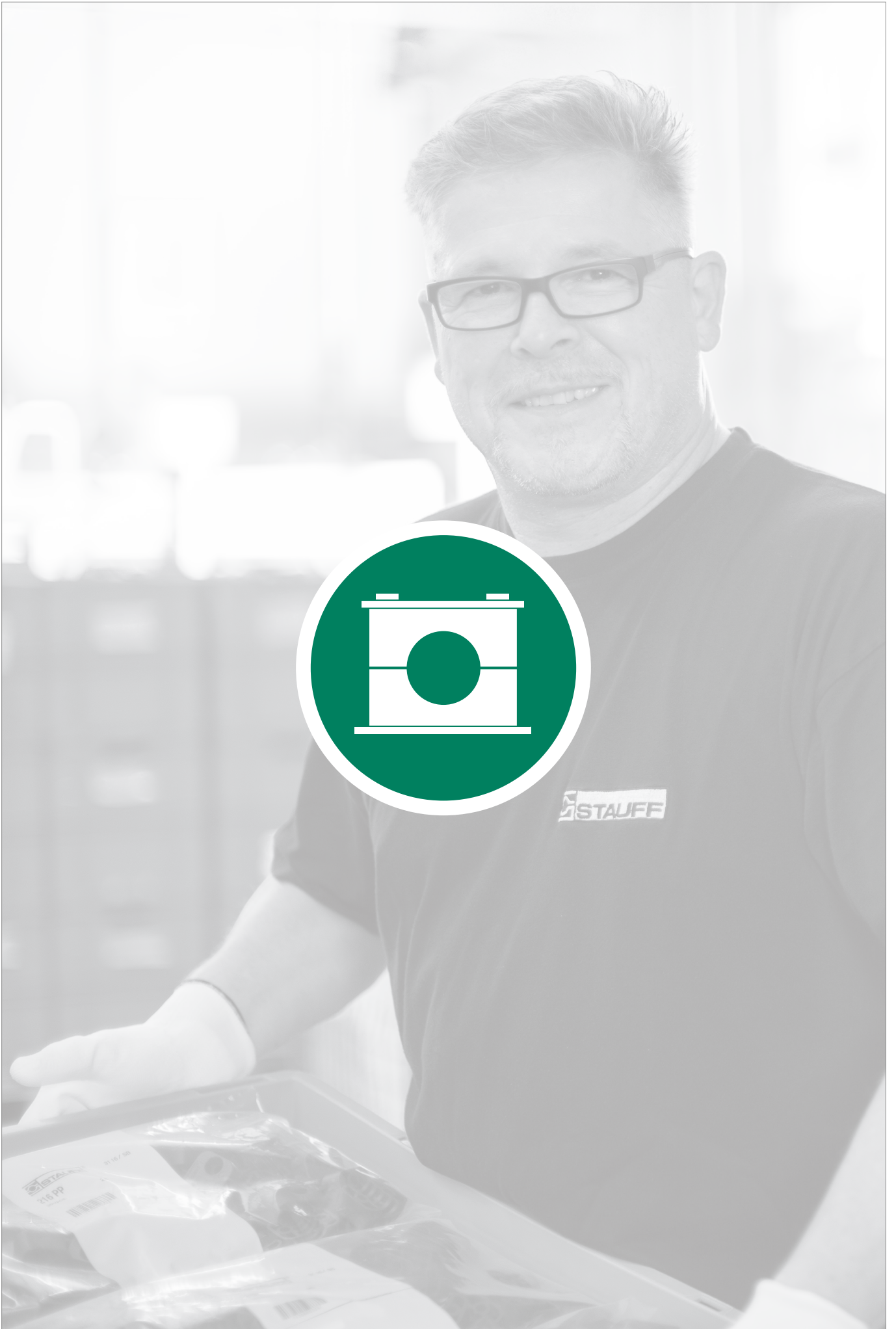
D

	Introduction	72
	Standard Series	74-81
	ACT Clamp Body	74
	Installation on Weld Plates	75
	Multi-Level Installation (with Weld Plate)	76
	Installation with Channel Rail Adaptors	77
	Installation in Field Trays / Cable Ladders	78
	Multi-Level Installation (with Stacking & Hammerhead Bolts)	79
	Multi-Level Installation in Field Trays / Cable Ladders (with Hammerhead Bolts)	80
	Clamp Assemblies	81
	Twin Series	82-89
	ACT Clamp Body	82
	Installation on Weld Plates	83
	Multi-Level Installation (with Weld Plate)	84
	Installation with Channel Rail Adaptors	85
	Installation in Field Trays / Cable Ladders	86
	Multi-Level Installation (with Stacking & Hammerhead Bolts)	87
	Multi-Level Installation in Field Trays / Cable Ladders (with Hammerhead Bolts)	88
	Clamp Assemblies	89



STAUFF ACT
Anti-Corrosion Technology

E



Crevice corrosion formed under a regular plastic clamp



Crevice corrosion formed under a regular plastic clamp



Stainless Steel Pipework

Stainless steel pipework on oil and gas platform and processing plants (that are located offshore and up to 50 km inland) is used over a wide range of temperature, flow and pressure conditions, e.g. for process instrumentation and sensing, as well as for chemical inhibition, hydraulic or utility lines.

The typical tubing material selected for these particular applications is AISI 316 stainless steel, although in more recent times other tube materials have been utilized to try and counteract the offshore corrosion issue.

In all major offshore oil and gas regions – including the Gulf of Mexico, the North Sea, the Gulf of Guinea and the China Sea – corrosion of AISI 316 stainless steel pipework can be observed, and has been a researched and well documented problem as well as a costly and time consuming issue with regard to maintenance processes for many years.

Pitting Corrosion

One of the most prevalent forms of localised corrosion is pitting corrosion: Under certain specific conditions – particularly involving chlorides (such as sodium chloride in seawater) and exacerbated by elevated temperatures – small pits can form in a stainless steel surface.

Dependent upon both the environment and the stainless steel itself, these pits may continue to grow and eventually lead to perforation of tubing walls and leaks, while the majority of the surface may still be totally unaffected.

Pitting corrosion is often quite easy to recognise: small individual pits and – in later stages – sometimes deeper and connected pits can be observed by visual inspection with the unaided eye.

Crevice Corrosion

Another dominant type is crevice corrosion, which is a lot more difficult to observe: It usually tends to occur in shielded areas such as crevices, formed under gaskets, washers, fastener heads, insulating material, surface deposits, disbanded coatings, threads and lap joints.

Pipe clamps made of plastic in particular have also been prone to inducing crevice corrosion in the past, because the plastic deforms around the tubing and creates even tighter crevices.

Crevice corrosion is always initiated by changes in the local chemistry within the shielded area, usually associated with a stagnant solution on the micro-environmental level:

- Trapped seawater becomes stagnant
- Depletion of inhibitor and oxygen
- A shift to acid conditions
- Build-up of aggressive ion species (such as sodium chloride in seawater)
- Accelerated corrosion process

Crevice corrosion can have serious and adverse consequences eventually leading to perforation of tubing walls and the escape of highly flammable and hazardous fluids and chemicals.

Material Selection

Hence, the selection of proper materials and the use of robust design and safe construction practices are mandatory, even if crevices are sometimes difficult or even impossible to avoid in tubing installations when using regular types of tubing supports and clamps.

This is where STAUFF ACT Clamps come into play ...

Corrosion Facts

Corrosion in general is a naturally occurring phenomenon commonly defined as the deterioration of a substance (usually a metal) or its properties because of a reaction with its environment. Like other natural hazards, corrosion can cause not only expensive but also dangerous damage to almost everything from automobiles, home appliances and drinking water systems to pipelines, bridges and public buildings.

Figures provided by the U.S. National Climatic Data Center underline that major weather related disasters the U.S. incurred total losses of averaging USD 17 billion annually (1980 – 2001). According to U.S. corrosion studies, the estimated direct cost of metallic corrosion in general was USD 276 billion on an annual basis in 1998. This represented 3,1% of the U.S. Gross Domestic Product.

Direct corrosion costs associated with the domestic oil and gas production activities in the U.S. were determined to be about USD 1,4 billion annually, with USD 0,6 billion attributed to surface piping and facility costs, USD 0,5 billion to downhole tubing, and USD 0,3 billion to capital expenditures related to corrosion.

The U.S. refineries represent approximately 23% of the world's petroleum production in 1996 supplying more than 18 million barrels of refined petroleum products per day, with a total corrosion related direct cost of USD 3,7 billion. Maintenance expenses make up USD 1,8 billion of this total, vessel expenses are USD 1,4 billion and fouling costs are approximately USD 0,5 billion annually.

Source of Information: Report No. FHWA-RD-01-156, September 2001 **Corrosion Costs and Preventive Strategies in the United States** Report by CC Technologies Laboratories, Inc. to Federal Highway Administration Office of Infrastructure Research and Development



Main Features

Efficient Prevention of Crevice Corrosion under Pipe Clamps on Stainless Steel Pipework
Middle- and Long-Term Cost Savings due to Extended Service and Maintenance Intervals

Technology protected
by utility model patent



Construction based on STAUFF Clamps

- Design based on Original STAUFF Clamps according to DIN 3015, Parts 1 and 3 (Standard Series and Twin Series), the tried and tested industry standard for several decades
- Covering the most commonly used metric and imperial pipe diameters from 6 mm to 42 mm (from 1/4 inch to 1 1/2 inch)
- Alternative configurations and pipe diameters on request
- Installation time reduction (compared to alternative designs)

Independent Testing and Approval

- Subject to stringent testing at the STAUFF in-house laboratories located in Werdohl (Germany)
- Salt spray tests according to ASTM B117 applied in controlled laboratory environments
- Long-term field tested on a rig in the Dutch sector of the North Sea
- Tests results independently assessed by Centre for Corrosion Technology at Sheffield Hallam University
- Fully detailed, independent test reports available on request

Innovative Design and Materials

- Material and design in compliance with section 7.3 (Tubing Installation) of the Norwegian offshore standard Norsok Z-010 (Revision 3, published in October 2000), API RP 552 and NACE SP 0108-2008 (section 13)
- 1 Clamp body made of flame-retardant PP-V0 plastic material; tested and V0 classified according to UL 94
- 2 Integrated ACE anti-corrosion elastomer strips avoid the accumulation of seawater between clamp body and pipe
- 3 Drainage channels aid the dispersal of seawater (self-draining)

- 4 ACT Mounting Hardware is made of Stainless Steel V4A (Material Code: W55) with enhanced corrosion resistance by practically excluding metallic and non-metallic impurities during production, processing and handling (delivered in hermetically-sealed quality storage bags with 25 pieces each to avoid contamination during transport)
- High UV stability of the clamp body material; resistant against seawater, rain and oil
- Suitable for continuous exposure to temperatures from -25 °C to +80 °C (from -13 °F to +176 °F)
- To be used in sub-sea and top-side environments; alleviating the requirement for two different products



Salt-spray testing of ACT Mounting Hardware (above of the picture) compared to contaminated hardware made of Stainless Steel V4A (below of the picture)

Design

STAUFF ACT Clamps are an innovatively designed solution for the installation of instrumentation pipework where anti-corrosion properties are of paramount importance (e.g. in the fields of offshore oil and gas exploration and processing).

The design – based on the tried and tested STAUFF Clamps according to DIN 3015 – offers installation time reduction and long term cost savings due to extended service intervals.

The STAUFF ACT clamp body design is available for the Standard Series (DIN 3015, Part 1) and the Twin Series (DIN 3015, Part 3) to cover the most commonly used metric and imperial pipe diameters from 6 mm to 42 mm (1/4 inch to 1 1/2 inch).

Development

Throughout their development, STAUFF ACT Clamps have been subject to stringent testing at the STAUFF in-house laboratories located in Werdohl, Germany.

In order to ensure credibility of the product, the development process has also involved independent testing.

In a controlled laboratory environment, continuous hot salt spray tests according to ASTM B117 have been applied for periods of 2000 hours to various clamp configurations holding AISI 316 stainless steel tubing.

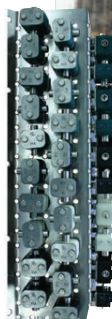

In addition to that, independent field test samples – located on an oil rig in the Dutch sector of the North Sea – have also been assessed at the Sheffield Hallam University facilities.

Both independent tests have recorded positive results in favour of the anti-corrosion attributes of the STAUFF ACT Clamp. Fully detailed test reports are available upon request.



To achieve this, the services of the Centre for Corrosion Technology at Sheffield Hallam University's Materials and Engineering Research Institute have been utilized, applying advanced techniques with equipment such as high resolution surface metrology and form measurement systems.

Conformity

Using flame-retardant PP-V0 plastic material for the clamp body and ACE anti-corrosion elastomer material for the rubber strips, STAUFF ACT Clamps have been constructed in compliance with section 7.3 (Tubing Installation) of the Norwegian offshore standard Norsok Z-010 (Revision 3, published in October 2000). They also comply with Norsok I-001 (Revision 4, published in January 2010), API RP 552 and NACE SP 0108-2008 (section 13).

The Norsok Organisation



Norsok is a Norwegian industry initiative to add value, reduce cost and lead time and remove unnecessary activities in offshore field developments and operations.

The Norsok standards are developed by the Norwegian petroleum industry and are jointly issued by the Norwegian Oil Industry Association (OLF) and the Federation of Norwegian Engineering Industries (TBL). They are administered by the Norwegian Technology Standards Institution (NTS).

The purpose of the Norsok industry standards is to replace the individual oil company specifications for use in existing and future petroleum industry developments, subject to the individual company's review and application.



Standard Series according to DIN 3015, Part 1
ACT Clamp Body



Integrated Rubber Strips
 made of Anti-Corrosion Elastomer (ACE)

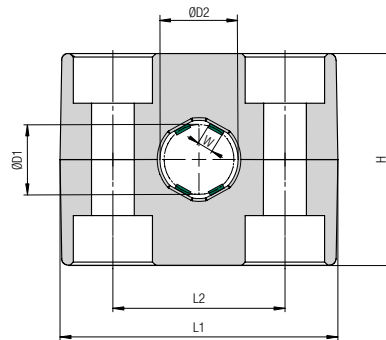

Ordering Codes

Clamp Body *2-*12.7-*ACT
 Clamp Body, STAUFF Group 1A *1-*06.4A-*ACT

One clamp body consists of two identical clamp halves, each with two integrated rubber strips.

- * STAUFF Group **2**
- * Exact outside diameter Ø D1 (mm) **12.7**
- * Material code **ACT**

Group Size		Outside Diameter Ø D1		Ordering Code	Packaging Unit	Dimensions (mm/in)					
STAUFF	DIN	(mm)	(in)	(2 Clamp Halves)	(in pieces / bag)	ØD2	W	L1	L2	H	Width
1A	1	3,2	1/8	103.2A-ACT	25	6,2 .24	1,1 .04	37 1.46	20 .79	26 1.06	30 1.18
		6		106A-ACT	25	9 .35	1,4 .06				
		6,4	1/4	106.4A-ACT	25	9,4 .37	1,5 .06				
		8		108A-ACT	25	11,0 .43	1,8 .07				
		9,5	3/8	109.5A-ACT	25	12,5 .49	2,2 .09				
		10		110A-ACT	25	13 .51	2,3 .09				
		12		112A-ACT	25	15 .59	2,8 .11				
2	2	12,7	1/2	212.7-ACT	25	15,7 .62	3,5 .14	42 1.65	26 1.02	32 1.30	30 1.18
		14		214-ACT	25	17 .67	3,5 .14				
		14,3	9/16	214.3-ACT	25	17,3 .68	3,5 .14				
		15		215-ACT	25	18 .71	3,5 .14				
		16	5/8	216-ACT	25	19 .74	3,5 .14				
		18		218-ACT	25	21 .83	3,5 .14				
3	3	19	3/4	319-ACT	25	22 .87	3,5 .14	50 1.97	33 1.30	35,5 1.42	30 1.18
		20		320-ACT	25	23 .91	3,5 .14				
		21,3		321.3-ACT	25	24,3 .96	3,5 .14				
		25		325-ACT	25	28 1.10	3,5 .14				
		25,4	1	325.4-ACT	25	28,4 1.12	3,5 .14				
4	4	26,9		426.9-ACT	25	31,1 1.22	6,0 .24	59 2.32	40 1.57	42 1,65	30 1.18
		28		428-ACT	25	32,2 1.27	6,0 .24				
		30		430-ACT	25	34,2 1.35	6,0 .24				
5	5	32	1 1/4	532-ACT	25	36,2 1.43	7 .28	71 2.80	52 2.05	58 2.28	30 1.18
		35		535-ACT	25	39,2 1.54	7 .28				
		38	1 1/2	538-ACT	25	42,2 1.66	8 .31				
		42		542-ACT	25	46,2 1.82	8 .31				

Additional sizes and outside diameters are available upon request.
 Please contact STAUFF for further information.





ACT Mounting Hardware Installation on Single Weld Plates

Required components (for use with single weld plate):

- 2 ACT Hexagon Head Bolts AS...W55
- 1 ACT Cover Plate DP...W55
- 1 ACT Clamp Body (2 Clamp Halves)
- 1 ACT Single Weld Plate SP...W55

Before welding, always make sure that the designated position of the ACT Weld Plate is suitable for the expected loads.

Material Code **W55** ACT Mounting Hardware Material Properties and Handling Instructions

ACT Mounting Hardware is made of Stainless Steel V4A (Material Code: W55) with enhanced corrosion resistance by practically excluding metallic and non-metallic impurities during production, processing and handling.

ACT Mounting Hardware is always delivered in hermetically-sealed quality storage bags with 25 pieces each to avoid contamination during transport.

Always make sure that ACT Mounting Hardware is stored separately from carbon steel and any other metals, and that appropriate tools are used to assemble the clamps.

Details: www.stauff.com/act/assembly

ACT Hexagon Head Bolt Type AS ... W55 (according to DIN 931 / 933)

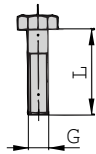

Dimensions applicable only when used with Cover Plate DP and Weld Plate SP



Group STAUFF	DIN	Dimensions (mm/in) Thread G x L	Ordering Code	Packaging Unit (in pieces / bag)
1A	1	M6 x 30	AS-M6x30-W55	25
		M6 x 1.18		
2	2	M6 x 35	AS-M6x35-W55	25
		M6 x 1.38		
3	3	M6 x 40	AS-M6x40-W55	25
		M6 x 1.57		
4	4	M6 x 45	AS-M6x45-W55	25
		M6 x 1.77		
5	5	M6 x 60	AS-M6x60-W55	25
		M6 x 2.36		

ACT Cover Plate Type DP ... W55

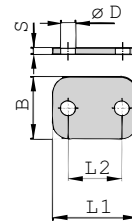

Group STAUFF	DIN	Dimensions (mm/in)					Ordering Code	Packaging Unit (in pieces / bag)
		L1	L2	B	S	ØD		
1A	1	34	20	30	3	7	DP-1A-W55	25
		1.34	.79	1.18	.12	.28		
2	2	40,5	26	30	3	7	DP-2-W55	25
		1.59	1.02	1.18	.12	.28		
3	3	48	33	30	3	7	DP-3-W55	25
		1.89	1.30	1.18	.12	.28		
4	4	57	40	30	3	7	DP-4-W55	25
		2.24	1.57	1.18	.12	.28		
5	5	70	52	30	3	7	DP-5-W55	25
		2.76	2.05	1.18	.12	.28		

ACT Single Weld Plate Type SP ... W55

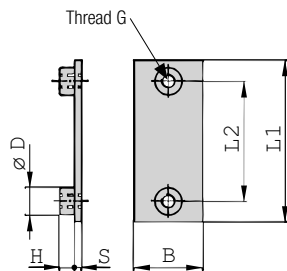

Group STAUFF	DIN	Dimensions (mm/in)						Ordering Code	Packaging Unit (in pieces / bag)	
		G	L1	L2	B	S	H			ØD
1A	1	M6	36	20	30	3	6,5	12	SP-1A-M-W55	25
			1.42	0.79	1.18	.12	.26	.47		
2	2	M6	42	26	30	3	6,5	12	SP-2-M-W55	25
			1.65	1.02	1.18	.12	.26	.47		
3	3	M6	50	33	30	3	6,5	12	SP-3-M-W55	25
			1.97	1.30	1.18	.12	.26	.47		
4	4	M6	60	40	30	3	6,5	12	SP-4-M-W55	25
			2.36	1.57	1.18	.12	.26	.47		
5	5	M6	71	52	30	3	6,5	12	SP-5-M-W55	25
			2.80	2.05	1.18	.12	.26	.47		

ACT Double Weld Plate Type SPD ... W55

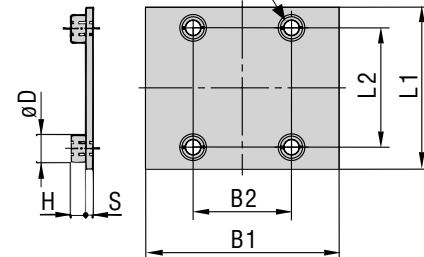

Group STAUFF	DIN	Dimensions (mm/in)							Ordering Code	Packaging Unit (in pieces / bag)	
		G	L1	L2	B1	B2	S	H			ØD
1A	1	M6	36	20	60	30,5	3	6,5	12	SPD-1A-M-W55	25
			1.42	0.79	2.36	1.20	.12	.26	.47		
2	2	M6	42	26	60	30,5	3	6,5	12	SPD-2-M-W55	25
			1.65	1.02	2.36	1.20	.12	.26	.47		
3	3	M6	50	33	60	30,5	3	6,5	12	SPD-3-M-W55	25
			1.97	1.30	2.36	1.20	.12	.26	.47		



Alternative types of weld plates are available upon request. Please contact STAUFF for further information.





ACT Mounting Hardware Multi-Level Installation (with Weld Plate)

Required components for each level:

- 2 ACT Stacking Bolt AF...W55
- 1 ACT Safety Locking Plate SIG...ACT-W55
- 1 ACT Clamp Body (2 Clamp Halves)

The upper layer is secured by a cover plate and hexagon head bolts. The lower layer has to be mounted to a weld plate (with a recommended maximum of two levels in total).

Material Code **W55** **ACT Mounting Hardware**
Material Properties and Handling Instructions

ACT Mounting Hardware is made of Stainless Steel V4A (Material Code: W55) with enhanced corrosion resistance by practically excluding metallic and non-metallic impurities during production, processing and handling.

ACT Mounting Hardware is always delivered in hermetically-sealed quality storage bags with 25 pieces each to avoid contamination during transport.

Always make sure that ACT Mounting Hardware is stored separately from carbon steel and any other metals, and that appropriate tools are used to assemble the clamps.
Details: www.stauff.com/act/assembly

ACT Stacking Bolt Type AF ... W55

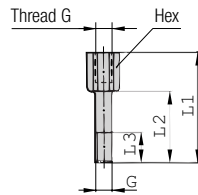

Group	STAUFF	DIN	Dimensions (mm /in)				Ordering Code	Packaging Unit (in pieces / bag)
			G	L1	L2	L3 min. Hex		
1A	1	M6	34	20	12	11	AF-1/1A/1D-M-W55	25
			1.34	.79	.47	.43		
2	2	M6	40	26	12	11	AF-2-M-W55	25
			1.57	1.24	.47	.43		
3	3	M6	44	30	12	11	AF-3-M-W55	25
			1.73	1.18	.47	.43		
4	4	M6	49	35	12	11	AF-4-M-W55	25
			1.93	1.38	.47	.43		
5	5	M6	64	50	12	11	AF-5-M-W55	25
			2.52	1.97	.47	.43		

ACT Safety Locking Plate Type SIG ... ACT-W55

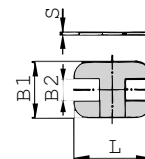

Group	STAUFF	DIN	Dimensions (mm /in)				Ordering Code	Packaging Unit (in pieces / bag)
			L	B1	B2	S		
1A	1		33	28	11,2	2	SIG-1A-ACT-W55	25
			1.30	1.10	.44	.08		
2	2		39	28	11,2	2	SIG-2-ACT-W55	25
			1.54	1.10	.44	.08		
3	3		47	28	11,2	2	SIG-3-ACT-W55	25
			1.85	1.10	.44	.08		
4	4		56	28	11,2	2	SIG-4-ACT-W55	25
			2.20	1.10	.44	.08		
5	5		69	28	11,2	2	SIG-5-ACT-W55	25
			2.72	1.10	.44	.08		





ACT Mounting Hardware Installation with Channel Rail Adaptors

Required components:

- 2 ACT Hexagon Head Bolts AS...W55
- 1 ACT Cover Plate DP...W55
- 1 ACT Clamp Body (2 Clamp Halves)
- 2 ACT Channel Rail Adaptors CRA...W55

Suitable for various brands and types of channel rails (including Halfen, Hilti, Unistrut® etc.).

Material Code **W55** ACT Mounting Hardware Material Properties and Handling Instructions

ACT Mounting Hardware is made of Stainless Steel V4A (Material Code: W55) with enhanced corrosion resistance by practically excluding metallic and non-metallic impurities during production, processing and handling.

ACT Mounting Hardware is always delivered in hermetically-sealed quality storage bags with 25 pieces each to avoid contamination during transport.

Always make sure that ACT Mounting Hardware is stored separately from carbon steel and any other metals, and that appropriate tools are used to assemble the clamps.

Details: www.stauff.com/act/assembly

ACT Hexagon Head Bolt Type AS ... W55 (according to DIN 931 / 933)

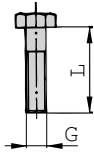

Dimensions applicable only when used with Cover Plate DP and Weld Plate SP



Group STAUFF	DIN	Dimensions (mm/in) Thread G x L	Ordering Code	Packaging Unit (in pieces / bag)
1A	1	M6 x 30	AS-M6x30-W55	25
		M6 x 1.18		
2	2	M6 x 35	AS-M6x35-W55	25
		M6 x 1.38		
3	3	M6 x 40	AS-M6x40-W55	25
		M6 x 1.57		
4	4	M6 x 45	AS-M6x45-W55	25
		M6 x 1.77		
5	5	M6 x 60	AS-M6x60-W55	25
		M6 x 2.36		

ACT Cover Plate Type DP ... W55

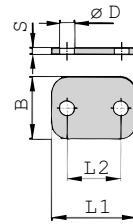

Group STAUFF	DIN	Dimensions (mm/in)					Ordering Code	Packaging Unit (in pieces / bag)
		L1	L2	B	S	ØD		
1A	1	34	20	30	3	7	DP-1A-W55	25
		1.34	.79	1.18	.12	.28		
2	2	40,5	26	30	3	7	DP-2-W55	25
		1.59	1.02	1.18	.12	.28		
3	3	48	33	30	3	7	DP-3-W55	25
		1.89	1.30	1.18	.12	.28		
4	4	57	40	30	3	7	DP-4-W55	25
		2.24	1.57	1.18	.12	.28		
5	5	70	52	30	3	7	DP-5-W55	25
		2.76	2.05	1.18	.12	.28		

ACT Channel Rail Adaptor Type CRA ... W55

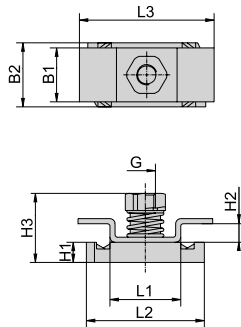

Group STAUFF	DIN	Dimensions (mm/in)									Ordering Code	Packaging Unit (in pieces / bag)
		G	L1	L2	L3	B1	B2	H1	H2	H3		
1A	1	M6	21 .83	35 1.38	40 1.57	16 .63	19 .75	6 .24	5,5 .22	20,5 .81	CRA-1-8/1D-M-W55	25
2	2											
3	3											
4	4											
5	5											

Suitability Chart for ACT Channel Rail Adaptors in the Standard Series

The STAUFF Channel Rail Adaptor, type CRA, is suitable for various brands and types of channel rails (including Halfen, Hilti, Unistrut® etc.). The drawing describes the basic dimensional requirements for channel rails to be used with STAUFF Channel Rail Adaptors, type CRA.

In case of doubt, please do not hesitate to contact STAUFF prior to field application.

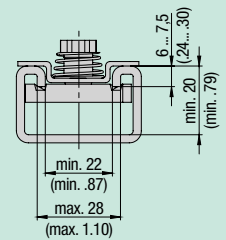

ACT Mounting Hardware Installation in Field Trays / Cable Ladders



Required components:

- 2 ACT Self-Locking Nuts MUS-HKS ... W55
- 1 ACT Cover Plate DP ... W55
- 1 ACT Clamp Body (2 Clamp Halves)
- 2 ACT Hammerhead Bolts HKS ... W55

Suitable for commonly used field trays and cable ladders with diagonal, lengthwise and/or crosswise slots and perforations.

Material Code **W55** ACT Mounting Hardware Material Properties and Handling Instructions

ACT Mounting Hardware is made of Stainless Steel V4A (Material Code: W55) with enhanced corrosion resistance by practically excluding metallic and non-metallic impurities during production, processing and handling.

ACT Mounting Hardware is always delivered in hermetically-sealed quality storage bags with 25 pieces each to avoid contamination during transport.

Always make sure that ACT Mounting Hardware is stored separately from carbon steel and any other metals, and that appropriate tools are used to assemble the clamps.

Details: www.stauff.com/act/assembly

All-Metal Self-Locking ACT Nut Type MUS-HKS ... W55 (similar to DIN 980 / Biloc)

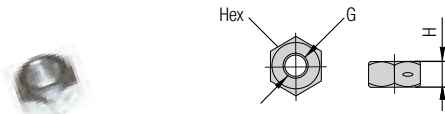

For use with ACT Hammerhead Bolts HKS ... W55



Group	STAUFF	DIN	Dimensions (mm/in)			Ordering Code	Packaging Unit
			Thread G	H	Hex		(in pieces / bag)
1A	1		M6	5	10	MUS-HKS-M6-W55	25
2	2						
3	3						
4	4						
5	5						

ACT Cover Plate Type DP ... W55

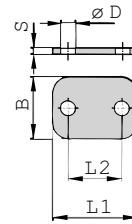

Group	STAUFF	DIN	Dimensions (mm/in)					Ordering Code	Packaging Unit
			L1	L2	B	S	ØD		(in pieces / bag)
1A	1		34	20	30	3	7	DP-1A-W55	25
			1.34	.79	1.18	.12	.28		
2	2		40,5	26	30	3	7	DP-2-W55	25
			1.59	1.02	1.18	.12	.28		
3	3		48	33	30	3	7	DP-3-W55	25
			1.89	1.30	1.18	.12	.28		
4	4		57	40	30	3	7	DP-4-W55	25
			2.24	1.57	1.18	.12	.28		
5	5		70	52	30	3	7	DP-5-W55	25
			2.76	2.05	1.18	.12	.28		

ACT Hammerhead Bolt Type HKS ... W55

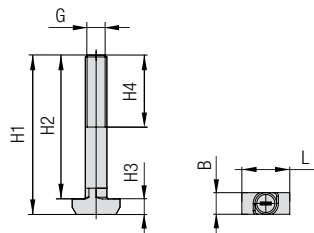

For use with Self-Locking ACT Nuts MUS-HKS ... W55



Group	STAUFF	DIN	Dimensions (mm/in)							Ordering Code	Packaging Unit
			G	H1	H2	H3	H4 min	B	L		(in pcs. / bag)
1A	1	M6	44,3	40	4,3	20	6,1	13,3	HKS-M6x40-W55	25	
			1.74	1.57	.17	.79	.24	.52			
2	2	M6	49,3	45	4,3	20	6,1	13,3	HKS-M6x45-W55	25	
			1.94	1.77	.17	.79	.24	.52			
3	3	M6	54,3	50	4,3	20	6,1	13,3	HKS-M6x50-W55	25	
			2.14	1.97	.17	.79	.24	.52			
4	4	M6	59,3	55	4,3	20	6,1	13,3	HKS-M6x55-W55	25	
			2.33	2.17	.17	.79	.24	.52			
5	5	M6	74,3	70	4,3	20	6,1	13,3	HKS-M6x70-W55	25	
			2.93	2.76	.17	.79	.24	.52			

Suitability Chart for ACT Hammerhead Bolts in the Standard Series

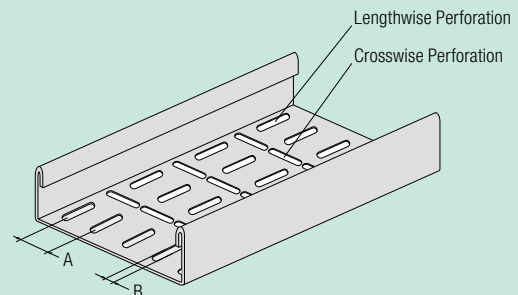

ACT Hammerhead Bolts are suitable for field trays and cable ladders with diagonal, lengthwise and/or crosswise slots and perforations that meet the following requirements:

- **Dimension A:** Equal to the bolt center spacing of the clamp assembly
- **Dimension B:** 6,2 mm ... 7,0 mm / .24 in28 in (Min ... Max)

In case of doubt, please do not hesitate to contact STAUFF prior to field application.



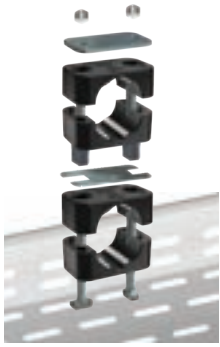

ACT Mounting Hardware Multi-Level Installation (with Stacking & Hammerhead Bolts)

Required components (for a recommended maximum of two levels in total):

- 2 ACT Self-Locking Nuts MUS-HKS ... W55
- 1 ACT Cover Plate DP ... W55
- 1 ACT Clamp Body (2 Clamp Halves)
- 1 ACT Safety Locking Plate SIG...ACT-W55
- 2 ACT Stacking Bolts AF-HKSK...W55
- 1 ACT Clamp Body (2 Clamp Halves)
- 2 ACT Hammerhead Bolts HKSK ... W55

Material Code
W55

ACT Mounting Hardware Material Properties and Handling Instructions

ACT Mounting Hardware is made of Stainless Steel V4A (Material Code: W55) with enhanced corrosion resistance by practically excluding metallic and non-metallic impurities during production, processing and handling.

ACT Mounting Hardware is always delivered in hermetically-sealed quality storage bags with 25 pieces each to avoid contamination during transport.

Always make sure that ACT Mounting Hardware is stored separately from carbon steel and any other metals, and that appropriate tools are used to assemble the clamps.

Details: www.stauff.com/act/assembly

All-Metal Self-Locking ACT Nut Type MUS-HKS ... W55 (similar to DIN 980 / Biloc)

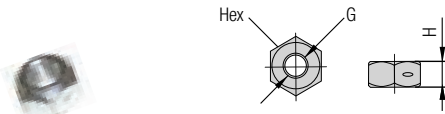

For use with ACT Stacking Bolts AF-HKS ... W55

Group	STAUFF	DIN	Dimensions (mm/in)			Ordering Code	Packaging Unit
			Thread G	H	Hex		(in pieces / bag)
1A	1		M6	5 .20	10 .39	MUS-HKS-M6-W55	25
2	2						
3	3						

ACT Cover Plate Type DP ... W55



Group	STAUFF	DIN	Dimensions (mm/in)					Ordering Code	Packaging Unit
			L1	L2	B	S	ØD		(in pieces / bag)
1A	1		34	20	30	3	7	DP-1A-W55	25
			1.34	.79	1.18	.12	.28		
2	2		40,5	26	30	3	7	DP-2-W55	25
			1.59	1.02	1.18	.12	.28		
3	3		48	33	30	3	7	DP-3-W55	25
			1.89	1.30	1.18	.12	.28		

ACT Stacking Bolt Type AF-HKSK ... W55



For use with Self-Locking ACT Nuts MUS-HKS ... W55

Group	STAUFF	DIN	Dimensions (mm/in)				Ordering Code	Packaging Unit
			G	L1	L2	L3 min. Hex		(in pieces / bag)
1A	1	M6	44	30	12	11	AF-HKSK-1A-M-W55	25
			1.73	1.18	.47	.43		
2	2	M6	54	40	12	11	AF-HKSK-2-M-W55	25
			2.13	1.57	.47	.43		
3	3	M6	54	40	12	11	AF-HKSK-3-M-W55	25
			2.13	1.57	.47	.43		

ACT Safety Locking Plate Type SIG ... ACT-W55



Group	STAUFF	DIN	Dimensions (mm/in)				Ordering Code	Packaging Unit
			L	B1	B2	S		(in pieces / bag)
1A	1		33	28	11,2	2	SIG-1A-ACT-W55	25
			1.30	1.10	.44	.08		
2	2		39	28	11,2	2	SIG-2-ACT-W55	25
			1.54	1.10	.44	.08		
3	3		47	28	11,2	2	SIG-3-ACT-W55	25
			1.85	1.10	.44	.08		

ACT Hammerhead Bolt Type HKSK ... W55



Group	STAUFF	DIN	Dimensions (mm/in)						Ordering Code	Packaging Unit	
			G	H1	H2	H3	H4 min	B	L		(in pcs. / bag)
1A	1	M6	29,3	25	4,3	20	6,1	13,3	HKSK-M6x25-W55	25	
			1.15	.98	.17	.79	.24	.52			
2	2	M6	36,3	32	4,3	20	6,1	13,3	HKSK-M6x32-W55	25	
			1.43	1.26	.17	.79	.24	.52			
3	3	M6	39,3	35	4,3	20	6,1	13,3	HKSK-M6x35-W55	25	
			1.55	1.38	.17	.79	.24	.52			





ACT Mounting Hardware Multi-Level Installation in Field Trays / Cable Ladders (with Hammerhead Bolts)

Required components (for a recommended maximum of two levels in total):

- 2 ACT Self-Locking Nuts MUS-HKS ... W55
- 1 ACT Cover Plate DP ... W55
- 1 ACT Clamp Body (2 Clamp Halves)
- 1 ACT Clamp Body (2 Clamp Halves)
- 2 ACT Hammerhead Bolts HKSV ... W55

Material Code **W55** ACT Mounting Hardware Material Properties and Handling Instructions

ACT Mounting Hardware is made of Stainless Steel V4A (Material Code: W55) with enhanced corrosion resistance by practically excluding metallic and non-metallic impurities during production, processing and handling.

ACT Mounting Hardware is always delivered in hermetically-sealed quality storage bags with 25 pieces each to avoid contamination during transport.

Always make sure that ACT Mounting Hardware is stored separately from carbon steel and any other metals, and that appropriate tools are used to assemble the clamps.
Details: www.stauff.com/act/assembly

All-Metal Self-Locking ACT Nut Type MUS-HKS ... W55 (similar to DIN 980 / Biloc)

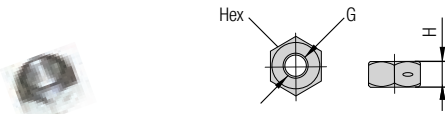

For use with ACT Hammerhead Bolts HKS ... W55



Group	STAUFF	DIN	Dimensions (mm/in)			Ordering Code	Packaging Unit
			Thread G	H	Hex		(in pieces / bag)
1A	1		M6	5 .20	10 .39	MUS-HKS-M6-W55	25
2	2						
3	3						

ACT Cover Plate Type DP ... W55

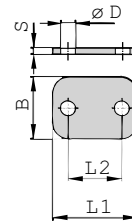

Group	STAUFF	DIN	Dimensions (mm/in)					Ordering Code	Packaging Unit
			L1	L2	B	S	ØD		(in pieces / bag)
1A	1		34	20	30	3	7	DP-1A-W55	25
			1.34	.79	1.18	.12	.28		
2	2		40,5	26	30	3	7	DP-2-W55	25
			1.59	1.02	1.18	.12	.28		
3	3		48	33	30	3	7	DP-3-W55	25
			1.89	1.30	1.18	.12	.28		

ACT Hammerhead Bolt Type HKSV ... W55

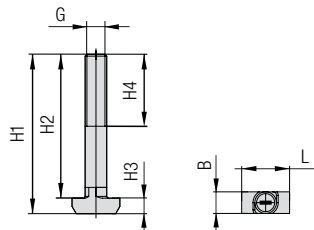

For use with Self-Locking ACT Nuts MUS-HKS ... W55



Group	STAUFF	DIN	Dimensions (mm/in)							Ordering Code	Packaging Unit
			G	H1	H2	H3	H4 min	B	L		(in pcs. / bag)
1A	1	M6	68,3	64	4,3	20	6,1	13,3	HKSV-M6x64-W55	25	
			2.69	2.52	.17	.79	.24	.52			
2	2	M6	80,3	76	4,3	20	6,1	13,3	HKSV-M6x76-W55	25	
			3.16	2.99	.17	.79	.24	.52			
3	3	M6	87,3	83	4,3	20	6,1	13,3	HKSV-M6x83-W55	25	
			3.44	3.27	.17	.79	.24	.52			

Suitability Chart for ACT Hammerhead Bolts in the Standard Series

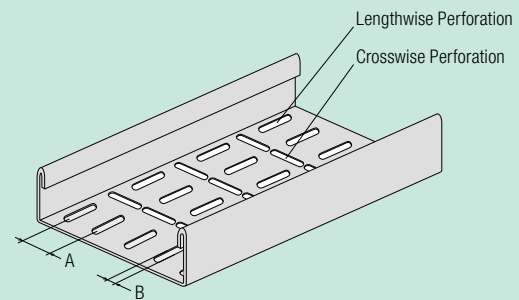

ACT Hammerhead Bolts are suitable for field trays and cable ladders with diagonal, lengthwise and/or crosswise slots and perforations that meet the following requirements:

- **Dimension A:** Equal to the bolt center spacing of the clamp assembly
- **Dimension B:** 6,2 mm ... 7,0 mm / .24 in28 in (Min ... Max)

In case of doubt, please do not hesitate to contact STAUFF prior to field application.



Installation on Weld Plate

Required components:

- 2 Hexagon Head Bolts AS...W55
- 1 Cover Plate DP...W55
- 1 ACT Clamp Body (2 Clamp Halves)
- 1 Single Weld Plate SP...W55

Before welding, always make sure that the designated position of the weld plate is suitable for the expected loads.

Multi-Level Installation (with Weld Plate)

Required components (for each level)
for a maximum of two levels in total:

- 2 Stacking Bolt AF...W55
- 1 Safety Locking Plate SIG...ACT-W55
- 1 ACT Clamp Body (2 Clamp Halves)

The upper layer has to be secured by a cover plate and hexagon head bolts. The lower level has to be mounted to a weld plate.

Order Code
SP-110a-ACT-DP-AS-M-W55

W55 is the recommended option for metal hardware to be used with STAUFF ACT Clamps.

Order Code
110a-ACT-SIG-AF-M-W55

W55 is the recommended option for metal hardware to be used with STAUFF ACT Clamps.

Installation with Channel Rail Adaptors

Required components:

- 2 Hexagon Head Bolts AS...W55
- 1 Cover Plate DP...W55
- 1 Clamp Body (2 Clamp Halves)
- 2 Channel Rail Adaptors CRA...W55

Suitable for various brands and types of channel rails (including Halfen, Hiiti, Unistrut® etc.).

Installation in Field Trays / Cable Ladders

Required components:

- 2 Self-Locking Nuts MUS-HKS ... W55
- 1 Cover Plate DP ... W55
- 1 Clamp Body (2 Clamp Halves)
- 2 Hammerhead Bolts HKS ... W55

Suitable for commonly used field trays and cable ladders with diagonal, lengthwise and/or crosswise slots and perforations.

Order Code
CRA-110a-ACT-DP-AS-M-W55

W55 is the recommended option for metal hardware to be used with STAUFF ACT Clamps.

Order Code
HKS-110a-ACT-DP-MUS-M-W55

W55 is the recommended option for metal hardware to be used with STAUFF ACT Clamps.

**Multi-Level Installation
in Field Trays / Cable Ladders**

Required components
(for a maximum of two levels in total):

- 2 Self-Locking Nuts MUS-HKS ... W55
- 1 Cover Plate DP ... W55
- 1 ACT Clamp Body (2 Clamp Halves)
- 1 Safety Locking Plate SIG...ACT-W55
- 2 Stacking Bolts AF-HKSK...W55
- 1 ACT Clamp Body (2 Clamp Halves)
- 2 Hammerhead Bolts HKSK ... W55

Suitable for commonly used field trays and cable ladders with diagonal, lengthwise and/or crosswise slots and perforations.

**Multi-Level Installation
in Field Trays / Cable Ladders**

Required components
(for a maximum of two levels in total):

- 2 Self-Locking Nuts MUS-HKS ... W55
- 1 Cover Plate DP ... W55
- 1 ACT Clamp Body (2 Clamp Halves)
- 1 ACT Clamp Body (2 Clamp Halves)
- 2 Hammerhead Bolts HKSV ... W55

Suitable for commonly used field trays and cable ladders with diagonal, lengthwise and/or crosswise slots and perforations.

Order Codes

Upper Level: **HKSK-212.7-ACT-DP-MUS-M-W55**
Lower Level: **212.7-ACT-SIG-AF-HKSK-M-W55**

W55 is the recommended option for metal hardware to be used with STAUFF ACT Clamps.

Order Codes

Upper Level: **212.7-ACT** (Clamp Body only)
Lower Level: **HKSV-212.7-ACT-DP-MUS-M-W55**

W55 is the recommended option for metal hardware to be used with STAUFF ACT Clamps.

E

Twin Series according to DIN 3015, Part 3
ACT Clamp Body

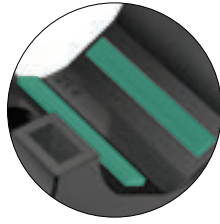

Integrated Rubber Strips
 made of Anti-Corrosion Elastomer (ACE)

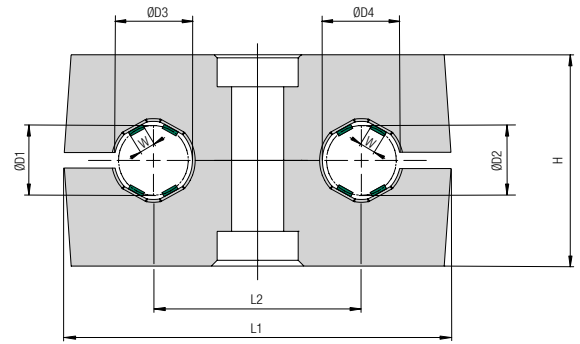

Ordering Codes

Clamp Body *2*12.7/12.7-*ACT

One clamp body consists of two identical clamp halves, each with four integrated rubber strips.

- * 1st Part of STAUFF Group **2**
- * Exact outside diameters Ø D1 / Ø D2 (mm) **12.7/12.7**
- * Material code **ACT**

E

Group Size		Outside Diameters Ø D1 / Ø D2		Ordering Code	Packaging Unit	Dimensions (mm/in)					
STAUFF	DIN	(mm)	(in)	(2 Clamp Halves)	(in pieces / bag)	ØD3 / ØD4	W	L1	L2	H	Width
1D	1	6		106/06-ACT	25	9 .35	1,4 .06	36 1.42	20 .79	26,6 1.05	30 1.18
		6,4	1/4	106.4/06.4-ACT	25	9,4 .37	1,5 .06				
		9,5	3/8	109.5/09.5-ACT	25	12,5 .49	2,2 .09				
		10		110/10-ACT	25	13 .51	2,3 .09				
		12		112/12-ACT	25	15 .59	2,8 .11				
2D	2	12,7	1/2	212.7/12.7-ACT	25	15,7 .62	3,5 .14	53 2.09	29 1.14	26,6 1.05	30 1.18
		14		214/14-ACT	25	17 .67	3,5 .14				
3D	3	18		318/18-ACT	25	21 .83	3,5 .14	67 2.64	36 1.42	36,6 1.44	30 1.18
		19	3/4	319/19-ACT	25	22 .87	3,5 .14				
		20		320/20-ACT	25	23 .91	3,5 .14				
		21,3		321.3/21.3-ACT	25	24,3 .96	3,5 .14				
		25,4	1	325.4/25.4-ACT	25	28,4 1.12	3,5 .14				

Additional outside diameters and combinations of different outside diameters are available upon request.
 Please contact STAUFF for further information.



ACT Mounting Hardware Installation on Single Weld Plates



Required components:

- 1 ACT Hexagon Head Bolt AS...W55
- 1 ACT Cover Plate GD...W55
- 1 ACT Clamp Body (2 Clamp Halves)
- 1 ACT Single Weld Plate SP...W55

Before welding, always make sure that the designated position of the ACT Weld Plate is suitable for the expected loads.

Material Code **W55** ACT Mounting Hardware Material Properties and Handling Instructions

ACT Mounting Hardware is made of Stainless Steel V4A (Material Code: W55) with enhanced corrosion resistance by practically excluding metallic and non-metallic impurities during production, processing and handling.

ACT Mounting Hardware is always delivered in hermetically-sealed quality storage bags with 25 pieces each to avoid contamination during transport.

Always make sure that ACT Mounting Hardware is stored separately from carbon steel and any other metals, and that appropriate tools are used to assemble the clamps.

Details: www.stauff.com/act/assembly

ACT Hexagon Head Bolt Type AS ... W55 (according to DIN 931 / 933)

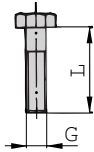

Dimensions applicable only when used with Cover Plate GD and Weld Plate SP



Group	STAUFF	DIN	Dimensions (mm/in) Thread G x L	Ordering Code	Packaging Unit (in pieces / bag)
1D	1		M6 x 35	AS-M6x35-W55	25
			M6 x 1.38		
2D	2		M8 x 35	AS-M8x35-W55	25
			M8 x 1.38		
3D	3		M8 x 45	AS-M8x45-W55	25
			M8 x 1.77		

ACT Cover Plate Type GD ... W55

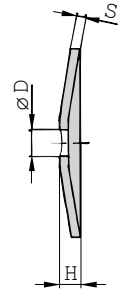
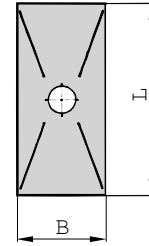

Group	STAUFF	DIN	Dimensions (mm/in)					Ordering Code	Packaging Unit (in pieces / bag)
			L	B	H	S	ØD		
1D	1		34	30	7	3	7	GD-1D-W55	25
			1.34	1.18	.28	.12	.28		
2D	2		52	30	7	3	9	GD-2D-W55	25
			2.05	1.18	.28	.12	.35		
3D	3		65	30	7	3	9	GD-3D-W55	25
			2.56	1.18	.28	.12	.35		

ACT Single Weld Plate Type SP ... W55

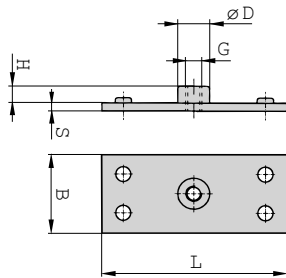

Group	STAUFF	DIN	Dimensions (mm/in)						Ordering Code	Packaging Unit (in pieces / bag)
			G	L	B	S	H	ØD		
1D	1	M6	37	30	3	6.5	12	SP-1D-M-W55	25	
			1.46	1.18	.12	.26	.47			
2D	2	M8	55	30	5	6	14	SP-2D-M-W55	25	
			2.17	1.18	.20	.24	.55			
3D	3	M8	70	30	5	6	14	SP-3D-M-W55	25	
			2.76	1.18	.20	.24	.55			



ACT Mounting Hardware Multi-Level Installation (with Weld Plate)



Required components for each level:

- 1 ACT Stacking Bolt AF...W55
- 1 ACT Safety Locking Plate SIV...ACT
- 1 ACT Clamp Body (2 Clamp Halves)

The upper layer is secured by a cover plate and hexagon head bolts. The lower layer has to be mounted to a weld plate (with a recommended maximum of two levels in total).

Material Code **W55** ACT Mounting Hardware Material Properties and Handling Instructions

ACT Mounting Hardware is made of Stainless Steel V4A (Material Code: W55) with enhanced corrosion resistance by practically excluding metallic and non-metallic impurities during production, processing and handling.

ACT Mounting Hardware is always delivered in hermetically-sealed quality storage bags with 25 pieces each to avoid contamination during transport.

Always make sure that ACT Mounting Hardware is stored separately from carbon steel and any other metals, and that appropriate tools are used to assemble the clamps.
Details: www.stauff.com/act/assembly

ACT Stacking Bolt Type AF ... W55

E

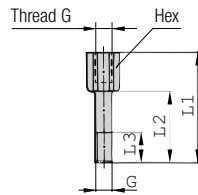

Group	STAUFF	DIN	Dimensions (mm/in)					Order Code	Packaging Unit (in pieces / bag)
			G	L1	L2	L3 min.	Hex		
1D	1	M6	34	20	12	11	AF-1/1A/1D-M-W55	25	
			1.33	.78	.47	.43			
2D	2	M8	33	20	11	12	AF-2D-M-W55	25	
			1.30	.78	.43	.47			
3D	3	M8	44	29	15	12	AF-3D-M-W55	25	
			1.73	1.14	.59	.47			

ACT Safety Locking Plate Type SIV ... ACT

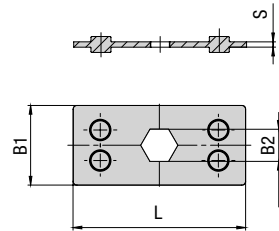

Made of flame-retardant PP-V0 plastic material; tested and V0 classified according to UL 94

Group	STAUFF	DIN	Dimensions (mm/in)				Order Code	Packaging Unit (in pieces / bag)
			L	B1	B2	S		
1D	1		34	30	11,2	2	SIV-1D-PP-V0-ACT	25
			1.39	1.18	.44	.08		
2D	2		52	30	12,1	2	SIV-2D-PP-V0-ACT	25
			2.05	1.18	.48	.08		
3D	3		65	30	12,1	2	SIV-3D-PP-V0-ACT	25
			2.56	1.18	.48	.08		



ACT Mounting Hardware Installation with Channel Rail Adaptors



Required components:

- 1 ACT Hexagon Head Bolt AS...W55
- 1 ACT Cover Plate GD...W55
- 1 ACT Clamp Body (2 Clamp Halves)
- 1 ACT Channel Rail Adaptor CRA...W55

Suitable for various brands and types of channel rails (including Halfen, Hilti, Unistrut® etc.).

Material Code **W55** ACT Mounting Hardware Material Properties and Handling Instructions

ACT Mounting Hardware is made of Stainless Steel V4A (Material Code: W55) with enhanced corrosion resistance by practically excluding metallic and non-metallic impurities during production, processing and handling.

ACT Mounting Hardware is always delivered in hermetically-sealed quality storage bags with 25 pieces each to avoid contamination during transport.

Always make sure that ACT Mounting Hardware is stored separately from carbon steel and any other metals, and that appropriate tools are used to assemble the clamps.

Details: www.stauff.com/act/assembly

ACT Hexagon Head Bolt Type AS ... W55 (according to DIN 931 / 933)

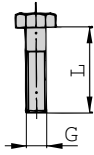

Dimensions applicable only when used with Cover Plate GD and Weld Plate SP



Group STAUFF	DIN	Dimensions (mm/in) Thread G x L	Ordering Code	Packaging Unit (in pieces / bag)
1D	1	M6 x 35	AS-M6x35-W55	25
		M6 x 1.38		
2D	2	M8 x 35	AS-M8x35-W55	25
		M8 x 1.38		
3D	3	M8 x 45	AS-M8x45-W55	25
		M8 x 1.77		

ACT Cover Plate Type GD ... W55

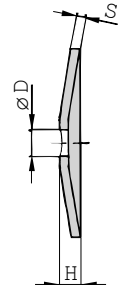
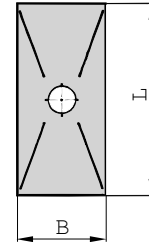

Group STAUFF	DIN	Dimensions (mm/in)					Ordering Code	Packaging Unit (in pieces / bag)
		L	B	H	S	ØD		
1D	1	34	30	7	3	7	GD-1D-W55	25
		1.34	1.18	.28	.12	.28		
2D	2	52	30	7	3	9	GD-2D-W55	25
		2.05	1.18	.28	.12	.35		
3D	3	65	30	7	3	9	GD-3D-W55	25
		2.56	1.18	.28	.12	.35		

Channel Rail Adaptor Type CRA ... W55

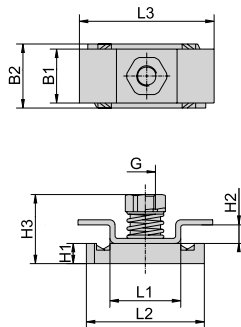

Group STAUFF	DIN	Dimensions (mm/in) G	L1	L2	L3	B1	B2	H1	H2	H3	Order Code	Packaging Unit (in pieces / bag)
1D	1	M6	21	35	40	16	19	6	5,5	20,5	CRA-1-8/1D-M-W55	25
			.83	1.38	1.57	.63	.75	.24	.22	.81		
2D	2	M8	21	35	38	53	19	9	5,5	23,5	CRA-2-3D-M-W55	25
3D	3		.83	1.38	1.50	2.09	.75	.35	.22	.93		

Suitability Chart for ACT Channel Rail Adaptors in the Twin Series

The STAUFF Channel Rail Adaptor, type CRA, is suitable for various brands and types of channel rails (including Halfen, Hilti, Unistrut® etc.). The drawing describes the basic dimensional requirements for channel rails to be used with STAUFF Channel Rail Adaptors, type CRA.

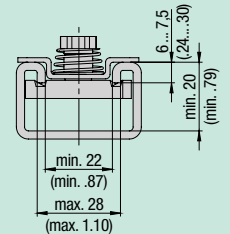

In case of doubt, please do not hesitate to contact STAUFF prior to field application.



ACT Mounting Hardware Installation in Field Trays / Cable Ladders



Required components:

- 1 ACT Self-Locking Nut MUS-HKS ... W55
- 1 ACT Cover Plate GD ... W55
- 1 ACT Clamp Body (2 Clamp Halves)
- 1 ACT Hammerhead Bolt HKS ... W55

Suitable for commonly used field trays and cable ladders with diagonal, lengthwise and/or crosswise slots and perforations.

Material Code **W55** ACT Mounting Hardware Material Properties and Handling Instructions

ACT Mounting Hardware is made of Stainless Steel V4A (Material Code: W55) with enhanced corrosion resistance by practically excluding metallic and non-metallic impurities during production, processing and handling.

ACT Mounting Hardware is always delivered in hermetically-sealed quality storage bags with 25 pieces each to avoid contamination during transport.

Always make sure that ACT Mounting Hardware is stored separately from carbon steel and any other metals, and that appropriate tools are used to assemble the clamps.
Details: www.stauff.com/act/assembly

All-Metal Self-Locking ACT Nut Type MUS-HKS ... W55 (similar to DIN 980 / Biloc)

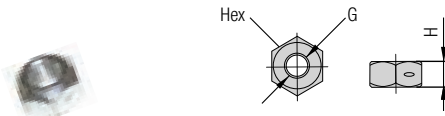

For use with ACT Hammerhead Bolts HKS ... W55

Group STAUFF	DIN	Dimensions (mm/in)	Hex	Ordering Code	Packaging Unit (in pieces / bag)
		Thread G	H		
1D	1	M6	5	MUS-HKS-M6-W55	25
			.20		
2D	2	M8	6,5	MUS-HKS-M8-W55	25
			.26		
3D	3				

ACT Cover Plate Type GD ... W55

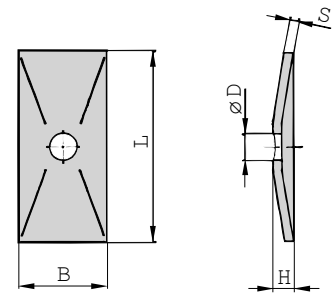

Group STAUFF	DIN	Dimensions (mm/in)	Ordering Code	Packaging Unit (in pieces / bag)				
		L	B	H	S	ØD		
1D	1	34	30	7	3	7	GD-1D-W55	25
		1.34	1.18	.28	.12	.28		
2D	2	52	30	7	3	9	GD-2D-W55	25
		2.05	1.18	.28	.12	.35		
3D	3	65	30	7	3	9	GD-3D-W55	25
		2.56	1.18	.28	.12	.35		

ACT Hammerhead Bolt Type HKS ... W55

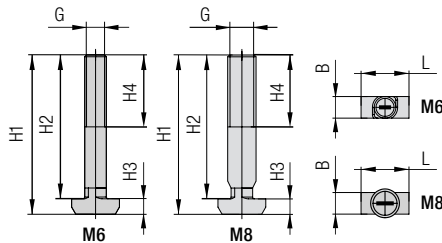

For use with Self-Locking ACT Nuts MUS-HKS ... W55

Group STAUFF	DIN	Dimensions (mm/in)	Ordering Code	Packaging Unit (in pcs. / bag)						
		G	H1	H2	H3	H4 min	B	L		
1D	1	M6	49,3	45	4,3	20	6,1	13,3	HKS-M6x45-W55	25
			1.94	1.77	.17	.79	.24	.52		
2D	2	M8	49,3	45	4,3	20	6	13,3	HKS-M8x45-W55	25
			1.94	1.77	.17	.79	.24	.52		
3D	3	M8	59,3	55	4,3	20	6	13,3	HKS-M8x55-W55	25
			2.33	2.17	.17	.79	.24	.52		

Suitability Chart for ACT Hammerhead Bolts in the Twin Series

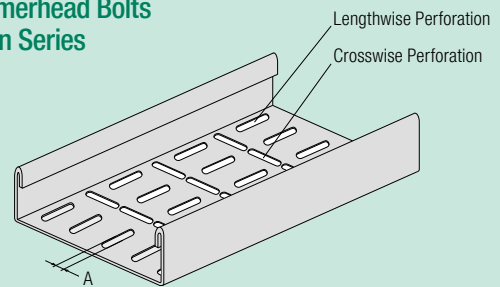

ACT Hammerhead Bolts are suitable for field trays and cable ladders with diagonal, lengthwise and/or crosswise slots and perforations that meet the following requirements:

- Dimension A:** 6,2 mm ... 7,0 mm / .24 in28 in (Min ... Max)

In case of doubt, please do not hesitate to contact STAUFF prior to field application.





ACT Mounting Hardware Multi-Level Installation (with Stacking & Hammerhead Bolts)

Required components (for a recommended maximum of two levels in total):

- 1 ACT Self-Locking Nut MUS-HKS ... W55
- 1 ACT Cover Plate GD ... W55
- 1 ACT Clamp Body (2 Clamp Halves)
- 1 ACT Stacking Bolt AF-HSK...W55
- 1 ACT Safety Locking Plate SIV...ACT
- 1 ACT Clamp Body (2 Clamp Halves)
- 1 ACT Hammerhead Bolt HSKS ... W55

Material Code
W55

ACT Mounting Hardware Material Properties and Handling Instructions

ACT Mounting Hardware is made of Stainless Steel V4A (Material Code: W55) with enhanced corrosion resistance by practically excluding metallic and non-metallic impurities during production, processing and handling.

ACT Mounting Hardware is always delivered in hermetically-sealed quality storage bags with 25 pieces each to avoid contamination during transport.

Always make sure that ACT Mounting Hardware is stored separately from carbon steel and any other metals, and that appropriate tools are used to assemble the clamps.

Details: www.stauff.com/act/assembly

All-Metal Self-Locking ACT Nut Type MUS-HKS ... W55 (similar to DIN 980 / Biloc)

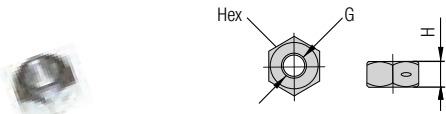

For use with ACT Stacking Bolts AF-HKS ... W55

Group STAUFF	DIN	Dimensions (mm/in)	Hex	Ordering Code	Packaging Unit (in pieces / bag)
		Thread G	H		
1D	1	M6	5	MUS-HKS-M6-W55	25
			.20		
2D	2	M8	6.5	MUS-HKS-M8-W55	25
			.26		
3D	3				

ACT Cover Plate Type GD ... W55

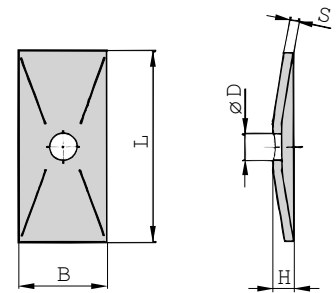

Group STAUFF	DIN	Dimensions (mm/in)	Ordering Code	Packaging Unit (in pieces / bag)				
		L	B	H	S	ØD		
1D	1	34	30	7	3	7	GD-1D-W55	25
		1.34	1.18	.28	.12	.28		
2D	2	52	30	7	3	9	GD-2D-W55	25
		2.05	1.18	.28	.12	.35		
3D	3	65	30	7	3	9	GD-3D-W55	25
		2.56	1.18	.28	.12	.35		

ACT Stacking Bolt Type AF-HSK ... W55



For use with Self-Locking ACT Nuts MUS-HKS ... W55

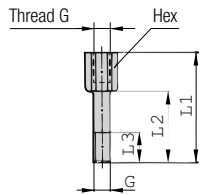

Group STAUFF	DIN	Dimensions (mm/in)	Order Code	Packaging Unit (in pieces / bag)				
		G	L1	L2	L3 min.	Hex		
1D	1	M6	49	35	12	11	AF-HSK-1D-M-W55	25
			1.93	1.38	.47	.43		
2D	2	M8	50	37	11	12	AF-HSK-2D-M-W55	25
			1.97	1.47	.43	.47		
3D	3	M8	61	46	15	12	AF-HSK-3D-M-W55	25
			2.40	1.81	.59	.47		

ACT Safety Locking Plate Type SIV ... ACT



Made of flame-retardant PP-V0 plastic material; tested and V0 classified according to UL 94

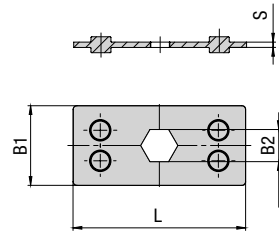

Group STAUFF	DIN	Dimensions (mm/in)	Order Code	Packaging Unit (in pieces / bag)			
		L	B1	B2	S		
1D	1	34	30	11,2	2	SIV-1D-PP-V0-ACT	25
		1.39	1.18	.44	.08		
2D	2	52	30	12,1	2	SIV-2D-PP-V0-ACT	25
		2.05	1.18	.48	.08		
3D	3	65	30	12,1	2	SIV-3D-PP-V0-ACT	25
		2.56	1.18	.48	.08		

ACT Hammerhead Bolt Type HSKS ... W55

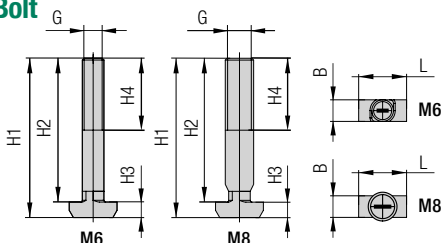

Group STAUFF	DIN	Dimensions (mm/in)	Ordering Code	Packaging Unit (in pcs. / bag)						
		G	H1	H2	H3	H4 min	B	L		
1D	1	M6	29,3	25	4,3	20	6,1	13,3	HSKS-M6x25-W55	25
			1.15	.98	.17	.79	.24	.52		
2D	2	M8	32,3	28	4,3	20	6	13,3	HSKS-M8x28-W55	25
			1.27	1.10	.17	.79	.24	.52		
3D	3	M8	42,3	38	4,3	20	6	13,3	HSKS-M8x38-W55	25
			1.67	1.50	.17	.79	.24	.52		



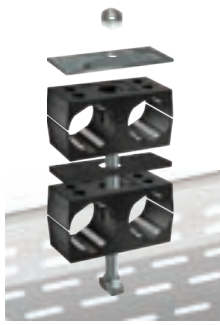

ACT Mounting Hardware Multi-Level Installation in Field Trays / Cable Ladders (with Hammerhead Bolts)

Required components (for a recommended maximum of two levels in total):

- 1 ACT Self-Locking Nut MUS-HKS ... W55
- 1 ACT Cover Plate GD ... W55
- 1 ACT Clamp Body (2 Clamp Halves)
- 1 ACT Safety Locking Plate SIV-ACT
- 1 ACT Clamp Body (2 Clamp Halves)
- 1 ACT Hammerhead Bolt HKSV ... W55

Material Code W55 **ACT Mounting Hardware**
Material Properties and Handling Instructions

ACT Mounting Hardware is made of Stainless Steel V4A (Material Code: W55) with enhanced corrosion resistance by practically excluding metallic and non-metallic impurities during production, processing and handling.

ACT Mounting Hardware is always delivered in hermetically-sealed quality storage bags with 25 pieces each to avoid contamination during transport.

Always make sure that ACT Mounting Hardware is stored separately from carbon steel and any other metals, and that appropriate tools are used to assemble the clamps.
Details: www.stauff.com/act/assembly

All-Metal Self-Locking ACT Nut Type MUS-HKS ... W55 (similar to DIN 980 / Biloc)

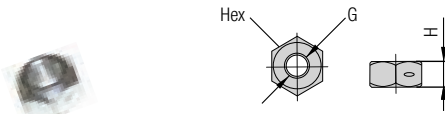

For use with ACT Hammerhead Bolts HKS ... W55

Group STAUFF	DIN	Dimensions (mm/in)	Ordering Code	Packaging Unit (in pieces / bag)		
		Thread G	H	Hex		
1D	1	M6	5 .20	10 .39	MUS-HKS-M6-W55	25
2D	2	M8	6.5 .26	13 .51	MUS-HKS-M8-W55	25
3D	3					

ACT Cover Plate Type GD ... W55

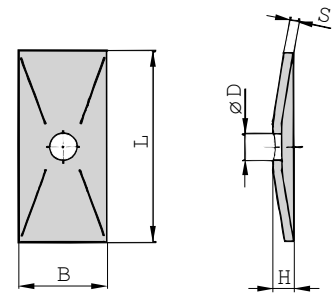

Group STAUFF	DIN	Dimensions (mm/in)	Ordering Code	Packaging Unit (in pieces / bag)				
		L	B	H	S	ØD		
1D	1	34	30	7	3	7	GD-1D-W55	25
		1.34	1.18	.28	.12	.28		
2D	2	52	30	7	3	9	GD-2D-W55	25
		2.05	1.18	.28	.12	.35		
3D	3	65	30	7	3	9	GD-3D-W55	25
		2.56	1.18	.28	.12	.35		

ACT Hammerhead Bolt Type HKSV ... W55

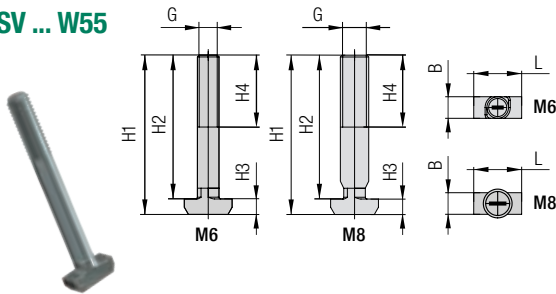

For use with Self-Locking ACT Nuts MUS-HKS ... W55

Group STAUFF	DIN	Dimensions (mm/in)	Ordering Code	Packaging Unit (in pcs. / bag)						
		G	H1	H2	H3	H4 min	B	L		
1D	1	M6	76,3	72	4,3	20	6,1	13,3	HKSV-M6x72-W55	25
			3.00	2.83	.17	.79	.24	.52		
2D	2	M8	77,3	73	4,3	20	6	13,3	HKSV-M8x73-W55	25
			3.04	2.87	.17	.79	.24	.52		
3D	3	M8	97,3	93	4,3	20	6	13,3	HKSV-M8x93-W55	25
			3.83	3.66	.17	.79	.24	.52		

ACT Safety Locking Plate Type SIV ... ACT

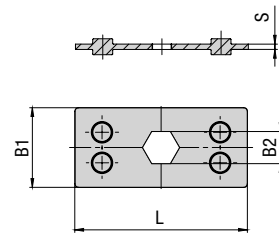

Made of flame-retardant PP-V0 plastic material; tested and V0 classified according to UL 94

Group STAUFF	DIN	Dimensions (mm/in)	Order Code	Packaging Unit (in pieces / bag)			
		L	B1	B2	S		
1D	1	34	30	11,2	2	SIV-1D-PP-V0-ACT	25
		1.39	1.18	.44	.08		
2D	2	52	30	12,1	2	SIV-2D-PP-V0-ACT	25
		2.05	1.18	.48	.08		
3D	3	65	30	12,1	2	SIV-3D-PP-V0-ACT	25
		2.56	1.18	.48	.08		



Installation on Weld Plate
Required components:

- 1 Hexagon Head Bolt AS...W55
- 1 Cover Plate GD...W55
- 1 ACT Clamp Body (2 Clamp Halves)
- 1 Single Weld Plate SP...W55

Before welding, always make sure that the designated position of the weld plate is suitable for the expected loads.

Order Code
SP-110/10-ACT-GD-AS-M-W55

W55 is the recommended option for metal hardware to be used with STAUFF ACT Clamps.

Multi-Level Installation (with Weld Plate)
Required components (for each level)
for a maximum of two levels in total:

- 1 Stacking Bolt AF...W55
- 1 Safety Locking Plate SIG...W55
- 1 ACT Clamp Body (2 Clamp Halves)

The upper layer has to be secured by a cover plate and hexagon head bolts. The lower level has to be mounted to a weld plate.

Order Code
110/10-ACT-SIV-ACT-AF-M-W55

W55 is the recommended option for metal hardware to be used with STAUFF ACT Clamps.

Installation with Channel Rail Adaptors
Required components:

- 1 Hexagon Head Bolt AS...W55
- 1 Cover Plate GD...W55
- 1 ACT Clamp Body (2 Clamp Halves)
- 1 Channel Rail Adaptor CRA...W55

Suitable for various brands and types of channel rails (including Halfen, Hiiti, Unistrut® etc.).

Order Code
CRA-110/10-ACT-GD-AS-M-W55

W55 is the recommended option for metal hardware to be used with STAUFF ACT Clamps.

Installation in Field Trays / Cable Ladders
Required components:

- 1 Self-Locking Nut MUS-HKS ... W55
- 1 Cover Plate GD ... W55
- 1 ACT Clamp Body (2 Clamp Halves)
- 1 Hammerhead Bolt HKS ... W55

Suitable for commonly used field trays and cable ladders with diagonal, lengthwise and/or crosswise slots and perforations.

Order Code
HKS-110/10-ACT-GD-MUS-M-W55

W55 is the recommended option for metal hardware to be used with STAUFF ACT Clamps.

**Multi-Level Installation
in Field Trays / Cable Ladders**
Required components
(for a maximum of two levels in total):

- 1 Self-Locking Nut MUS-HKS ... W55
- 1 Cover Plate GD ... W55
- 1 ACT Clamp Body (2 Clamp Halves)
- 1 Stacking Bolt AF-HKSK...W55
- 1 Safety Locking Plate SIV...ACT
- 1 ACT Clamp Body (2 Clamp Halves)
- 1 Hammerhead Bolt HKSK ... W55

Suitable for commonly used field trays and cable ladders with diagonal, lengthwise and/or crosswise slots and perforations.

Order Codes

Upper Level: **HKSK-212.7/12.7-ACT-GD-MUS-M-W55**
Lower Level: **212.7/12.7-ACT-SIV-ACT-AF-HKSK-M-W55**

W55 is the recommended option for metal hardware to be used with STAUFF ACT Clamps.

**Multi-Level Installation
in Field Trays / Cable Ladders**
Required components
(for a maximum of two levels in total):

- 1 Self-Locking Nut MUS-HKS ... W55
- 1 Cover Plate GD ... W55
- 1 ACT Clamp Body (2 Clamp Halves)
- 1 Safety Locking Plate SIV-ACT
- 1 ACT Clamp Body (2 Clamp Halves)
- 1 Hammerhead Bolt HKSV ... W55

Suitable for commonly used field trays and cable ladders with diagonal, lengthwise and/or crosswise slots and perforations.









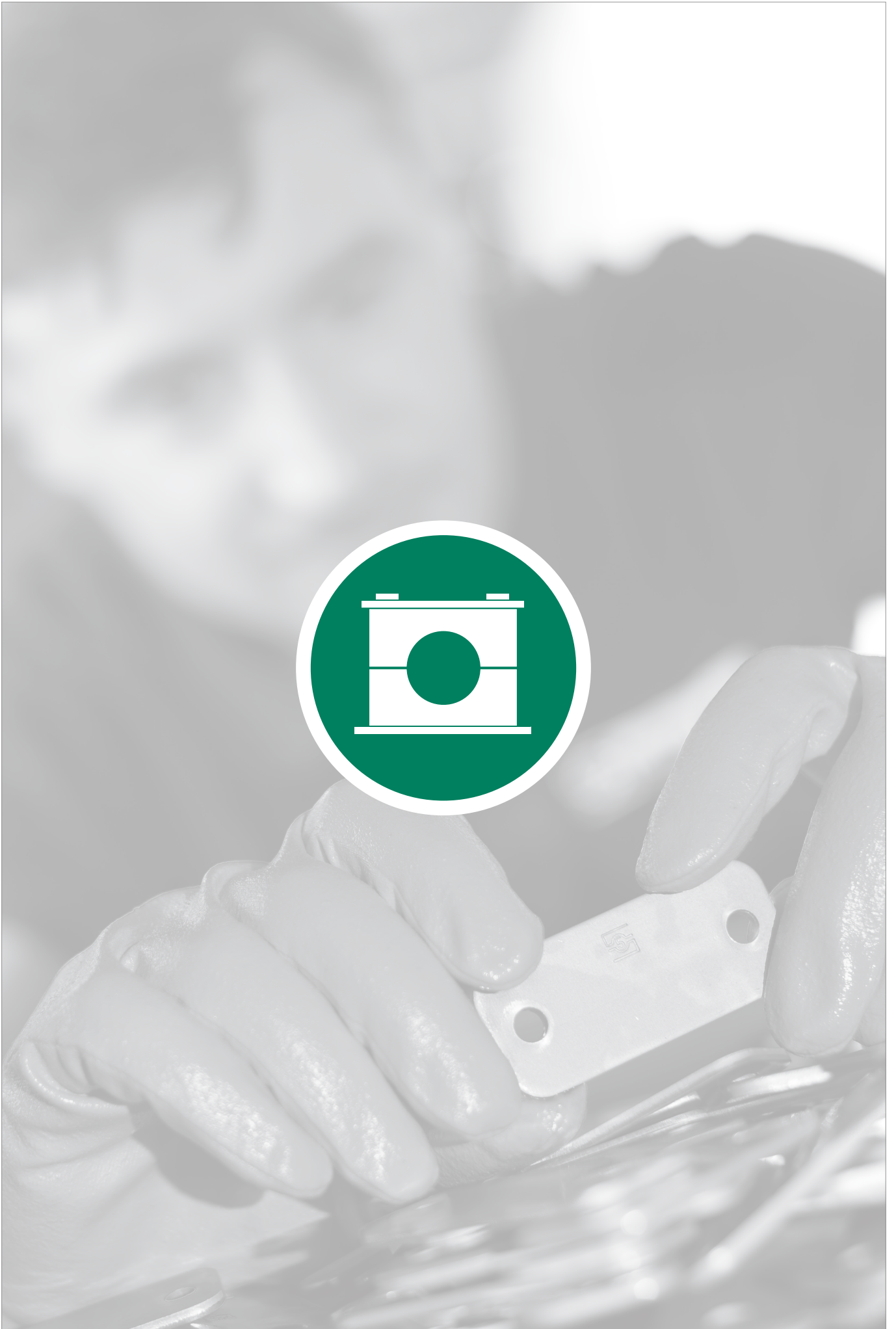



Order Codes

Upper Level: **HKSV-212.7/12.7-ACT-GD-MUS-M-W55**
Lower Level: **212.7/12.7-ACT-SIV-ACT**

W55 is the recommended option for metal hardware to be used with STAUFF ACT Clamps.

E

	Introduction	92
	Weld Stud with Female Thread SWG-SF	92
	Distance Plate for DIN 3015 Clamps SWG-DIP	93
	Cable Tie Holder SWG-CTH-11-M6	93
	Cable Tie / Tension Belt Holder SWG-CTH-30-M6-1	93
	Cable Tie / Tension Belt Holder SWG-CTH-30-M6-2	93
	Starterkit SWG-WI06-Starterkit	94
	Weld Inverter SWG-WI06	94
	Weld Gun - Arc Ignition SWG-WG	94
	Distance Adaptor SWG-AGS	95
	Distance Tube DIT-SR6-SWG	95
	Stud Retainer SWG-SR6	95
	Ground Cable SWG-GC	95



STAUFF SWG Stud Welding System

In many areas, stud welding is considered to be the most economic fastening method for components and is sometimes even the only technically feasible solution. Because the stud is joined with the substructure over the entire surface of the stud, a high strength of the joint can be achieved.

STAUFF is now using this proven principle for the installation of pipe, tube, hose and cable clamps in the Standard Series (according to DIN 3015, part 1) as well as in the Twin Series (according to DIN 3015, part 3) with M6 mounting thread, where female threaded weld studs replace the regular weld plates; distance plates made from plastic provide the necessary spacing between the clamp bodies and the substructure.

If required, the system can also be adopted for alternative fastening methods, e.g. for clamping belts, cable ties or conduit hoses.

In addition to the individual components – weld studs, distance plates, clamp bodies and metal hardware required – STAUFF also provides the correspondingly designed assembly tools such as the weld inverter and the weld gun with distance tube, stud retainer and distance adaptor for DIN 3015 clamps. The lightweight and compact weld inverter works without high-voltage current.

Thanks to increased productivity and flexibility for the installation of clamps, the system offers considerable savings potentials for users with significant processing volumes, especially when working in horizontal or overhead position. The amount of rework on welding locations can be significantly decreased, and material distortion is reduced to a minimum through low thermal stress.

The joint of the weld stud with the substructure impresses in particular with a high degree of strength and safety, which is at least at the same level as for regular weld plates.

- Developed and optimised to the functions of original STAUFF Clamps in the Standard Series (DIN 3015, Part 1)
- Versatile combination and adaptation options available (e.g. fastening elements for conduit hoses, clamping belts and cable ties)
- All installation options are fully covered by only one weld stud
- Significant time and cost savings by a quicker welding process and reduced rework on welding locations
- Material distortion reduced to a minimum through low thermal stress (particularly significant when handling thin metal sheets)
- High degree of safety and protection against corrosion due to a welded joint over the whole surface
- Lightweight and compact designed welding inverter
- By default no shielding gas or ceramic ferrule required
- Works without high-voltage current

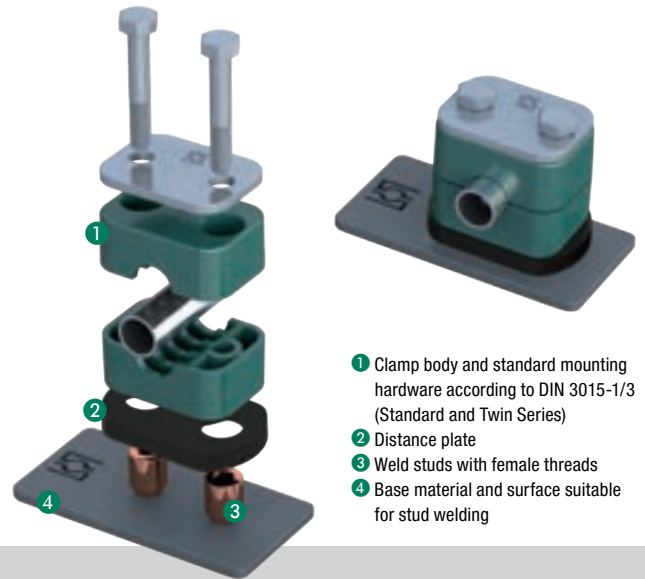

- 1 Clamp body and standard mounting hardware according to DIN 3015-1/3 (Standard and Twin Series)
- 2 Distance plate
- 3 Weld studs with female threads
- 4 Base material and surface suitable for stud welding

Assembly using weld plates
100%

Reduction of the assembly time per clamp*

Assembly using the stud welding system
23%

*For a typical assembly procedure in production environments.

Weld Stud with Female Thread Type SWG-SF

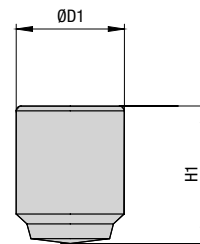

Ordering Codes			
Weld Stud	*SWG-SF-*M6x11x14-*W124		
* Weld Stud with Female Thread	SWG-SF		
* Thread code	Metric ISO thread	M6x11x14	
	Unified coarse (UNC) thread	UNC1/4-20x11x14	
* Material code	Steel 4.8 with galvanised copper coating C1E (DIN EN ISO 4042)	W124	

Group	STAUFF	DIN	Dimensions (mm/in)			Order Codes (Standard Options)	Packaging Units (in pcs. / per bag)
			Thread G	ØD1	H1		
1 ... 8		0 ... 8	M6	11	14	SWG-SF-M6x11x14-W124	100
				.43	.55		
			1/4-20 UNC	11	14	SWG-SF-UNC1/4-20x11x14-W124	
				.43	.55		

Alternative materials are available upon request. Please contact STAUFF for further information.

Maximum torque rating: 6 N-m / 4.43 ft-lb. Specific series can further limit the torque rating. The maximum loads in pipe direction listed on page 161 reduce accordingly. In case of doubt, please contact STAUFF in advance.

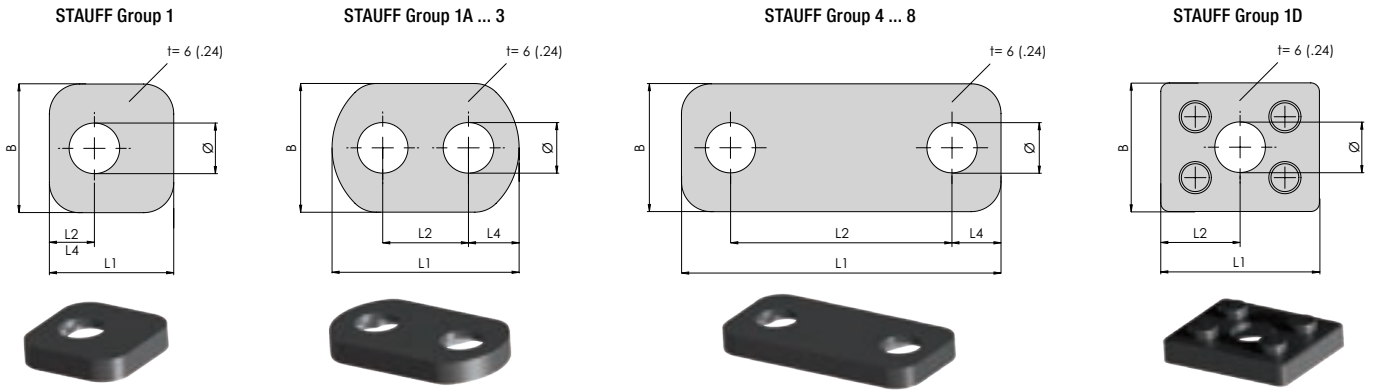

**Distance Plate for DIN 3015 Clamps
Type SWG-DIP**

Group STAUFF	DIN	Pipe/Tube-Ø (mm/in)	Dimensions (mm/in)					Order Codes (Standard Options)	Packaging Units (in pcs. / per bag)
		Clamp Body	L1	L2*	L4	B	Ø		
1	0	6 ... 12	29	10,5	10,5	30	11,8	SWG-DIP-1-PP-BK	25
		.2448	1.14	.41	.41	1.18	.46		
1A	1	6 ... 12	43,5	20	11,8	30	11,8	SWG-DIP-1A-PP-BK	25
		.2448	1.71	.79	.46	1.18	.46		
2	2	12,7 ... 18	48,5	26	11,3	30	11,8	SWG-DIP-2-PP-BK	25
		.5071	1.90	1.02	.44	1.18	.46		
3	3	19 ... 25,4	56,5	33	11,8	30	11,8	SWG-DIP-3-PP-BK	25
		.75 ... 1.00	2.22	1.30	.46	1.18	.46		
4	4	26,9 ... 32	62	40	11	30	11,8	SWG-DIP-4-PP-BK	25
		1.06 ... 1.26	2.44	1.57	.43	1.18	.46		
5	5	32 ... 42	75	52	11,5	30	11,8	SWG-DIP-5-PP-BK	25
		1.26 ... 1.65	2.95	2.05	.45	1.18	.46		
6	6	44,5 ... 54	88	66	11	30	11,8	SWG-DIP-6-PP-BK	25
		1.75 ... 2.12	3.46	2.60	.43	1.18	.46		
7	7	57,2 ... 76,1	121	94	13,5	30	11,8	SWG-DIP-7-PP-BK	10
		2.25 ... 3.00	4.76	3.70	.53	1.18	.46		
8	8	88,9 ... 102	147	120	13,5	30	11,8	SWG-DIP-8-PP-BK	10
		3.50 ... 4.00	5.78	4.72	.53	1.18	.46		
1D	1	6 ... 12	37	18,5	-	30	11,8	SWG-DIP-1D-PP-BK	25
		.2448	1.45	.73	-	1.18	.46		

Ordering Codes
Distance Plate
***SWG-DIP*2*PP-BK**

* Distance Plate

SWG-DIP

* STAUFF Group

2

 * Material code Polypropylene (Colour: Black) **PP-BK**

Alternative materials are available upon request. Please contact STAUFF for further information.

* ±0,1(.003)

Material: Polyamide (reinforced)

Suitable for hexagon socket button cap screws M6x12 (ISO 7380-1)

Standard packaging unit: 25 pcs.

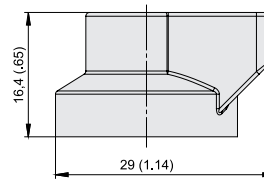
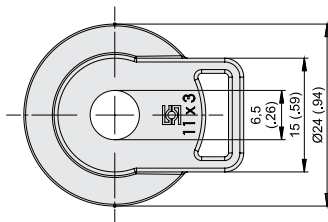
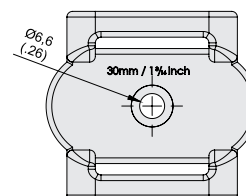
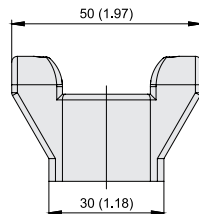
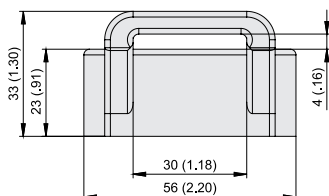

**Cable Tie Holder
Type SWG-CTH-11-M6**

Material: Polyamide (reinforced)

Suitable for socket cap screws M6x12 (ISO 4762) or hexagon socket button cap screws M6x12 (ISO 7380-1)

Standard packaging unit: 25 pcs.

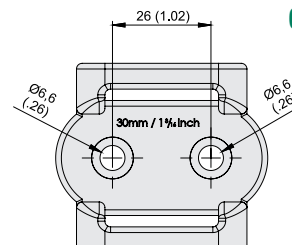
Dimensional drawings: All dimensions in mm (in).

**Cable Tie / Tension Belt Holder
Type SWG-CTH-30-M6-1**

**Cable Tie / Tension Belt Holder
Type SWG-CTH-30-M6-2**

Starterkit Type SWG-WI06-Starterkit



Starterkit including:

- 1 Weld Inverter **SWG-WI06**
- 1 Weld Gun **SWG-WG**
- 1 Ground Cable **SWG-GC**
- 1 Distance Tube **DIT-SR6-SWG-WG30**
(for STAUFF Groups 2 to 8)
- 5 Stud Retainer **SWG-SR6**
- 1 Toolkit (Box Spanner/Hex Wrench)
- Operating Manual (English / German)

Required Accessories:

- Distance Adaptor **SWG-AGS-...** for DIN 3015 Clamps
- Weld Stud **SWG-SF**
- Distance Tube **DIT-SR6-SWG-WG25**
(for STAUFF Group 1A, if required)

Weld Inverter Type SWG-WI06

F



Characteristics

- Works without high-voltage current
- No heavy extension cords required
- Extremely powerful and robust
- Compact in design
- Lightweight with only 18 kg / 40 lbs
- Welding current: 100 ... 650 A (stepless control)
- Welding time: 5 ... 200 ms (stepless control)
- Connection Cable: 3 m / 9.84 ft

Required Accessories

- Weld Gun **SWG-WG** and Accessories
- Ground Cable **SWG-GC**

Technical Data

Primary Power

- 100 V to 240 V, 1 phase, 50/60 Hz, 16 AT

Primary Plug

- 16 A 2-pin grounded safety plug (plug type F CEE 7/4)

IP Code

- IP 44 (also permits operation outdoors)

Ambient Temperature Limits

- ±0 °C ... +40 °C / +32 °F ... +104 °F

Dimensions (L x W x H)

- 474 x 337 x 351 mm / 18.66 x 13.27 x 13.82 in

Weld Gun - Arc Ignition Type SWG-WG

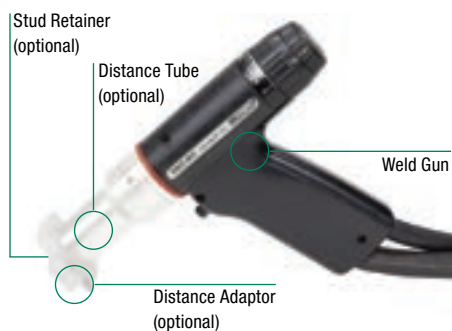

Characteristics

- Compact in design
- Lightweight with only 0,8 kg / 1.8 lbs (without cable)
- Ergonomic handle
- Comfortable setup
- Connection Cable: 5 m / 16.40 ft

Required Accessories

- Distance Adaptor **SWG-AGS-...** for DIN 3015 Clamps
- Distance Tube **DIT-SR6-SWG-WG30** (for STAUFF Groups 2 to 8)
- Distance Tube **DIT-SR6-SWG-WG25** (for STAUFF Group 1A)
- Stud Retainer **SWG-SR6**

Technical Data

Lift

- Adjustment range 3 mm / .11 in, lockable

Workplace noise level

- Up to 90 dB (A) may occur during welding

Dimensions (L x W x H)

- 200 x 65 x 140 mm / 7.87 x 2.56 x 5.51 in
(without cable, without distance tube)



**Distance Adaptor
Type SWG-AGS**

Group STAUFF	DIN	for use with	Ordering Codes
1	0	Distance Tube Type A	NO DISTANCE ADAPTOR REQUIRED
1A	1	Distance Tube Type A	SWG-AGS-1A
2	2	Distance Tube Type B	SWG-AGS-2
3	3	Distance Tube Type B	SWG-AGS-3
4	4	Distance Tube Type B	SWG-AGS-4
5	5	Distance Tube Type B	SWG-AGS-5
6	6	Distance Tube Type B	SWG-AGS-6
7	7	Distance Tube Type B	SWG-AGS-7
8	8	Distance Tube Type B	SWG-AGS-8
1D	1D	Distance Tube Type A	NO DISTANCE ADAPTOR REQUIRED

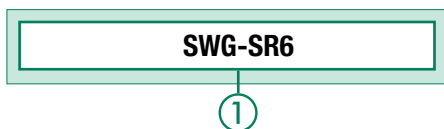

**Distance Tube
Type DIT-SR6-SWG**

Type	for use with	Ordering Codes
A	Distance Adaptor SWG-AGS-1A	DIT-SR6-SWG-WG25
B	Distance Adaptor SWG-AGS-2...8	DIT-SR6-SWG-WG30

F
**Stud Retainer
Type SWG-SR6**
Order Code

① Type

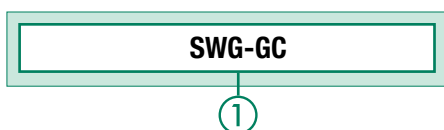
 Stud Retainer **SWG-SR6**

Standard packaging unit: 5 pcs.



Order Code

① Type

 Ground Cable **SWG-GC**
Characteristics

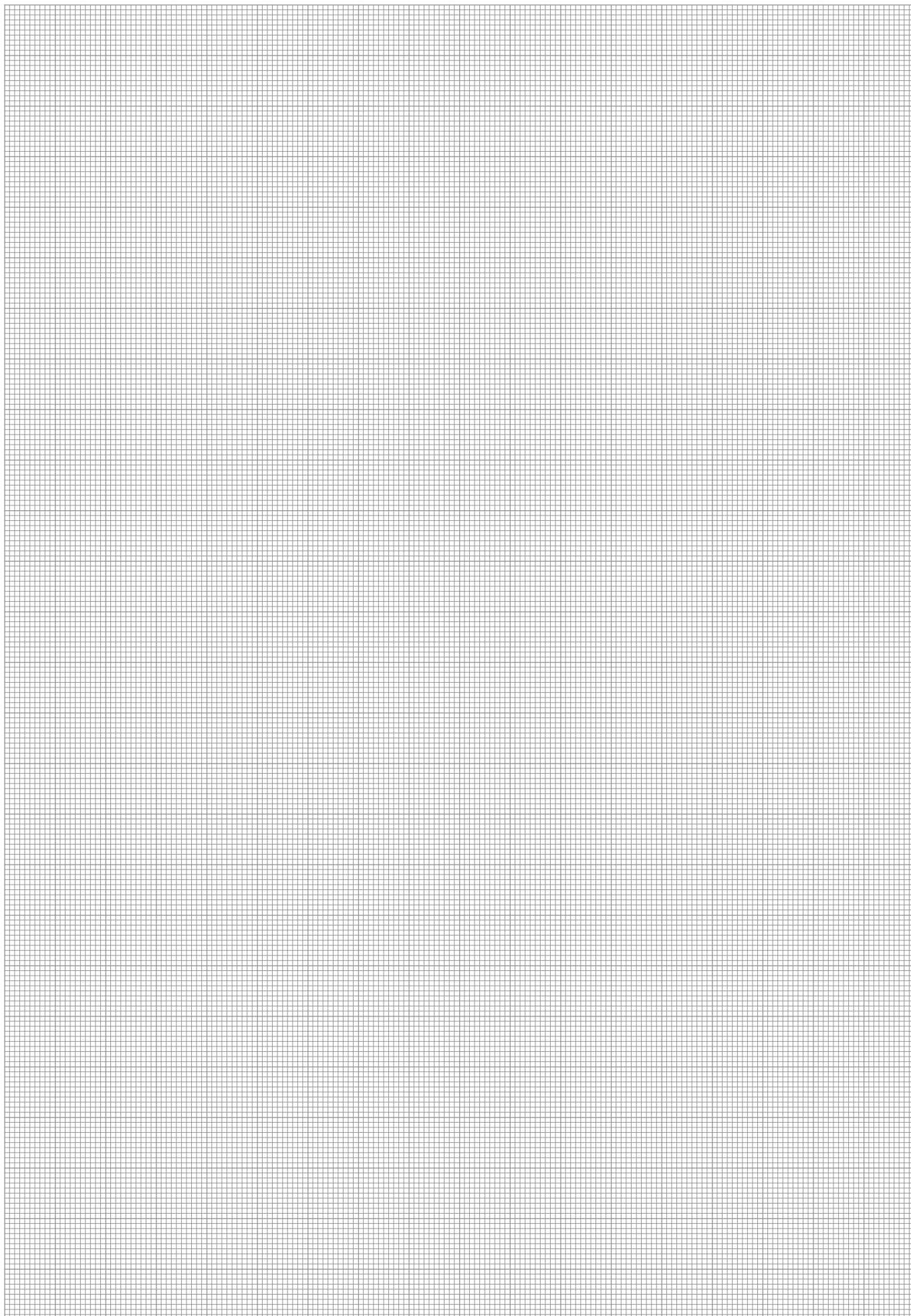
- Cable length: 5 m / 16.40 ft
- Equipped with 2 vice grips 10"

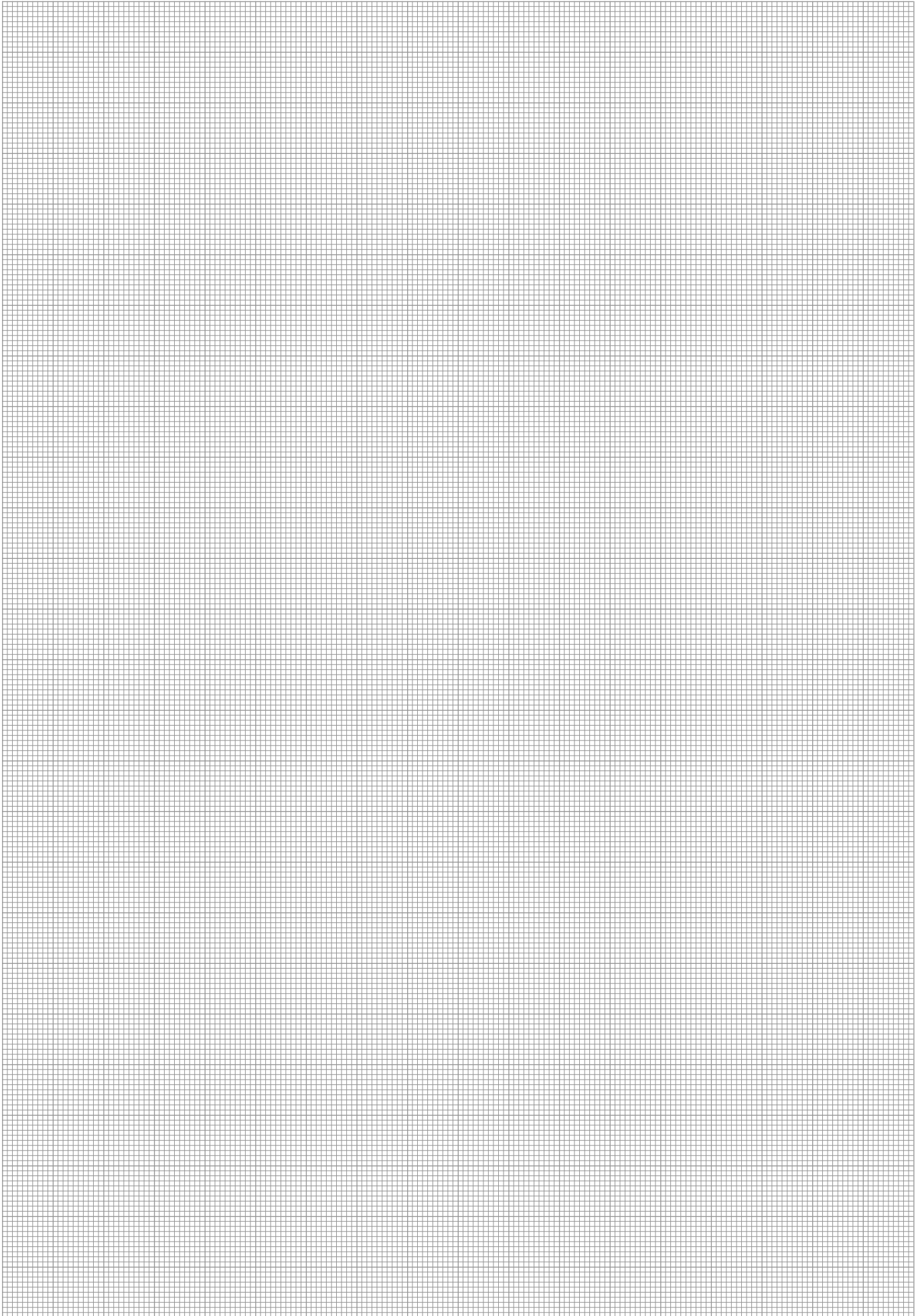
**Ground Cable
Type SWG-GC**



G



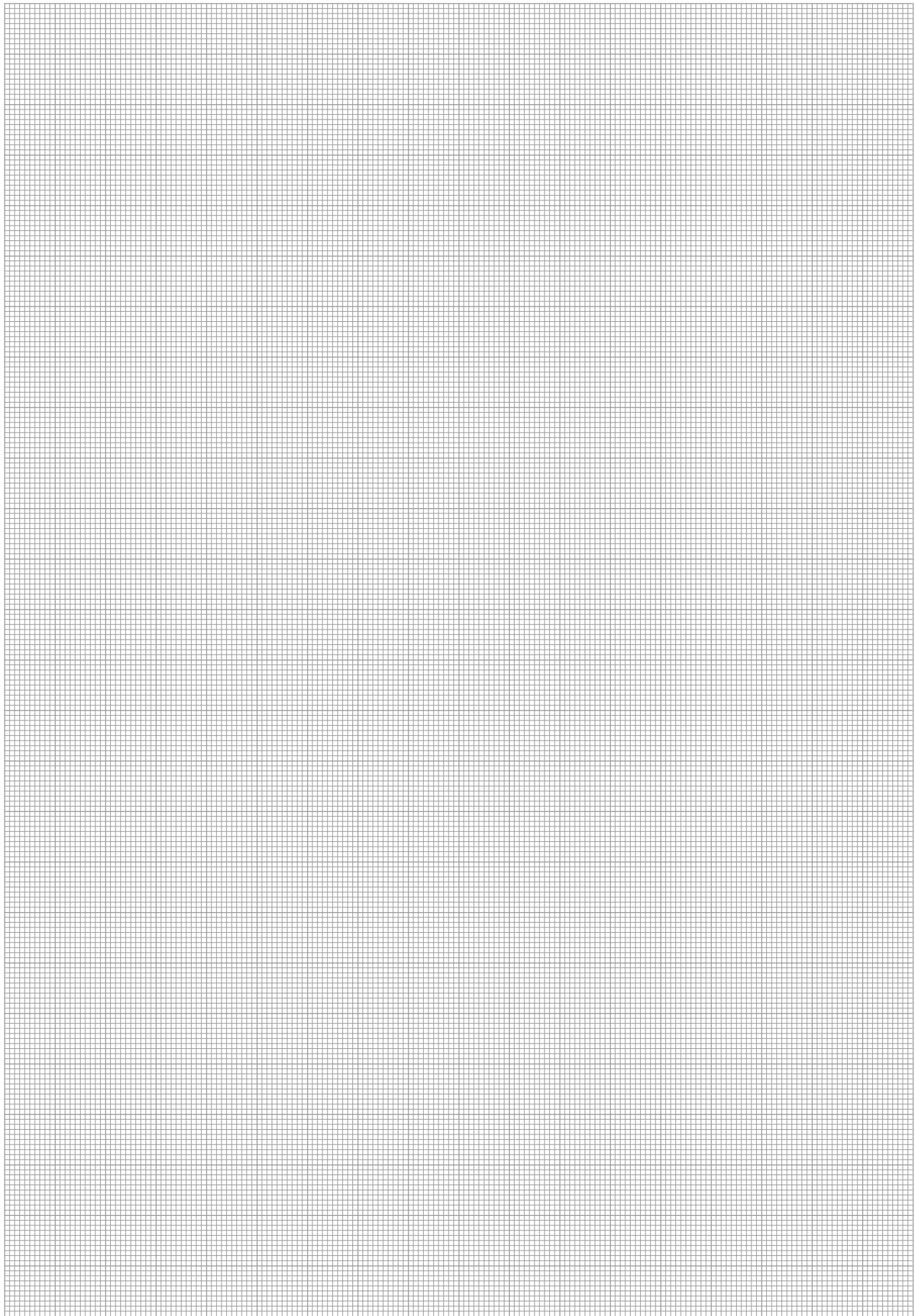

G



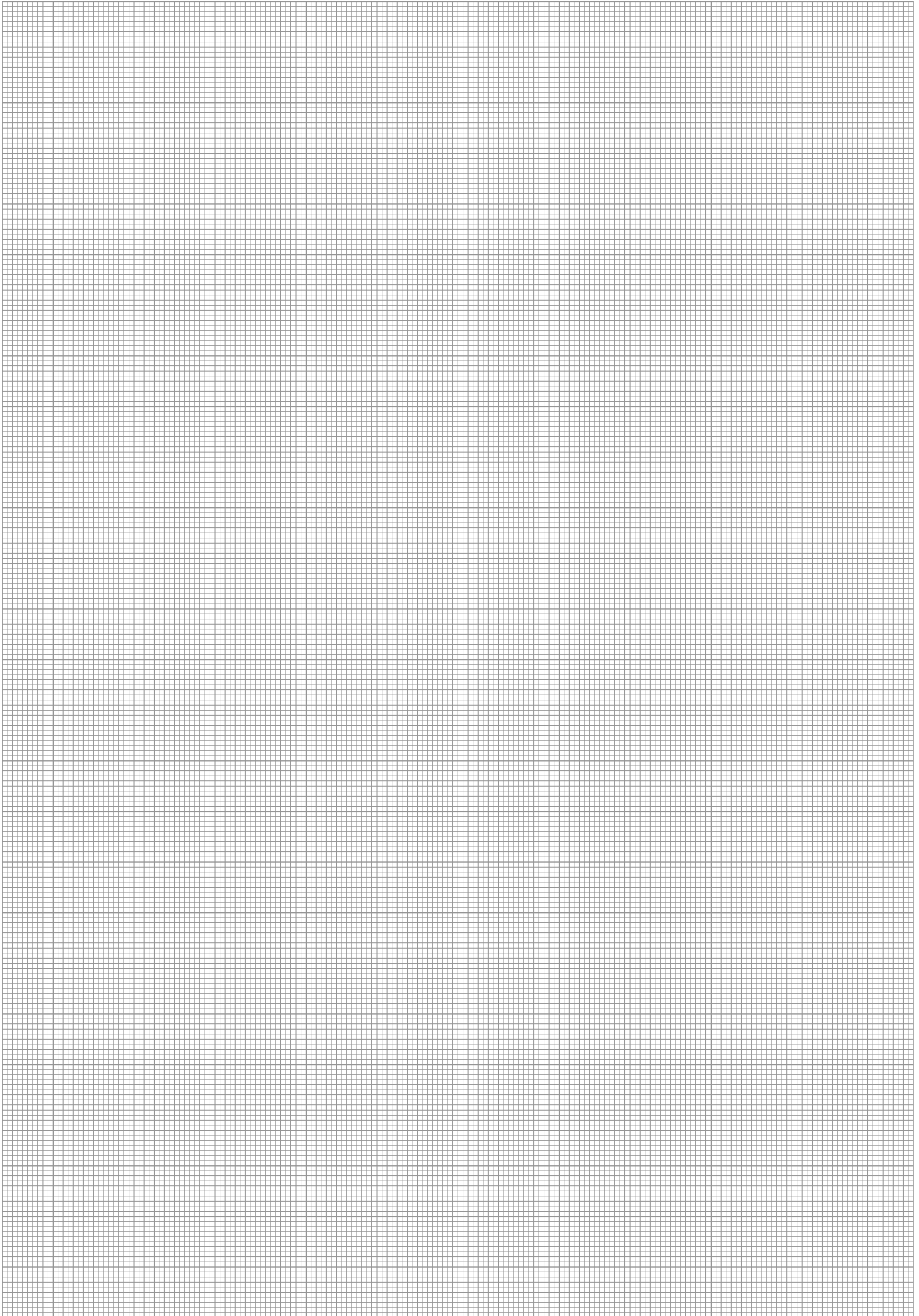

G



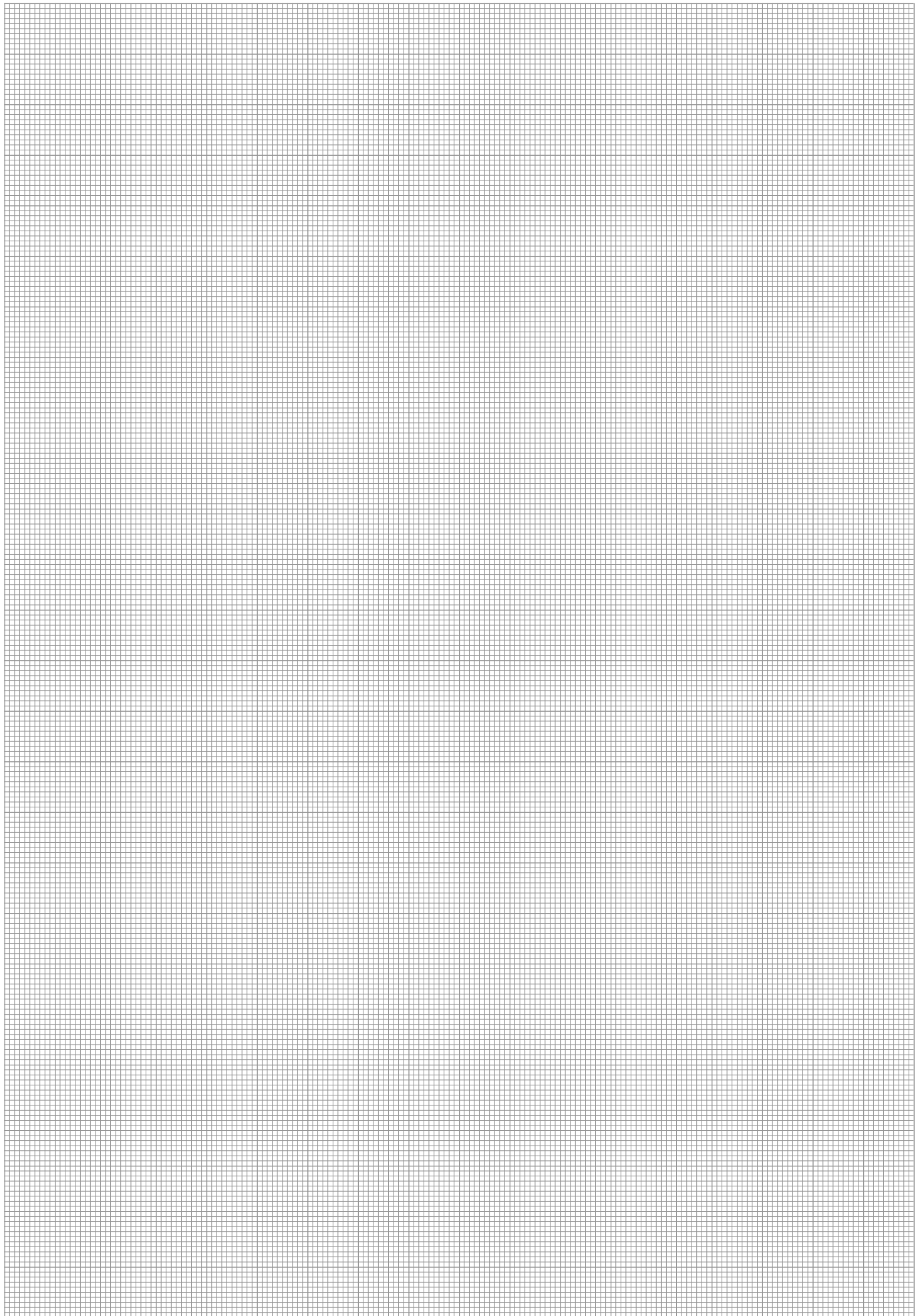

G



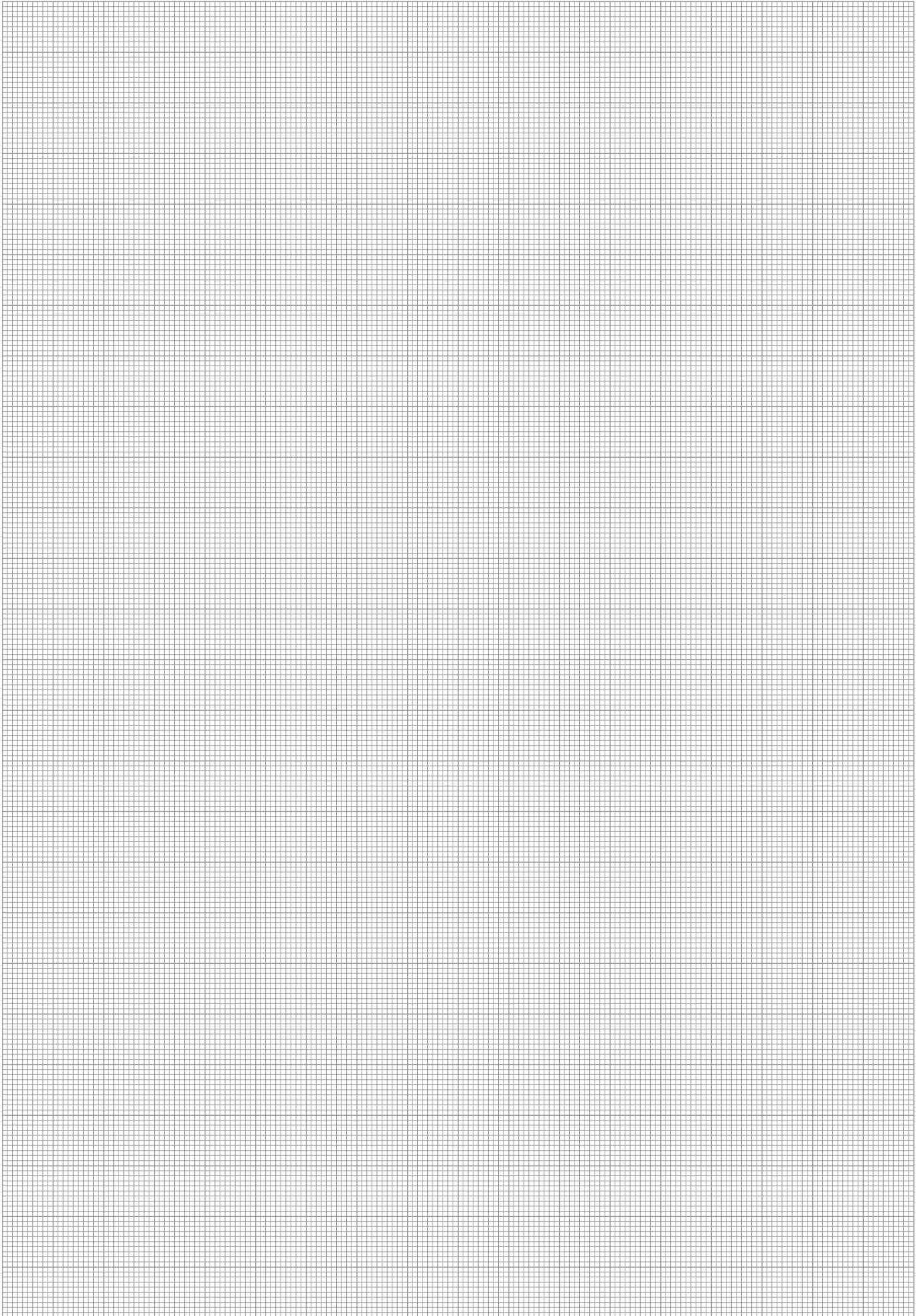

G







Machined Versions

104



Injection Moulded Version

106



Metal Versions and Accessories

107

Enquiry Form for Custom-Designed Special Clamps

108



Machined Versions

Custom-designed clamping systems for pipes, tubes, hoses, cables and other components according to customer's specifications or based on STAUFF developments, made of thermoplastics, metals and non-ferrous metals.

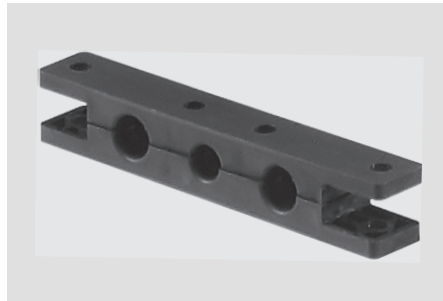

H



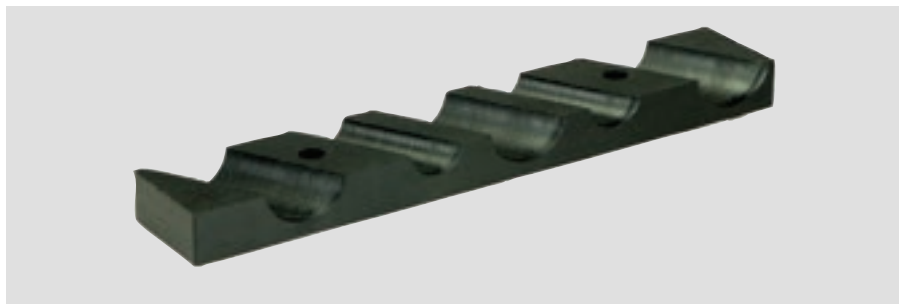

H



Injection Moulded Versions (Flexi Clamps)

Custom-designed clamping systems for pipes, tubes, hoses, cables and other components according to customer's specifications or based on STAUFF developments, made of Polypropylene, Polyamide and other thermoplastics.



Photo Source: mm-fotowerbung.de

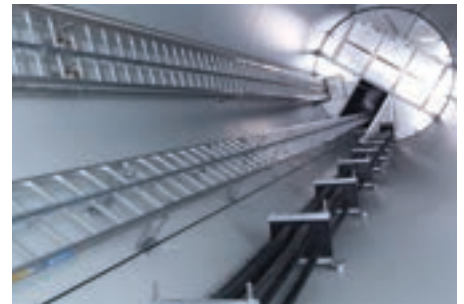
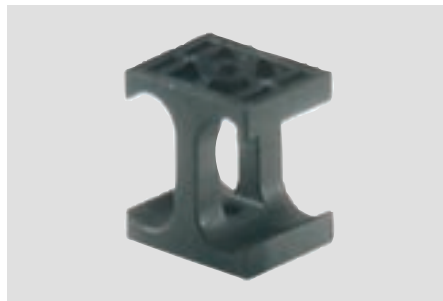
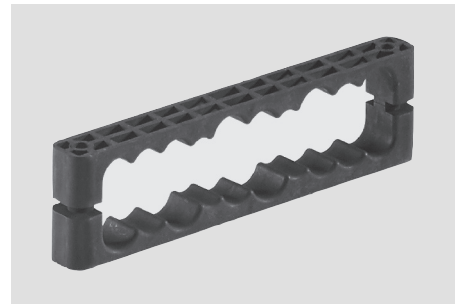
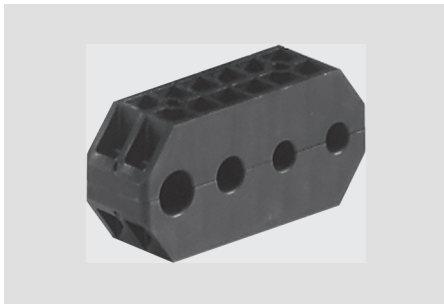

Photo Source: mm-fotowerbung.de



H





Metal Versions and Accessories

Metal versions of custom-designed clamping systems for pipes, tubes, hoses, cables and other components as well as accessories such as weld plates, cover plates, bolts as well as elastomer inserts.

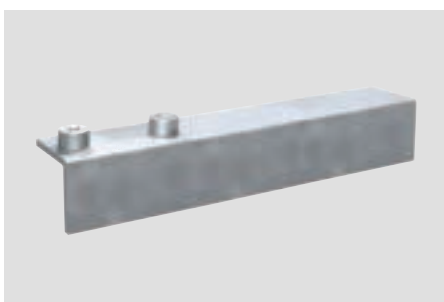

H



Enquiry Form for Custom-Designed Special Clamps

Please use the following form as a guideline when preparing an enquiry for a custom-designed special clamp. Scan or copy the page from the catalogue, print and complete it with

as much information as possible, before sending it by email or fax to the closest STAUFF branch office. If possible, please also provide a sketch / drawing and let us know the quanti-

ties required, and if the enquiry is for a one-time or recurring demand. We look forward to hearing from you, and are always available for consultation, when required.

Application Information

Area of use Indoor Outdoor

Ambient temperature Lowest _____ °C / °F Highest _____ °C / °F

Resistance against particular media No Yes Mineral oils
 Other oils _____
 Benzine
 Weak acids
 Solvents
 Alcohols
 Seawater
 Other media _____

Fire protection requirements No Yes UL94
 BS 6853
 Other standard _____

Material preference for the clamp body Polypropylene Polyamide
 Aluminium Steel
 Stainless Steel V2A V4A Other material _____

Design Information

Type of line Pipe / tube (fixed installation) Pipe / tube (sliding installation)
 Hose Conduit Hose
 Cable Mix of different types of lines
 Other components _____

Maximum dimensions of clamp body Length _____ x Width _____ x Height _____ mm / inch

Total number of lines _____

Diameters per line

Line 1 _____ <input type="checkbox"/> mm / <input type="checkbox"/> inch	Further comments _____
Line 2 _____ <input type="checkbox"/> mm / <input type="checkbox"/> inch	Further comments _____
Line 3 _____ <input type="checkbox"/> mm / <input type="checkbox"/> inch	Further comments _____
Line 4 _____ <input type="checkbox"/> mm / <input type="checkbox"/> inch	Further comments _____
Line 5 _____ <input type="checkbox"/> mm / <input type="checkbox"/> inch	Further comments _____
Line 6 _____ <input type="checkbox"/> mm / <input type="checkbox"/> inch	Further comments _____
Line 7 _____ <input type="checkbox"/> mm / <input type="checkbox"/> inch	Further comments _____
Line 8 _____ <input type="checkbox"/> mm / <input type="checkbox"/> inch	Further comments _____

Preferred centre distance of the lines _____ mm / inch

Preferred number of screw holes _____

Information on Mounting Hardware

Preferred type of bolts Hexagon head bolts (with cover plate) with metric threads with UNC threads
 Socket cap crews (with cover plate) with metric threads with UNC threads
 Socket cap crews (w/o cover plate) with metric threads with UNC threads

Preferred type of installation Welding (using a weld plate) Welding (using weld studs)
 Direct screw-fastening Adhesive bonded fastening
 Mounting rail (using a rail nut / adaptor)

Material preference for the hardware Steel Stainless Steel V2A V4A



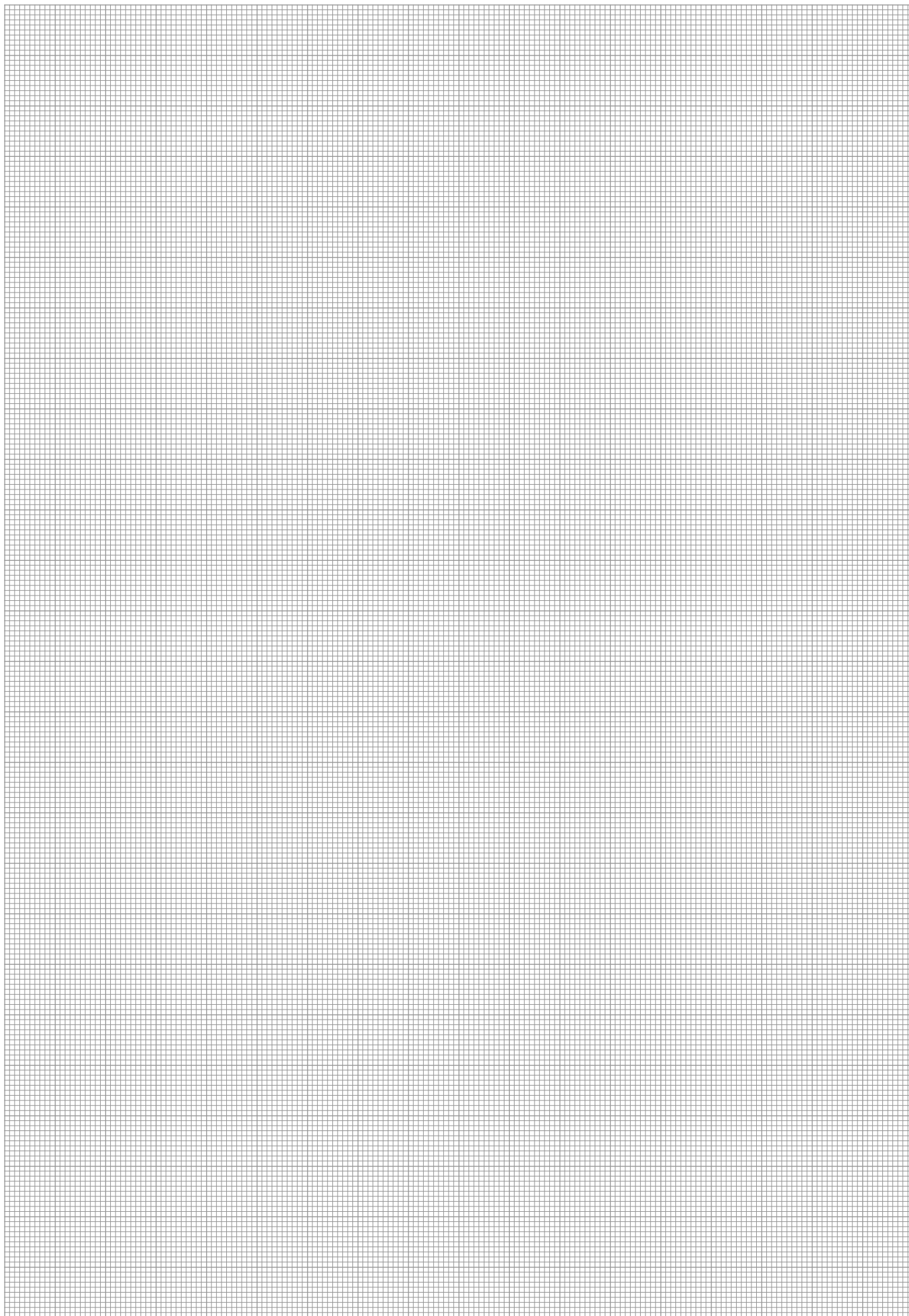











H





	Clamp Body - Single Design LBBU	112
	Clamp Body - Twin Design LBBU	113
	Weld Plate LBBU-SP	114
	Sleeve LBBU-HUE	114
	Cover Plate LBBU-DP	115
	Hexagon Head Bolt AS	115
	Clamp Body - Single Design LB	116
	Clamp Body - Twin Design LBG / LBU	117
	Clamp Body - Single Design LN	118
	Clamp Body - Twin Design LNGF / LNUF	119
	Cover Plate DPL	119



Clamp Body - Single Design Type LBBU



Size 2 in slotted design



Size 1 and 3 with film hinge

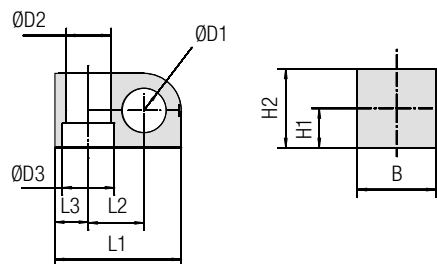

Ordering Codes

Clamp Body *LBBU-*1*06-*SA-*M8/U5/16

- * Light Series LBBU **LBBU**
- * STAUFF Group **1**
- * Exact outside diameter Ø D1 (mm) **06**
- * Material code (see below) **SA**
- * Thread code (suitable for bolts M8 and U5/16) **M8/U5/16**

Standard Materials



Thermoplastic Elastomer (87 Shore-A)
Colour: Black
Material code: **SA**

See pages 154 / 155 for material properties and technical information.

Alternative materials are available upon request. Please contact STAUFF for further information.

Product Features

- Compact and light-weight design for applications in which space is limited
- Available in 3 different sizes and covering all standard metric and imperial diameters between 4 mm and 32 mm
- Vibration-damping and noise-reducing clamp body material with UV, ozone and weathering-resistant characteristics
- Embedded metal sleeve to ensure stability of the clamp assembly

Group	Outside Diameter Pipe / Tube / Hose Ø D1		Nominal Bore Pipe (in)	Ordering Codes (1 Clamp Body)	Dimensions (mm/in)												
	(mm)	(in)			Ø D2	Ø D3	L1	L2	L3	H1	H2	B					
1	6			LBBU-106-SA-M8/U5/16													
	6,4	1/4		LBBU-106.4-SA-M8/U5/16													
	8	5/16		LBBU-108-SA-M8/U5/16													
	9,5	3/8		LBBU-109.5-SA-M8/U5/16													
	10		1/8	LBBU-110-SA-M8/U5/16	.47	.55	1.34	.59	.35	.39	.79	.79					
	11			LBBU-111-SA-M8/U5/16													
	12			LBBU-112-SA-M8/U5/16													
	12,7	1/2		LBBU-112.7-SA-M8/U5/16													
	10		1/8	LBBU-210-SA-M8/U5/16													
	11			LBBU-211-SA-M8/U5/16													
2	12			LBBU-212-SA-M8/U5/16													
	12,7	1/2		LBBU-212.7-SA-M8/U5/16													
	13,5		1/4	LBBU-213.5-SA-M8/U5/16													
	14			LBBU-214-SA-M8/U5/16	20	14	39	18	9	12	24	20					
	15			LBBU-215-SA-M8/U5/16	.47	.55	1.54	.71	.35	.47	.94	.79					
	16	5/8		LBBU-216-SA-M8/U5/16													
	17,2		3/8	LBBU-217.2-SA-M8/U5/16													
	18			LBBU-218-SA-M8/U5/16													
	19	3/4		LBBU-219-SA-M8/U5/16													
	20			LBBU-220-SA-M8/U5/16													
3	21,3			LBBU-321.3-SA-M8/U5/16													
	22	7/8		LBBU-322-SA-M8/U5/16													
	23			LBBU-323-SA-M8/U5/16													
	25			LBBU-325-SA-M8/U5/16	12	14	57,5	23,5	15	20	40	30					
	25,4	1		LBBU-325.4-SA-M8/U5/16	.47	.55	2.26	.93	.59	.79	1.57	1.18					
	28			LBBU-328-SA-M8/U5/16													
	30			LBBU-330-SA-M8/U5/16													
	32	1-1/4		LBBU-332-SA-M8/U5/16													

Additional outside diameters are available upon request. Please contact STAUFF for further information.



Type of Mounting SP (with Weld Plate LBBU-SP)

- Clamp assembly consisting of:
- 1 Hexagon Head Bolt AS
 - 1 Cover Plate LBBU-DP
 - 1 Sleeve LBBU-HUE
 - 1 Clamp Body LBBU
 - 1 Weld Plate LBBU-SP

Order Code

LBBU-SP-322-SA-DP-AS-M8-W10

W10 (Weld Plate made of Carbon Steel, phosphated; Other metal parts made of Carbon Steel, zinc/nickel-plated) is the standard option for this type of installation. For UNC threads / bolts, please replace M8 by U5/16.



Type of Mounting SM (with Hexagon Rail Nut SM-2-5D)

- Clamp assembly consisting of:
- 1 Hexagon Head Bolt AS
 - 1 Cover Plate LBBU-DP
 - 1 Sleeve LBBU-HUE
 - 1 Clamp Body LBBU
 - 1 Hexagon Rail Nut SM-2-5D (for use with Mounting Rail TS, see page 24 for details)

Order Code (Mounting Rail TS not included.)
LBBU-SM-322-SA-DP-AS-M8-W3

W3 (Metal parts made of Carbon Steel, zinc/nickel-plated) is the standard option for this type of installation. For UNC threads / bolts, please replace M8 by U5/16.



Type of Mounting PM (for panel mounting without Weld Plate or Hexagon Rail Nut)

- Clamp assembly consisting of:
- 1 Hexagon Head Bolt AS
 - 1 Cover Plate LBBU-DP
 - 1 Sleeve LBBU-HUE
 - 1 Clamp Body LBBU

Order Code
LBBU-PM-322-SA-DP-AS-M8-W3

W3 (Metal parts made of Carbon Steel, zinc/nickel-plated) is the standard option for this type of installation. For UNC threads / bolts, please replace M8 by U5/16.

Alternative sizes (e.g. for bolts M6 and 1/4–20 UNC), materials and surface finishings are available upon request.



Clamp Body - Twin Design
Type LBBU

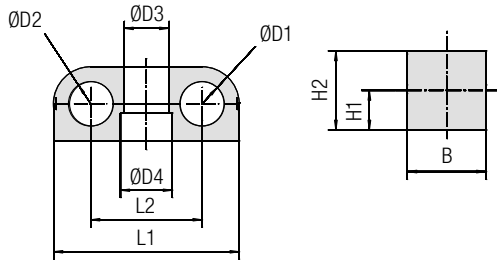

Size 1 and 3 with film hinge



Size 2 in slotted design

Group	Outside Diameters		Nominal Bore Pipe	Ordering Codes (1 Clamp Body)	Dimensions (mm/in)												
	Ø D1 / Ø D2 (mm)	(in)			Ø D3	Ø D4	L1	L2	H1	H2	B						
1D	4			LBBU-104/04-SA-M8/U5/16													
	6			LBBU-106/06-SA-M8/U5/16													
	6,4	1/4		LBBU-106.4/06.4-SA-M8/U5/16													
	8	5/16		LBBU-108/08-SA-M8/U5/16													
	9,5	3/8		LBBU-109.5/09.5-SA-M8/U5/16	12	14	50	30	10	20	20						
	10		1/8	LBBU-110/10-SA-M8/U5/16	.47	.55	1.97	1.18	.39	.79	.79						
	11			LBBU-111/11-SA-M8/U5/16													
	12			LBBU-112/12-SA-M8/U5/16													
	12,7	1/2		LBBU-112.7/12.7-SA-M8/U5/16													
	2D	10		1/8	LBBU-210/10-SA-M8/U5/16												
11				LBBU-211/11-SA-M8/U5/16													
12				LBBU-212/12-SA-M8/U5/16													
12,7		1/2		LBBU-212.7/12.7-SA-M8/U5/16													
13,5			1/4	LBBU-213.5/13.5-SA-M8/U5/16													
14				LBBU-214/14-SA-M8/U5/16	12	14	59	35	12	24	20						
15				LBBU-215/15-SA-M8/U5/16	.47	.55	2.32	1.38	.47	.94	.79						
16		5/8		LBBU-216/16-SA-M8/U5/16													
17,2			3/8	LBBU-217.2/17.2-SA-M8/U5/16													
18				LBBU-218/18-SA-M8/U5/16													
3D	19	3/4		LBBU-219/19-SA-M8/U5/16													
	20			LBBU-220/20-SA-M8/U5/16													
	21,3			LBBU-321.3/21.3-SA-M8/U5/16													
	22	7/8		LBBU-322/22-SA-M8/U5/16													
	23			LBBU-323/23-SA-M8/U5/16													
	25			LBBU-325/25-SA-M8/U5/16	12	14	86	47	20	40	30						
	25,4	1		LBBU-325.4/25.4-SA-M8/U5/16	.47	.55	3.39	1.85	.79	1.57	.79						
	28			LBBU-328/28-SA-M8/U5/16													
	30			LBBU-330/30-SA-M8/U5/16													
	32	1-1/4		LBBU-332/32-SA-M8/U5/16													

Ordering Codes

Clamp Body *LBBU-*1*06/06-*SA-*M8/U5/16

- * Light Series LBBU **LBBU**
- * 1st Part of STAUFF Group **1**
- * Exact outside diameters Ø D1 / Ø D2 (mm) **06/06**
- * Material code (see below) **SA**
- * Thread code (suitable for bolts M8 and U5/16) **M8/U5/16**

Standard Materials

Thermoplastic Elastomer (87 Shore-A)
Colour: Black
Material code: **SA**

See pages 154 / 155 for material properties and technical information.

Alternative materials are available upon request. Please contact STAUFF for further information.

Product Features

- Compact and light-weight design for applications in which space is limited
- Available in 3 different sizes and covering all standard metric and imperial diameters between 4 mm and 32 mm
- Vibration-damping and noise-reducing clamp body material with UV, ozone and weathering-resistant characteristics
- Embedded metal sleeve to ensure stability of the clamp assembly

Additional outside diameters and combinations of different outside diameters are available upon request. Please contact STAUFF for further information.

Type of Mounting SP
(with Weld Plate LBBU-SP)

Clamp assembly consisting of:

- 1 Hexagon Head Bolt AS
- 1 Cover Plate LBBU-DP
- 1 Sleeve LBBU-HUE
- 1 Clamp Body LBBU
- 1 Weld Plate LBBU-SP

Order Code
LBBU-SP-322/22-SA-DP-AS-M8-W10
W10 (Weld Plate made of Carbon Steel, phosphated; Other metal parts made of Carbon Steel, zinc/nickel-plated) is the standard option for this type of installation. For UNC threads / bolts, please replace M8 by U5/16.

Type of Mounting SM
(with Hexagon Rail Nut SM-2-5D)

Clamp assembly consisting of:

- 1 Hexagon Head Bolt AS
- 1 Cover Plate LBBU-DP
- 1 Sleeve LBBU-HUE
- 1 Clamp Body LBBU
- 1 Hexagon Rail Nut SM-2-5D (for use with Mounting Rail TS, see page 24 for details)

Order Code (Mounting Rail TS not included.)
LBBU-SM-322/22-SA-DP-AS-M8-W3
W3 (Metal parts made of Carbon Steel, zinc/nickel-plated) is the standard option for this type of installation. For UNC threads / bolts, please replace M8 by U5/16.

Type of Mounting PM
(for panel mounting without Weld Plate or Hexagon Rail Nut)

Clamp assembly consisting of:

- 1 Hexagon Head Bolt AS
- 1 Cover Plate LBBU-DP
- 1 Sleeve LBBU-HUE
- 1 Clamp Body LBBU

Order Code
LBBU-PM-322/22-SA-DP-AS-M8-W3
W3 (Metal parts made of Carbon Steel, zinc/nickel-plated) is the standard option for this type of installation. For UNC threads / bolts, please replace M8 by U5/16.

Alternative sizes (e.g. for bolts M6 and 1/4–20 UNC), materials and surface finishings are available upon request.

Weld Plate Type LBBU-SP

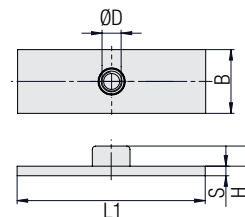
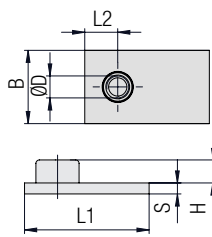

STAUFF Group 1 to 3

STAUFF Group 1D to 3D

Ordering Codes

Weld Plate ***LBBU-SP*1D*M8*W2**

- * Light Series LBBU **LBBU**
- * Weld Plate **-SP**
- * STAUFF Group **1D**
- * Thread code Metric ISO thread: M8 **M8**
 UNC thread: 5/16-18 UNC **U5/16**
- * Material code Carbon Steel, phosphated **W2**

Group STAUFF	Dimensions (mm/in)						Thread G	Ordering Codes (Standard Options)
	Ø D	L1	L2	H	B	S		
1	14	34	9	10,3	20	5	M8	LBBU-SP-1-M8-W2
	.55	1.34	.35	.41	.79	.20	5/16-18 UNC	LBBU-SP-1-U5/16-W2
2	14	39	9	10,3	20	5	M8	LBBU-SP-2-M8-W2
	.55	1.54	.35	.41	.79	.20	5/16-18 UNC	LBBU-SP-2-U5/16-W2
3	14	57,5	15	10,3	30	5	M8	LBBU-SP-3-M8-W2
	.55	2.26	.59	.41	1.18	.20	5/16-18 UNC	LBBU-SP-3-U5/16-W2
1D	14	50	X	10,3	20	5	M8	LBBU-SP-1D-M8-W2
	.55	1.97		.41	.79	.20	5/16-18 UNC	LBBU-SP-1D-U5/16-W2
2D	14	59	X	10,3	20	5	M8	LBBU-SP-2D-M8-W2
	.55	2.32		.41	.79	.20	5/16-18 UNC	LBBU-SP-2D-U5/16-W2
3D	14	86	X	10,3	30	5	M8	LBBU-SP-3D-M8-W2
	.55	3.39		.41	1.18	.20	5/16-18 UNC	LBBU-SP-3D-U5/16-W2

All threaded parts are available with Metric ISO thread or unified coarse (UNC) thread according to dimension table. Alternative sizes (e.g. for bolts M6 and 1/4-20 UNC), materials and surface finishings are available upon request.

Sleeve Type LBBU-HUE

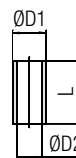

Dimensions applicable only when used with
Weld Plate LBBU-SP (**Type of Mounting SP**)

Dimensions applicable only when used with
Hexagon Rail Nut SM-2-5D (**Type of Mounting SM**)

Dimensions applicable only when used for panel mounting
without Weld Plate or Hexagon Rail Nut (**Type of Mounting PM**)

Group STAUFF	Dimensions (mm/in)			Ordering Codes (Standard Options)
	ØD1	ØD2	L	
1	12	9	13,5	LBBU-HUE-1/1D-SP-M8/U5/16-W3
	.47	.35	.53	
2	12	9	17,5	LBBU-HUE-2/2D-SP-M8/U5/16-W3
	.47	.35	.69	
3	12	9	33,5	LBBU-HUE-3/3D-SP-M8/U5/16-W3
	.47	.35	1.32	
1D	12	9	13,5	LBBU-HUE-1/1D-SP-M8/U5/16-W3
	.47	.35	.53	
2D	12	9	17,5	LBBU-HUE-2/2D-SP-M8/U5/16-W3
	.47	.35	.69	
3D	12	9	33,5	LBBU-HUE-3/3D-SP-M8/U5/16-W3
	.47	.35	1.32	

Group STAUFF	Dimensions (mm/in)			Ordering Codes (Standard Options)
	ØD1	ØD2	L	
1	12	9	12,8	LBBU-HUE-1/1D-SM-M8/U5/16-W3
	.47	.35	.50	
2	12	9	16,8	LBBU-HUE-2/2D-SM-M8/U5/16-W3
	.47	.35	.66	
3	12	9	32,8	LBBU-HUE-3/3D-SM-M8/U5/16-W3
	.47	.35	1.29	
1D	12	9	12,8	LBBU-HUE-1/1D-SM-M8/U5/16-W3
	.47	.35	.50	
2D	12	9	16,8	LBBU-HUE-2/2D-SM-M8/U5/16-W3
	.47	.35	.66	
3D	12	9	32,8	LBBU-HUE-3/3D-SM-M8/U5/16-W3
	.47	.35	1.29	

Group STAUFF	Dimensions (mm/in)			Ordering Codes (Standard Options)
	ØD1	ØD2	L	
1	12	9	18,8	LBBU-HUE-1/1D-PM-M8/U5/16-W3
	.47	.35	.74	
2	12	9	22,7	LBBU-HUE-2/2D-PM-M8/U5/16-W3
	.47	.35	.89	
3	12	9	38,8	LBBU-HUE-3/3D-PM-M8/U5/16-W3
	.47	.35	1.53	
1D	12	9	18,8	LBBU-HUE-1/1D-PM-M8/U5/16-W3
	.47	.35	.74	
2D	12	9	22,7	LBBU-HUE-2/2D-PM-M8/U5/16-W3
	.47	.35	.89	
3D	12	9	38,8	LBBU-HUE-3/3D-PM-M8/U5/16-W3
	.47	.35	1.53	

Alternative sizes (e.g. for bolts M6 and 1/4-20 UNC), materials and surface finishings are available upon request.



Cover Plate
Type LBBU-DP

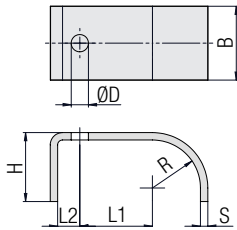

STAUFF Group 1 to 3

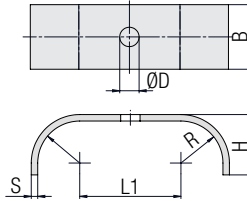

STAUFF Group 1D to 3D



Group STAUFF	Dimensions (mm/in)							Ordering Codes (Standard Options)
	Ø D	L1	L2	R	H	B	S	
1	9	15	9	10	16	20	3	LBBU-DP-1-M8/U5/16-W3
	.35	.59	.35	.39	.63	.79	.12	
2	9	18	9	12	20	20	3	LBBU-DP-2-M8/U5/16-W3
	.35	.71	.35	.47	.79	.79	.12	
3	9	23,5	15	19,5	28	30	3	LBBU-DP-3-M8/U5/16-W3
	.35	.93	.59	.77	1.10	1.18	.12	
1D	9	30	X	10	16	20	3	LBBU-DP-1D-M8/U5/16-W3
	.35	1.18		.39	.63	.79	.12	
2D	9	35	X	12	20	20	3	LBBU-DP-2D-M8/U5/16-W3
	.35	1.38		.47	.79	.79	.12	
3D	9	47	X	19,5	28	20	3	LBBU-DP-3D-M8/U5/16-W3
	.35	1.85		.77	.63	.79	.12	

Ordering Codes

Cover Plate *LBBU-DP-*1D-*M8/U5/16-*W3

- * Light Series LBBU **LBBU**
- * Cover Plate **-DP**
- * STAUFF Group **1D**
- * Thread code (suitable for bolts M8 and U5/16) **M8/U5/16**
- * Material code Carbon Steel, zinc/nickel-plated **W3**

Alternative sizes (e.g. for bolts M6 and 1/4–20 UNC), materials and surface finishings are available upon request.

Hexagon Head Bolt
Type AS

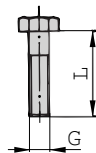

Hexagon Head Bolt AS

(according to DIN 931 / 933 or ANSI / ASME B18.2.1.)
Dimensions applicable only when used with
Weld Plate LBBU-SP (Type of Mounting SP)
or Hexagon Rail Nut SM-2-5D (Type of Mounting SM)

Hexagon Head Bolt AS

(according to DIN 931 / 933 or ANSI / ASME B18.2.1.)
Dimensions applicable only when used for panel mounting
without Weld Plate or Hexagon Rail Nut
(Type of Mounting PM)



Group STAUFF	Dimensions (mm/in) Thread G x L	Ordering Codes (Standard Options)
1	M8 x 25	AS-M8x25-W3
	5/16–18 UNC x 1	AS-U5/16-18x1-W3
2	M8 x 28	AS-M8x28-W3
	5/16–18 UNC x 1-1/8	AS-U5/16-18x1-1/8-W3
3	M8 x 45	AS-M8x45-W3
	5/16–18 UNC x 1-3/4	AS-U5/16-18x1-3/4-W3
1D	M8 x 25	AS-M8x25-W3
	5/16–18 UNC x 1	AS-U5/16-18x1-W3
2D	M8 x 28	AS-M8x28-W3
	5/16–18 UNC x 1-1/8	AS-U5/16-18x1-1/8-W3
3D	M8 x 45	AS-M8x45-W3
	5/16–18 UNC x 1-3/4	AS-U5/16-18x1-3/4-W3

Group STAUFF	Dimensions (mm/in) Thread G x L	Ordering Codes (Standard Options)
1	M8 x 30	AS-M8x30-W3
	5/16–18 UNC x 1-1/4	AS-U5/16-18x1-1/4-W3
2	M8 x 35	AS-M8x35-W3
	5/16–18 UNC x 1-3/8	AS-U5/16-18x1-3/8-W3
3	M8 x 50	AS-M8x50-W3
	5/16–18 UNC x 2	AS-U5/16-18x2-W3
1D	M8 x 30	AS-M8x30-W3
	5/16–18 UNC x 1-1/4	AS-U5/16-18x1-1/4-W3
2D	M8 x 35	AS-M8x35-W3
	5/16–18 UNC x 1-3/8	AS-U5/16-18x1-3/8-W3
3D	M8 x 50	AS-M8x50-W3
	5/16–18 UNC x 2	AS-U5/16-18x2-W3

Ordering Codes

Hexagon Head Bolt *AS-*M8x25-*W3

- * Type of bolt Hexagon Head Bolt (according to DIN 931 / 933 or ANSI / ASME B18.2.1.) **AS**
- * Thread code Thread dimension according to dimension table **M8x25**
- * Material code Carbon Steel, zinc/nickel-plated **W3**

All threaded parts are available with Metric ISO thread or unified coarse (UNC) thread according to dimension table.
Alternative sizes (e.g. for bolts M6 and 1/4–20 UNC), materials and surface finishings are available upon request.



Clamp Body - Single Design Type LB

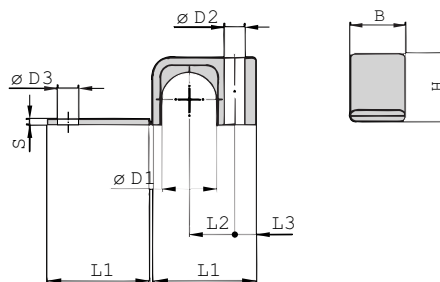

Ordering Codes

Clamp Body

***LB-*1*03.2-*PP**

- * Light Series: Clamp Body / Single Design **LB**
- * STAUFF Group **1**
- * Exact outside diameter Ø D1 (mm) **03.2**
- * Material code (see below) **PP**

Standard Materials



Polypropylene
Colour: Black
Material code: **PP**



Polyamide
Colour: Yellow
Material code: **PA**

See pages 154 / 155 for material properties and technical information.

Alternative materials are available upon request.
Please contact STAUFF for further information.

Applications

- Pneumatics, Instrumentation and Automotive Technology,
Machine Tool Industry, Lubrication, Mechanical Engineering

Group	Outside Diameter Pipe / Tube / Hose Ø D1		Nominal Bore Pipe (in)	Ordering Codes (1 Clamp Body) (** = Material)	Dimensions (mm/in)									
	(mm)	(in)			L1	L2	L3	B	H	S	Ø D2	Ø D3		
1	3,2	1/8		LB-103.2-**-**										
	6			LB-106-**-**	22	9	6,5	12	10,5	2	6,8	7		
	6,4	1/4		LB-106.4-**-**	.87	.35	.26	.47	.41	.08	.27	.28		
	8			LB-108-**-**										
2	9,5	3/8		LB-209.5-**-**										
	10		1/8	LB-210-**-**	27	11	7	16	15	2	6,8	7		
	11,1			LB-211.1-**-**	1.06	.43	.28	.63	.59	.08	.27	.28		
	12			LB-212-**-**										
3	12,7	1/2		LB-312.7-**-**										
	13,5		1/4	LB-313.5-**-**										
	14			LB-314-**-**										
	15			LB-315-**-**	34	15	7	20	22,5	2	6,8	7		
	16	5/8		LB-316-**-**	1.34	.59	.28	.79	.89	.08	.27	.28		
	17,2		3/8	LB-317.2-**-**										
4	18			LB-318-**-**										
	19	3/4		LB-419-**-**										
	20			LB-420-**-**										
	21,3		1/2	LB-421.3-**-**	42	19	7	20	30	2	6,8	7		
	22			LB-422-**-**	1.65	.75	.28	.79	1.18	.08	.27	.28		
	25			LB-425-**-**										
	25,4	1		LB-425.4-**-**										

Additional outside diameters are available upon request. Please contact STAUFF for further information.

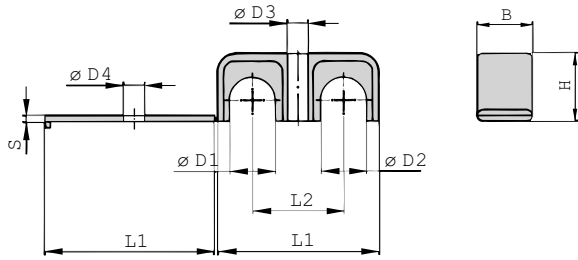

**Clamp Body - Twin Design
Types LBG / LBU**

Group	Outside Diameters		Nominal Bore Pipe	Ordering Codes (1 Clamp Body)	Dimensions (mm/in)							
	Pipe / Tube / Hose Ø D1 / Ø D2 (mm)	(in)			(in)	(** = Material)	L1	L2	B	H	S	Ø D3
1	3,2	1/8		LBG-103.2/03.2-**								
	6			LBG-106/06-**	31	18	12	10,5	2	6,8	7	
	6,4	1/4		LBG-106.4/06.4-**	1.22	.71	.47	.41	.08	.27	.28	
	8			LBG-108/08-**								
2	9,5	3/8		LBG-209.5/09.5-**								
	10		1/8	LBG-210/10-**	39	22	16	15	2	6,8	7	
	11,1			LBG-211.1/11.1-**	1.54	.87	.63	.59	.08	.27	.28	
	12			LBG-212/12-**								
3	12,7	1/2		LBG-312.7/12.7-**								
	13,5		1/4	LBG-313.5/13.5-**								
	14			LBG-314/14-**	53	30	20	22,5	2	6,8	7	
	15			LBG-315/15-**	2.09	1.18	.79	.89	.08	.27	.28	
	16	5/8		LBG-316/16-**								
	17,2		3/8	LBG-317.2/17.2-**								
4	18			LBG-318/18-**								
	19	3/4		LBG-419/19-**								
	20			LBG-420/20-**								
	21,3		1/2	LBG-421.3/21.3-**	70	38	20	30	2	6,8	7	
	22			LBG-422/22-**	2.76	1.50	.79	1.18	.08	.27	.28	
	25			LBG-425/25-**								
	25,4	1		LBG-425.4/25.4-**								

Ordering Codes
Clamp Body *LBG-*1*03.2/03.2-*PP

- * Light Series: Clamp Body / Twin Design with identical diameters **LBG**
- Clamp Body / Twin Design with different diameters **LBU**
- * STAUFF Group **1**
- * Exact outside diameters Ø D1 / Ø D2 (mm) **03.2/03.2**
- * Material code (see below) **PP**

Standard Materials
Polypropylene
 Colour: Black
 Material code: **PP**
Polyamide
 Colour: Yellow
 Material code: **PA**

See pages 154 / 155 for material properties and technical information.

Alternative materials are available upon request. Please contact STAUFF for further information.

Applications

- Pneumatics, Instrumentation and Automotive Technology, Machine Tool Industry, Lubrication, Mechanical Engineering

Additional outside diameters and combinations of different outside diameters (Clamp Body, Type LBU) are available upon request. Please contact STAUFF for further information.

Clamp Body - Single Design Type LN

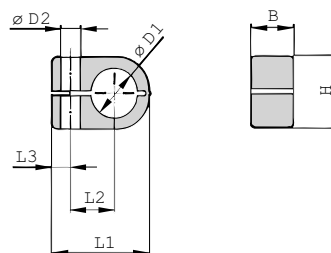

Ordering Codes

Clamp Body

***LN-*1*06-*PP**

- * Light Series: Clamp Body / Single Design **LN**
- * STAUFF Group **1**
- * Exact outside diameter Ø D1 (mm) **06**
- * Material code (see below) **PP**

Standard Materials



Polypropylene
Colour: Green
Material code: **PP**



Polyamide
Colour: Black
Material code: **PA**

See pages 154 / 155 for material properties and technical information.

Alternative materials are available upon request. Please contact STAUFF for further information.

Applications

- Pneumatics, Instrumentation and Automotive Technology, Machine Tool Industry, Lubrication, Mechanical Engineering

Group	Outside Diameter Pipe / Tube / Hose Ø D1		Nominal Bore Pipe (in)	Ordering Codes (1 Clamp Body) (* ** = Material)	Dimensions (mm/in)					
	(mm)	(in)			L1	L2	L3	B	H	Ø D2
1	6			LN-106-***	22	9	7	14,5	13,5	6,8
	6,4	1/4		LN-106.4-***	.87	.35	.28	.57	.53	.27
	8			LN-108-***						
2	8			LN-208-***						
	9,5	3/8		LN-209.5-***	27	11	7	14,5	18,5	6,8
	10		1/8	LN-210-***	1.06	.43	.28	.57	.59	.27
	12			LN-212-***						
3	12,7	1/2		LN-212.7-***						
	10		1/8	LN-310-***						
	12			LN-312-***						
	12,7	1/2		LN-312.7-***	33	15	7	14,5	23,5	6,8
	13,5		1/4	LN-313.5-***	1.30	.59	.28	.57	.93	.27
	14			LN-314-***						
4	15			LN-315-***						
	16	5/8		LN-316-***						
	14			LN-414-***						
	15			LN-415-***						
	16	5/8		LN-416-***						
	17,2		3/8	LN-417.2-***	40	19	7	14,5	30,5	6,8
	18			LN-418-***	1.57	.75	.28	.57	1.20	.27
	19	3/4		LN-419-***						
20			LN-420-***							
21,3		1/2	LN-421.3-***							
22			LN-422-***							

Additional outside diameters are available upon request. Please contact STAUFF for further information.

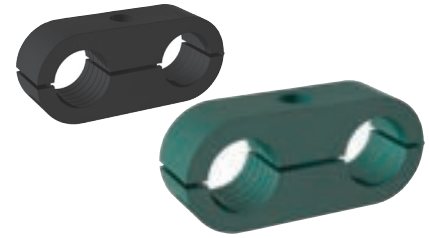
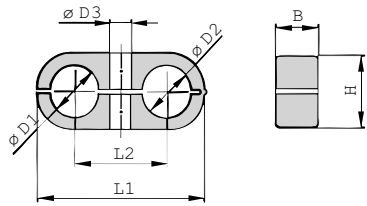

**Clamp Body - Twin Design
Type LNGF / LNUF**

Group STAUFF	Outside Diameters Pipe / Tube / Hose Ø D1 / Ø D2		Nominal Bore Pipe (in)	Ordering Codes (1 Clamp Body) (** = Material)	Dimensions (mm/in)				
	(mm)	(in)			L1	L2	B	H	Ø D3
1	6			LNGF-106/06-**	32	18	14,5	13,5	6,8
	6,4	1/4		LNGF-106.4/06.4-**	1.26	.70	.57	.53	.27
	8			LNGF-108/08-**					
2	8			LNGF-208/08-**					
	9,5	3/8		LNGF-209.5/09.5-**					
	10		1/8	LNGF-210/10-**	41	22	14,5	18,5	6,8
	12			LNGF-212/12-**	1.61	.86	.57	.73	.27
	12,7	1/2		LNGF-212.7/12.7-**					
3	10		1/8	LNGF-310/10-**					
	12			LNGF-312/12-**					
	12,7	1/2		LNGF-312.7/12.7-**					
	13,5		1/4	LNGF-313.5/13.5-**	54	30	14,5	23,5	6,8
	14			LNGF-314/14-**	2.13	1.18	.57	.93	.27
	15			LNGF-315/15-**					
4	16	5/8		LNGF-316/16-**					
	14			LNGF-414/14-**					
	15			LNGF-415/15-**					
	16	5/8		LNGF-416/16-**					
	17,2		3/8	LNGF-417.2/17.2-**	70	38	14,5	30,5	6,8
	18			LNGF-418/18-**	2.76	1.50	.57	1.20	.27
	19	3/4		LNGF-419/19-**					
	20			LNGF-420/20-**					
21,3		1/2	LNGF-421.3/21.3-**						
22			LNGF-422/22-**						

Ordering Codes
Clamp Body *LNGF-*1*06/06-*PP

- * Light Series: Clamp Body / Twin Design with identical diameters **LNGF**
- Clamp Body / Twin Design with different diameters **LNUF**
- * STAUFF Group **1**
- * Exact outside diameters Ø D1 / Ø D2 (mm) **06/06**
- * Material code (see below) **PP**

Standard Materials
Polypropylene
 Colour: Green
 Material code: **PP**
Polyamide
 Colour: Black
 Material code: **PA**

See pages 154 / 155 for material properties and technical information. Alternative materials are available upon request. Please contact STAUFF for further information.

Applications

- Pneumatics, Instrumentation and Automotive Technology, Machine Tool Industry, Lubrication, Mechanical Engineering

Additional outside diameters and combinations of different outside diameters (Clamp Body, type LNUF) are available upon request. Please contact STAUFF for further information.

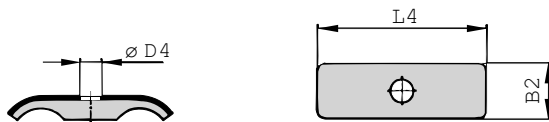
**Cover Plate
Type DPL**

Group STAUFF	Dimensions (mm/in)			Ordering Codes (Standard Options)
	L4	B2	Ø D4	
1	29,5	15,5	6,8	DPL-1-W3
	1.16	.61	.27	
2	40	15,5	6,8	DPL-2-W3
	1.57	.61	.27	
3	51	16	6,8	DPL-3-W3
	2.01	.63	.27	
4	63,5	16	6,8	DPL-4-W3
	2.50	.63	.27	

Ordering Codes
Cover Plate *DPL-*1-*W3

- * Cover Plate for Clamp Body / Twin Design **DPL**
- * STAUFF Group **1**
- * Material code Carbon Steel, zinc/nickel-plated **W3**

Alternative materials and surface finishings are available upon request. Contact STAUFF for further information. Please note: The maximum tightening torque for bolts is 2,5 N·m (1.85 ft·lb).





**Saddle / Piggyback Clamp**

ZR-518

122

**Custom-Designed Saddle / Piggyback Clamps**

122



Saddle / Piggyback Clamps
Type ZR

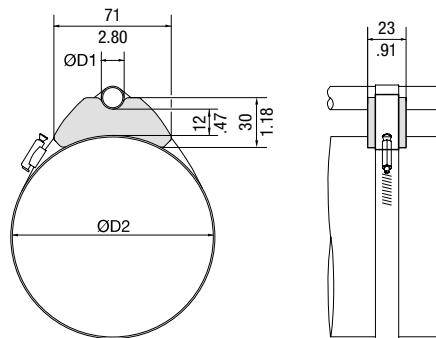

Order Code

Saddle Clamp

ZR-518-SA73-BK

Standard Material



Thermoplastic Elastomer (73 Shore-A)
Colour: Black

See pages 154 / 155 for properties and technical information.

Min/Max Outside Diameters *				Tightening Strap Dimensions (Not Included in Scope of Delivery)			
Pipe / Tube		Ø D2		Length		Width	
Ø D1 (mm)	(in)	(mm)	(in)	(mm)	(in)	(mm)	(in)
10 ... 22	.3987	50 ... 70	1.96 ... 2.76	196 ... 254	7.71 ... 10.00	13	.51
		60 ... 80	2.36 ... 3.15	225 ... 284	8.86 ... 11.18		
		70 ... 90	2.76 ... 3.54	254 ... 314	10.00 ... 12.36		
		80 ... 105	3.15 ... 4.13	284 ... 359	11.18 ... 14.13		
		90 ... 120	3.54 ... 4.72	314 ... 404	12.36 ... 15.90		
		105 ... 140	4.13 ... 5.51	359 ... 464	14.13 ... 18.27		
		125 ... 160	4.92 ... 6.30	419 ... 525	16.50 ... 20.66		
		145 ... 180	5.71 ... 7.09	479 ... 586	18.86 ... 23.07		
		165 ... 200	6.50 ... 7.87	540 ... 647	21.26 ... 25.47		

* Ø D1 depending on Ø D2!

J

Saddle / Piggyback Clamps

Type ZR saddle clamps from STAUFF allow direct fixing and safe guiding of pipes, tubes and hoses on hydraulic cylinders and other round or oval structures, without causing damage to their strength or integrity as with screw-fixing or welding and without preparation or reworking of the surface coating. The simple system also allows a pipe, tube or hose with a small outer diameter to be installed on top of a significantly larger one.

The position can be adjusted at any time thanks to free axial and radial positioning of the clamps on the structure. This also makes the system suitable for retrofitting.

The standard version ZR-518 made of thermoplastic elastomer material covers diameters in a range from 50 to 200 mm / 1.96 to 7.87 in for the cylinder and from 10 to 22 mm / .39 to .87 inch for the attached tube or hose. The diameters to be covered are used to calculate the overall length of the required tightening straps or the dimensions of the steel strap or worm drive hose clamp, e.g. according to DIN 3017.

STAUFF meets deviating requirements with numerous other variants which were implemented in the past and can be manufactured again at any time.

If required, customised clamps can be developed for specific requirements or manufactured based on drawings and models provided.

Please contact STAUFF for further information.



Dimensional drawings: All dimensions in mm (in).



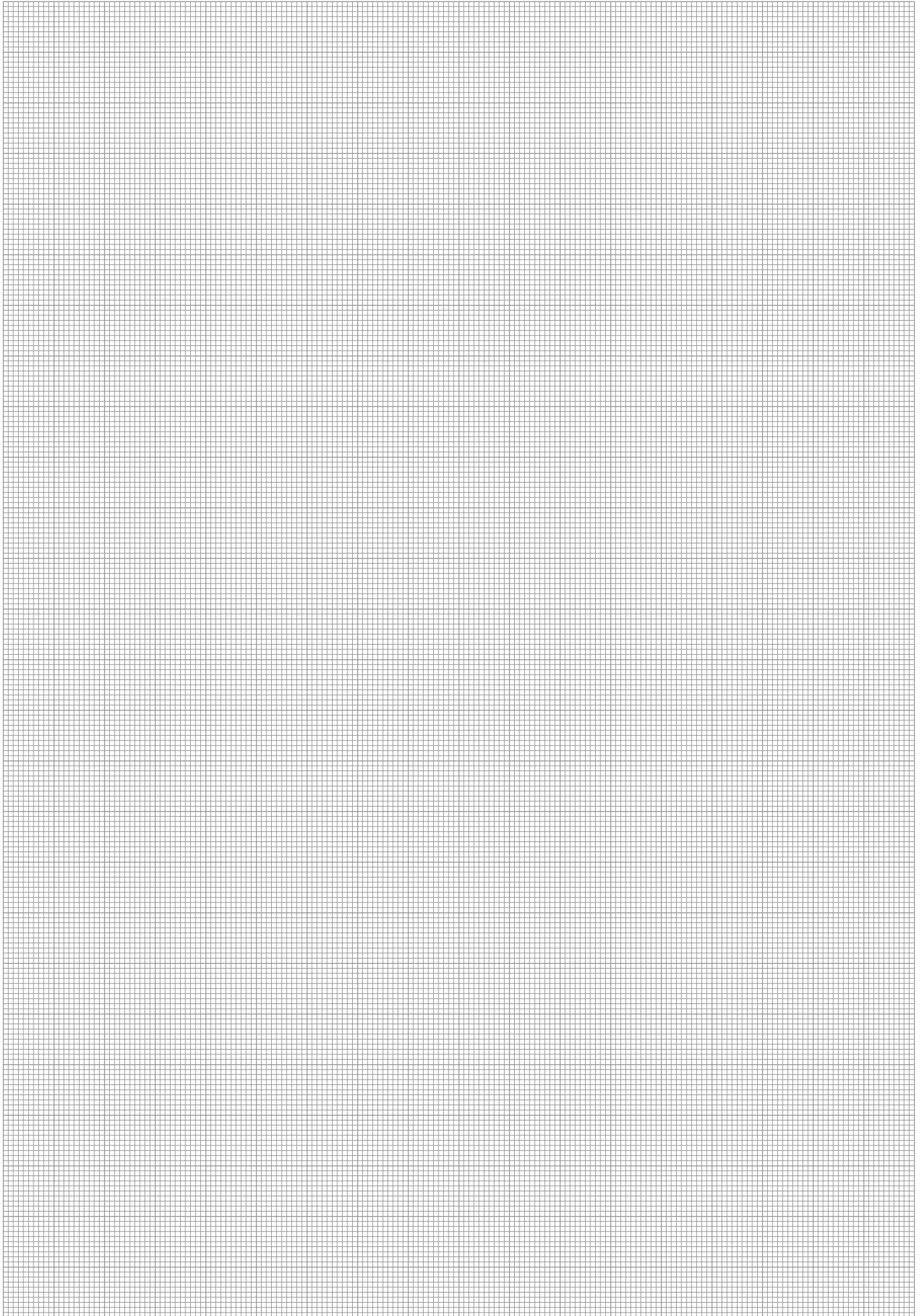

J







**Flat Steel U-Bolt
with Plastic Pipe Saddle (Short) and U-Profile**
FB / RUK

126



**Round Steel U-Bolt
with Plastic Pipe Saddle (Short)**
RB / RUK

128



**Round Steel U-Bolt
with Plastic Pipe Saddle (Long)**
RB / RUL

130



**Round Steel U-Bolt (DIN 3570, Type A)
without Plastic Pipe Saddle**
RBD

132



**Flat Steel U-Bolt with Plastic Pipe Saddle (Short) and U-Profile
Type FB+RUK (To be used as Fixed Point Clamps only)**

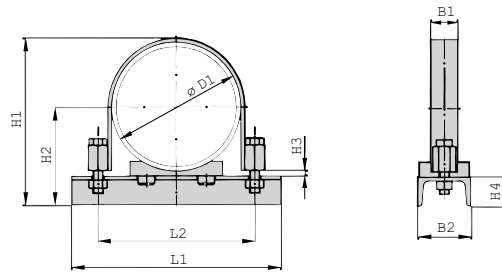
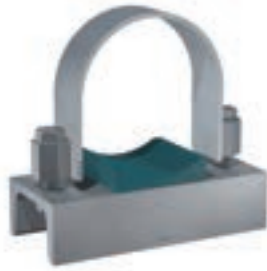

Flat Steel U-Bolt (type FB) with Plastic Pipe Saddle (type RUK), U-Profile and Hexagon Head Bolts

Ordering Codes

Clamp Assembly *FB+RUK-*48.3-*PP-*W1

One clamp assembly is consisting of one Flat Steel U-Bolt (type FB), one Plastic Pipe Saddle (type RUK), one U-Profile (to DIN 1026) with two Nuts (to DIN EN ISO 4032) and two Hexagon Head Bolts (to DIN EN ISO 4014 / 4017).

- * Clamp Assembly (as listed above) **FB+RUK**
- * Exact outside diameter Ø D1 (mm) **48.3**
- * Material of Pipe Saddle (see below) **PP**
- * Material code Carbon Steel, uncoated **W1**
Carbon Steel, zinc-plated, blue-chromated **W33**
Stainless Steel V4A 1.4401 / 1.4571 (AISI 316 / 316 Ti) **W5**
- Please note: The U-Profile (to DIN 1026) is made of Carbon Steel, uncoated.
- Please note: All items are supplied assembled.

Standard Materials for Plastic Pipe Saddles

K



Polypropylene
Colour: Green
Material code: **PP**



Polyamide
Colour: Black
Material code: **PA**

See pages 154 / 155 for material properties and technical information.

Alternative materials are available upon request. Please contact STAUFF for further information.

Applications

- Standing or hanging installation of pipes and tubes on beams, profiles and consoles
- Design with two threaded ends allows for ideal adaptation to suit the exact outer diameter of the pipe or tube

Diameter Nominal DN	Outside Diameter Pipe / Tube Ø D1 (mm) (in)		Nominal Bore Pipe (in)	Dimensions (mm/in)						U-Profile (DIN 1026) B2 x H4
	Flat Steel U-Bolt (Type FB)									
				L1	L2	H1	H2	H3	B1	
40	48,3	1.93	1-1/2	100	76	95	67	5	20 x 3	50 x 38
				3.94	2.99	3.74	2.64	.20	.78 x .12	1.97 x 1.50
50	57	2.28	2	115	85	103	71,5	5	20 x 3	50 x 38
				4.53	3.35	4.06	2.81	.20	.78 x .12	1.97 x 1.50
65	60,3	2.41	2	115	88	106	73,2	5	20 x 3	50 x 38
				4.53	3.46	4.17	2.88	.20	.78 x .12	1.97 x 1.50
80	76,1	3.04	2-1/2	132	104	122	81	5	20 x 3	50 x 38
				5.20	4.09	4.80	3.19	.20	.78 x .12	1.97 x 1.50
100	88,9	3.56	3	160	121	146	97,5	8	40 x 4	80 x 45
				6.30	4.76	5.75	3.84	.31	1.57 x .16	3.15 x 1.77
100	108	4.32	4	170	140	165	107	8	40 x 4	80 x 45
				6.69	5.51	6.50	4.21	.31	1.57 x .16	3.15 x 1.77
125	114,3	4.57	4	180	147	171	110	8	40 x 4	80 x 45
				7.09	5.79	6.73	4.33	.31	1.57 x .16	3.15 x 1.77
125	133	5.32	5	210	165	190	119,5	8	40 x 4	80 x 45
				8.27	6.50	7.48	4.70	.31	1.57 x .16	3.15 x 1.77
150	139,7	5.59	5	210	172	197	123	8	40 x 4	80 x 45
				8.27	6.77	7.76	4.84	.31	1.57 x .16	3.15 x 1.77
150	159	6.36	6	265	201	220	132,5	8	40 x 6	80 x 45
				1.43	7.91	8.66	5.22	.31	1.57 x .24	3.15 x 1.77
175	168,3	6.73	6	275	211	230	137	8	40 x 6	80 x 45
				1.83	8.31	9.06	5.39	.31	1.57 x .24	3.15 x 1.77
200	193,7	7.75	8	305	236	255	150	8	40 x 6	80 x 45
				12.01	9.29	1.04	5.91	.31	1.57 x .24	3.15 x 1.77
200	216	8.64	8	320	258	277	161	8	40 x 6	80 x 45
				12.60	10.16	1.91	6.34	.31	1.57 x .24	3.15 x 1.77
250	219,1	8.76	10	320	261	280	162,5	8	40 x 6	80 x 45
				12.60	1.28	11.02	6.40	.31	1.57 x .24	3.15 x 1.77
250	267	10.68	10	380	324	328	186,5	8	40 x 8	80 x 45
				14.96	12.76	12.91	7.34	.31	1.57 x .31	3.15 x 1.77
300	273	10.92	10	385	330	334	189,5	8	40 x 8	80 x 45
				15.16	12.99	13.15	7.46	.31	1.57 x .31	3.15 x 1.77
300	318	12.72	12	440	375	382	212	8	40 x 8	80 x 45
				17.32	14.76	15.04	8.35	.31	1.57 x .31	3.15 x 1.77
350	323,9	12.96	12	450	381	390	215	8	40 x 8	80 x 45
				17.72	15.00	15.35	8.46	.31	1.57 x .31	3.15 x 1.77
350	355,6	14.22	14	480	417,5	421	235	12	60 x 8	100 x 50
				18.90	16.44	16.57	9.25	.47	2.36 x .31	3.94 x 1.97
400	368	14.72	16	490	430	434	242	12	60 x 8	100 x 50
				19.29	16.93	17.09	9.53	.47	2.36 x .31	3.94 x 1.97
400	406,4	16.26	16	550	468,5	472	261	12	60 x 8	100 x 50
				21.65	18.44	18.58	10.28	.47	2.36 x .31	3.94 x 1.97
400	419	16.76	18	550	481	485	267,5	12	60 x 8	100 x 50
				21.65	18.94	19.09	10.53	.47	2.36 x .31	3.94 x 1.97
500	457	18.28	20	585	519	523	286,5	12	60 x 8	100 x 50
				23.03	20.43	20.59	11.28	.47	2.36 x .31	3.94 x 1.97
500	508	20.32	20	630	570	574	312	12	60 x 8	100 x 50
				24.80	22.44	22.60	12.28	.47	2.36 x .31	3.94 x 1.97
500	521	20.84	20	640	583	587	319	12	60 x 8	100 x 50
				25.20	22.96	23.11	12.56	.47	2.36 x .31	3.94 x 1.97

Alternative materials and surface finishings are available upon request. Contact STAUFF for further information.

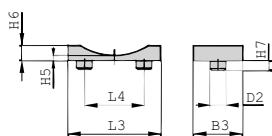

**Flat Steel U-Bolt with Plastic Pipe Saddle (Short) and U-Profile
(To be used as Fixed Point Clamps only) Type FB+RUK**

Plastic Pipe Saddle (type RUK)

(For size DN 40, dimension L4 is staggered by 90°)

Hexagon Head Bolt AS

(according to DIN EN ISO 4014 / 4017)

Diameter Nominal DN	Outside Diameter Pipe / Tube Ø D1		Nominal Bore Pipe (in)	Dimensions (mm/in)							Hexagon Head Bolt (DIN EN ISO 4014 / 4017) Thread G x L
	(mm)	(in)		Plastic Pipe Saddle (type RUK)							
				L3	L4	B3	D2	H5	H6	H7	
40	48,3	1.93	1-1/2	24	25	35	8	5	8	5	M10 x 40
				.94	.98	1.38	.31	.20	.31	.20	
50	57	2.28	2	38	25	50	10	5	10	6	M10 x 40
				1.50	.98	1.97	.39	.20	.39	.24	
65	76,1	3.04	2-1/2	38	25	50	10	5	10	6	M10 x 40
				1.50	.98	1.97	.39	.20	.39	.24	
80	88,9	3.56	3	75	40	70	15	8	17	10	M 12 x 55
				2.95	1.57	2.76	.59	.31	.67	.39	
100	108	4.32	4	75	40	70	15	8	17	10	M 12 x 55
				2.95	1.57	2.76	.59	.31	.67	.39	
125	133	5.32	5	75	40	70	15	8	17	10	M 12 x 55
				2.95	1.57	2.76	.59	.31	.67	.39	
150	159	6.36	6	140	90	75	25	8	26	10	M 16 x 75
				5.51	3.54	2.95	.98	.31	1.02	.39	
175	168,3	6.73	6	140	90	75	25	8	26	10	M 16 x 75
				5.51	3.54	2.95	.98	.31	1.02	.39	
200	193,7	7.75	8	140	90	75	25	8	26	10	M 16 x 75
				5.51	3.54	2.95	.98	.31	1.02	.39	
250	216	8.64	10	140	90	75	25	8	26	10	M 16 x 75
				5.51	3.54	2.95	.98	.31	1.02	.39	
300	219,1	8.76	10	140	90	75	25	8	26	10	M 16 x 75
				5.51	3.54	2.95	.98	.31	1.02	.39	
350	267	10.68	12	140	90	75	25	8	26	10	M 20 x 80
				5.51	3.54	2.95	.98	.31	1.02	.39	
400	273	10.92	12	140	90	75	25	8	26	10	M 20 x 80
				5.51	3.54	2.95	.98	.31	1.02	.39	
450	318	12.72	14	220	150	75	30	8	32	10	M 20 x 80
				8.66	5.91	2.95	1.18	.31	1.26	.39	
500	323,9	12.96	14	220	150	75	30	8	32	10	M 20 x 80
				8.66	5.91	2.95	1.18	.31	1.26	.39	
550	355,6	14.22	16	220	150	75	30	8	32	10	M 24 x 100
				8.66	5.91	2.95	1.18	.31	1.26	.39	
600	368	14.72	16	220	150	75	30	8	32	10	M 24 x 100
				8.66	5.91	2.95	1.18	.31	1.26	.39	
650	406,4	16.26	18	220	150	75	30	8	32	10	M 24 x 100
				8.66	5.91	2.95	1.18	.31	1.26	.39	
700	419	16.76	18	220	150	75	30	8	32	10	M 24 x 100
				8.66	5.91	2.95	1.18	.31	1.26	.39	
750	457	18.28	20	220	150	75	30	8	32	10	M 24 x 100
				8.66	5.91	2.95	1.18	.31	1.26	.39	
800	508	20.32	20	220	150	75	30	8	32	10	M 24 x 100
				8.66	5.91	2.95	1.18	.31	1.26	.39	
850	521	20.84	20	220	150	75	30	8	32	10	M 24 x 100
				8.66	5.91	2.95	1.18	.31	1.26	.39	

Ordering Codes
Flat Steel U-Bolt *FB-*A-48.3-*W1

 * Flat Steel U-Bolt **FB**

 * Exact outside diameter Ø D1 (mm) **A-48.3**

 * Material code Carbon Steel, uncoated **W1**

 Carbon Steel, zinc-plated, blue-chromated **W32**

 Stainless Steel V4A **W5**

1.4401 / 1.4571 (AISI 316 / 316 Ti)

only Plastic Pipe Saddle *RUK-*48.3-*PP

 * Plastic Pipe Saddle (Short) **RUK**

 * Exact outside diameter Ø D1 (mm) **48.3**

 * Material of Pipe Saddle (see below) **PP**

Please note: All items are supplied assembled.

Standard Materials for Plastic Pipe Saddles
Polypropylene
 Colour: Green
 Material code: **PP**
Polyamide
 Colour: Black
 Material code: **PA**

See pages 154 / 155 for material properties and technical information.

Alternative materials are available upon request. Please contact STAUFF for further information.

Applications

- Standing or hanging installation of pipes and tubes on beams, profiles and consoles
- Design with two threaded ends allows for ideal adaptation to suit the exact outer diameter of the pipe or tube

Alternative materials and surface finishings are available upon request. Contact STAUFF for further information.



Round Steel U-Bolt with Plastic Pipe Saddle (Short) Type RB+RUK

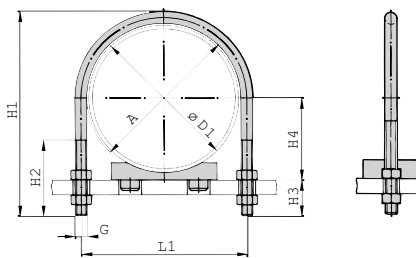

Round Steel U-Bolt (type RB) with Plastic Pipe Saddle (type RUK)

Ordering Codes

Clamp Assembly *RB+RUK-*48.3-*PP-*W1

One clamp assembly is consisting of one Round Steel U-Bolt (type RB), one Plastic Pipe Saddle (type RUK) and four Nuts (to DIN EN ISO 4032).

- * Clamp Assembly (as listed above) **RB+RUK**
- * Exact outside diameter Ø D1 (mm) **48.3**
- * Material of Pipe Saddle (see below) **PP**
- * Material code Carbon Steel, uncoated **W1**
Carbon Steel, zinc-plated, blue-chromated **W32**
Stainless Steel V4A 1.4401 / 1.4571 (AISI 316 / 316 Ti) **W5**

Please note: All items are supplied non-assembled.

Standard Materials for Plastic Pipe Saddles



Polypropylene
Colour: Green
Material code: **PP**



Polyamide
Colour: Black
Material code: **PA**

See pages 154 / 155 for material properties and technical information.

Alternative materials are available upon request. Please contact STAUFF for further information.

Applications

- Standing or hanging installation of pipes and tubes on beams, profiles and consoles
- Design with two threaded ends allows for ideal adaptation to suit the exact outer diameter of the pipe or tube

Diameter Nominal DN	Outside Diameter Pipe / Tube Ø D1 (mm) (in)		Nominal Bore Pipe (in)	Dimensions (mm/in)						
	Round Steel U-Bolt (Type RB)			A	L1	H1	H2	H3	H4	Thread G
20	25	.98	3/4	30	40	73,5	41	30	17,5	M10
	26,9	1.06		1.18	1.57	2.89	1.61	1.18	.69	
25	30	1.18	1	38	48	81	48	30	20	M10
	33,7	1.33		1.50	1.89	3.19	1.89	1.18	.79	
32	38	1.50	1-1/4	46	56	89	48	30	24	M10
	42,4	1.69		1.81	2.20	3.50	1.89	1.18	.94	
40	44,5	1.76	1-1/2	52	62	100	55	35	27,2	M10
	48,3	1.90		2.05	2.44	3.94	2.17	1.38	1.07	
50	57	2.28	2	64	76	118	63	39	33,5	M12
	60,3	2.41		2.52	2.99	4.65	2.48	1.54	1.32	
65	76,1	3.04	2-1/2	82	94	135	77	39	43	M12
	80	3.56		3	3.70	4.17	5.98	3.23	1.61	
100	108	4.32	4	120	136	190	105	49	62	M16
	114,3	4.57		4.72	5.35	7.48	4.13	1.93	2.44	
125	133	5.32	5	148	164	217	105	49	74,5	M16
	139,7	5.59		5.83	6.46	8.54	4.13	1.93	2.93	
150	159	6.36	6	176	192	247	105	51	87,5	M16
	168,3	6.73		6.93	7.56	9.72	4.13	2.01	3.44	
175	193,7	7.75	7	202	218	273	105	51	105	M16
	200	8.64		8.98	7.96	8.58	10.75	4.13	2.01	
200	216	8.64	8	228	248	311	125	59	116	M20
	219,1	8.76		8.98	9.76	12.24	4.92	2.32	4.57	
250	267	10.68	10	282	303	364	125	59	141,5	M20
	273	10.92		11.10	11.93	14.33	4.92	2.32	5.57	
300	318	12.72	12	332	302	364	125	59	144,5	M20
	323,9	12.96		13.07	11.89	14.33	4.92	2.32	5.69	
350	355,6	14.22	14	378	352	418	125	62	167	M20
	368	14.72		14.88	13.86	16.46	4.92	2.44	6.57	
400	406,4	16.26	16	428	402	475	145	70	186	M24
	419	16.76		16.85	15.83	18.70	5.71	2.76	7.32	
500	508	20.32	20	530	402	475	145	70	192	M24
	521	20.84		20.87	17.80	20.71	5.71	2.76	8.56	
					554	627	145	70	262	M24
					21.81	24.69	5.71	2.76	10.31	
					554	627	145	70	269	M24
					21.81	24.69	5.71	2.76	10.59	

Alternative materials and surface finishings are available upon request. Contact STAUFF for further information.

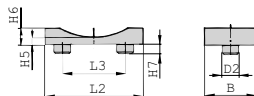

**Round Steel U-Bolt with Plastic Pipe Saddle (Short)
Type RB+RUK**

Plastic Pipe Saddle (type RUK)
(For sizes DN 20 to DN 40)

Plastic Pipe Saddle (type RUK)
(From size DN 50 on)

Diameter Nominal DN	Outside Diameter Pipe / Tube Ø D1 (mm) (in)		Nominal Bore Pipe (in)	Dimensions (mm/in) Plastic Pipe Saddle (Type RUK)								
	A	L2		L3	B	H5	H6	H7	D2			
20	25	.98		30	35	25	24	5	8	5	8	
	26,9	1.06	3/4	1.18	1.38	.98	.94	.20	.31	.20	.31	.31
25	30	1.18		38	35	25	24	5	8	5	8	
	33,7	1.33	1	1.50	1.38	.98	.94	.20	.31	.20	.31	.31
32	38	1.50		46	35	25	24	5	8	5	8	
	42,4	1.69	1-1/4	1.81	1.38	.98	.94	.20	.31	.20	.31	.31
40	44,5	1.76		52	35	25	24	5	8	5	8	
	48,3	1.90	1-1/2	2.05	1.38	.98	.94	.20	.31	.20	.31	.31
50	57	2.28		64	38	25	50	5	10	6	10	
	60,3	2.41	2	2.52	1.50	.98	1.97	.20	.39	.24	.39	.39
65	76,1	3.04	2-1/2	82	38	25	50	5	10	6	10	
				3.23	1.50	.98	1.97	.20	.39	.24	.39	.39
80	88,9	3.56	3	94	75	40	70	8	17	10	15	
				3.70	2.95	1.57	2.76	.31	.67	.39	.59	.59
100	108	4.32		120	75	40	70	8	17	10	15	
	114,3	4.57	4	4.72	2.95	1.57	2.76	.31	.67	.39	.59	.59
125	133	5.32		148	75	40	70	8	17	10	15	
	139,7	5.59	5	5.83	2.95	1.57	2.76	.31	.67	.39	.59	.59
150	159	6.36		176	140	90	75	8	26	10	25	
	168,3	6.73	6	6.93	5.51	3.54	2.95	.31	1.02	.39	.98	.98
175	193,7	7.75		202	140	90	75	8	26	10	25	
				7.96	5.51	3.54	2.95	.31	1.02	.39	.98	.98
200	216	8.64		228	140	90	75	8	26	10	25	
	219,1	8.76	8	8.98	5.51	3.54	2.95	.31	1.02	.39	.98	.98
250	267	10.68		282	140	90	75	8	26	10	25	
	273	10.92	10	11.10	5.51	3.54	2.95	.31	1.02	.39	.98	.98
300	318	12.72		332	220	150	75	8	32	10	30	
	323,9	12.96	12	13.07	8.66	5.91	2.95	.31	1.26	.39	1.18	1.18
350	355,6	14.22	14	378	220	150	75	8	32	10	30	
	368	14.72		14.88	8.66	5.91	2.95	.31	1.26	.39	1.18	1.18
400	406,4	16.26	16	428	220	150	75	8	32	10	30	
	419	16.76		16.85	8.66	5.91	2.95	.31	1.26	.39	1.18	1.18
500	508	2.32	20	530	220	150	75	8	32	10	30	
	521	2.84		2.87	8.66	5.91	2.95	.31	1.26	.39	1.18	1.18

Ordering Codes
Round Steel U-Bolt *RB-*A-52-*W1-*COMPL

One Round Steel U-Bolt (type RB) includes four Nuts (to DIN EN ISO 4032).

- * Round Steel U-Bolt **RB**
- * Dimension A (mm) **A-52**
- * Material code Carbon Steel, uncoated **W1**
- Carbon Steel, zinc-plated, blue-chromated **W32**
- Stainless Steel V4A 1.4401 / 1.4571 (AISI 316 / 316 Ti) **W5**

only Plastic Pipe Saddle *RUK-*48.3-*PP

- * Plastic Pipe Saddle (Short) **RUK**
- * Exact outside diameter Ø D1 (mm) **48.3**
- * Material of Pipe Saddle (see below) **PP**

Standard Materials for Plastic Pipe Saddles

- Polypropylene**
Colour: Green
Material code: **PP**
- Polyamide**
Colour: Black
Material code: **PA**

See pages 154 / 155 for material properties and technical information.

Alternative materials are available upon request. Please contact STAUFF for further information.

Applications

- Standing or hanging installation of pipes and tubes on beams, profiles and consoles
- Design with two threaded ends allows for ideal adaptation to suit the exact outer diameter of the pipe or tube

Alternative materials and surface finishings are available upon request. Contact STAUFF for further information.



Round Steel U-Bolt with Plastic Pipe Saddle (Long) Type RB+RUL

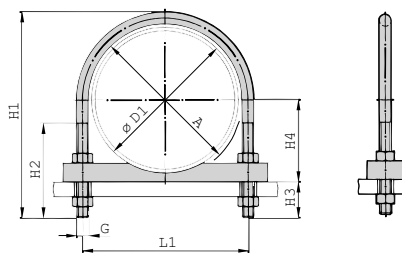

Round Steel U-Bolt (type RB) with Plastic Pipe Saddle (type RUL)

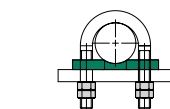

Recommended Installation
<DN50

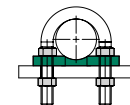

Recommended Installation
>DN50

Ordering Codes

Clamp Assembly *RB+RUL-*48.3-*PP-*W1

One clamp assembly is consisting of one Round Steel U-Bolt (type RB), one Plastic Pipe Saddle (type RUL) and four Nuts (to DIN EN ISO 4032).

- * Clamp Assembly (as listed above) **RB+RUL**
- * Exact outside diameter Ø D1 (mm) **48.3**
- * Material of Pipe Saddle (see below) **PP**
- * Material code Carbon Steel, uncoated **W1**
Carbon Steel, zinc-plated, blue-chromated **W32**
Stainless Steel V4A 1.4401 / 1.4571 (AISI 316 / 316 Ti) **W5**

Please note: All items are supplied non-assembled.

Standard Materials for Plastic Pipe Saddles

Polypropylene
Colour: Green
Material code: **PP**

Polyamide
Colour: Black
Material code: **PA**

See pages 154 / 155 for material properties and technical information.

Alternative materials are available upon request. Please contact STAUFF for further information.

Applications

- Standing or hanging installation of pipes and tubes on beams, profiles and consoles
- Design with two threaded ends allows for ideal adaptation to suit the exact outer diameter of the pipe or tube

Diameter Nominal DN	Outside Diameter Pipe / Tube Ø D1 (mm) (in)		Nominal Bore Pipe (in)	Dimensions (mm/in)						
	Round Steel U-Bolt (Type RB)			A	L1	H1	H2	H3	H4	Thread G
20	25	.98		30	40	73,5	41	30	17,5	M10
	26,9	1.06	3/4	1.18	1.57	2.89	1.61	1.18	.69	
25	30	1.18		38	48	81	48	30	20	M10
	33,7	1.33	1	1.50	1.89	3.19	1.89	1.18	.79	
32	38	1.50		46	56	89	48	30	24	M10
	42,4	1.69	1-1/4	1.81	2.20	3.50	1.89	1.18	.94	
40	44,5	1.76		52	62	100	55	35	27,2	M10
	48,3	1.90	1-1/2	2.05	2.44	3.94	2.17	1.38	1.07	
50	57	2.28		64	76	118	63	39	33,5	M12
	60,3	2.41	2	2.52	2.99	4.65	2.48	1.54	1.32	
65	76,1	3.04	2-1/2	82	94	135	77	39	43	M12
				3.23	3.70	5.31	3.03	1.54	1.69	
80	88,9	3.56	3	94	106	152	82	39	54,5	M12
				3.70	4.17	5.98	3.23	1.54	2.15	
100	108	4.32		120	136	190	105	47	64	M16
	114,3	4.57	4	4.72	5.35	7.48	4.13	1.85	2.52	
125	133	5.32		148	164	217	105	47	76,5	M16
	139,7	5.59	5	5.83	6.46	8.54	4.13	1.85	3.01	
150	159	6.36		176	192	247	105	47	80	M16
	168,3	6.73	6	6.93	7.56	9.72	4.13	1.85	3.15	
175	193,7	7.75		202	218	273	105	47	91,5	M16
				7.96	8.58	10.75	4.13	1.85	3.60	
200	216	8.64		228	248	311	125	55	120	M20
	219,1	8.76	8	8.98	9.76	12.24	4.92	2.17	4.72	
250	267	10.68		282	303	364	125	55	145,5	M20
	273	10.92	10	11.10	11.93	14.33	4.92	2.17	5.73	
300	318	12.72		332	352	418	125	55	174	M20
	323,9	12.96	12	13.07	13.86	16.46	4.92	2.17	6.85	
350	355,6	14.22	14	378	402	475	145	63	193	M24
	368	14.72		14.88	15.83	18.70	5.71	2.48	7.60	
400	406,4	16.26	16	428	452	526	145	63	218	M24
	419	16.76		16.85	17.80	20.71	5.71	2.48	8.58	
500	508	20.32	20	530	554	627	145	63	269	M24
	521	20.84		20.87	21.81	24.69	5.71	2.48	10.59	

Alternative materials and surface finishings are available upon request. Contact STAUFF for further information.

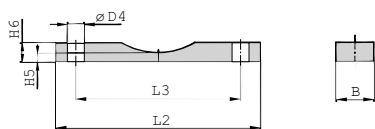

**Round Steel U-Bolt with Plastic Pipe Saddle (Long)
Type RB+RUL**

Plastic Pipe Saddle (type RUL)

Diameter Nominal DN	Outside Diameter Pipe / Tube Ø D1 (mm) (in)		Nominal Bore Pipe (in)	Dimensions (mm/in) Plastic Pipe Saddle (Type RUL)						
	A	L2		L3	B	H5	H6	Ø D4		
20	25 26,9	.98 1.06	3/4	30 1.18	75	40	30	5	12	11
					2.95	1.57	1.18	.20	.47	.43
25	30 33,7	1.18 1.33	1	38 1.50	80	48	30	5	12	11
					3.15	1.89	1.18	.20	.47	.43
32	38 42,4	1.50 1.69	1-1/4	46 1.81	90	56	30	5	12	11
					3.54	2.20	1.18	.20	.47	.43
40	44,5 48,3	1.76 1.90	1-1/2	52 2.05	95	62	35	5	15	11
					3.74	2.44	1.38	.20	.59	.43
50	57 60,3	2.28 2.41	2	64 2.52	110	76	35	5	15	14
					4.33	2.99	1.38	.20	.59	.55
65	76,1	3.04	2-1/2	82 3.23	135	94	35	5	15	14
					5.31	3.70	1.38	.20	.59	.55
80	88,9	3.56	3	94 3.70	145	106	40	10	20	14
					5.71	4.17	1.57	.39	.79	.55
100	108 114,3	4.32 4.57	4	120 4.72	190	136	40	10	20	18
					7.48	5.35	1.57	.39	.79	.71
125	133 139,7	5.32 5.59	5	148 5.83	220	164	40	10	20	18
					8.66	6.46	1.57	.39	.79	.71
150	159 168,3	6.36 6.73	6	176 6.93	250	192	50	12	25	18
					9.84	7.56	1.97	.47	.98	.71
175	193,7	7.75		202 7.96	270	218	50	12	25	18
					10.63	8.58	1.97	.47	.98	.71
200	216 219,1	8.64 8.76	8	228 8.98	315	248	50	12	25	22
					12.40	9.76	1.97	.47	.98	.87
250	267 273	10.68 10.92	10	282 11.10	370	302	50	12	25	22
					14.57	11.89	1.97	.47	.98	.87
300	318 323,9	12.72 12.96	12	332 13.07	420	352	60	15	30	22
					16.54	13.86	2.36	.59	1.18	.87
350	355,6 368	14.22 14.72	14	378 14.88	480	402	60	15	30	26
					18.90	15.83	2.36	.59	1.18	1.02
400	406,4 419	16.26 16.76	16	428 16.85	540	452	60	15	30	26
					21.26	17.80	2.36	.59	1.18	1.02
500	508 521	20.32 20.84	20	530 20.87	640	554	60	15	30	26
					25.20	21.81	2.36	.59	1.18	1.02
					640	554	60	15	30	26
					25.20	21.81	2.36	.59	1.18	1.02

Ordering Codes
Round Steel U-Bolt *RB-*A-52-*W1-*COMPL

One Round Steel U-Bolt (type RB) includes four Nuts (to DIN EN ISO 4032).

- * Round Steel U-Bolt **RB**
- * Dimension A (mm) **A-52**
- * Material code Carbon Steel, uncoated **W1**
Carbon Steel, zinc-plated, blue-chromated **W32**
Stainless Steel V4A 1.4401 / 1.4571 (AISI 316 / 316 Ti) **W5**

only Plastic Pipe Saddle *RUL-*48.3-*PP

- * Plastic Pipe Saddle (Long) **RUL**
- * Exact outside diameter Ø D1 (mm) **48.3**
- * Material of Pipe Saddle (see below) **PP**

Standard Materials for Plastic Pipe Saddles

Polypropylene
 Colour: Green
 Material code: **PP**

Polyamide
 Colour: Black
 Material code: **PA**

See pages 154 / 155 for material properties and technical information.

Alternative materials are available upon request. Please contact STAUFF for further information.

Applications

- Standing or hanging installation of pipes and tubes on beams, profiles and consoles
- Design with two threaded ends allows for ideal adaptation to suit the exact outer diameter of the pipe or tube

Alternative materials and surface finishings are available upon request. Contact STAUFF for further information.



**Round Steel U-Bolt (without Plastic Pipe Saddle)
Type RBD (DIN 3570, Type A)**

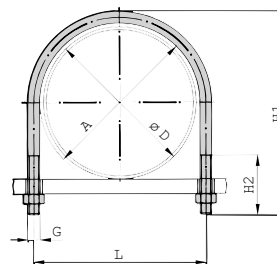

Round Steel U-Bolt (type RBD)

Ordering Codes

Clamp Assembly *RBD-*A-30-*W1-*COMPL

One clamp assembly is consisting of one Round Steel U-Bolt (type RBD according to DIN 3570, Type A) and two Nuts (to DIN EN ISO 4032).

- * Clamp Assembly (as listed above) **RBD**
- * Dimension A (mm) **A-30**
- * Material code Carbon Steel, uncoated **W1**
Carbon Steel, zinc-plated, blue-chromated **W32**
Stainless Steel V4A 1.4401 / 1.4571 (AISI 316 / 316 Ti) **W5**

Please note: All items are supplied non-assembled.

Applications

- Standing or hanging installation of pipes and tubes on beams, profiles and consoles
- Design with two threaded ends allows for ideal adaptation to suit the exact outer diameter of the pipe or tube

Diameter Nominal DN	Outside Diameter Pipe / Tube Ø D1 (mm) (in)		Nominal Bore Pipe (in)	Dimensions (mm/in)				
				Round Steel U-Bolt (Type RBD)				
				A	L	H1	H2	Thread G
20	25	.98		30	40	70	40	M10
	26,9	1.06	3/4	1.18	1.57	2.76	1.57	M10
25	30	1.18		38	48	76	40	M10
	33,7	1.33	1	1.50	1.89	2.99	1.57	M10
32	38	1.50		46	56	86	50	M10
	42,4	1.69	1-1/4	1.81	2.20	3.39	1.97	M10
40	44,5	1.76		52	62	92	50	M10
	48,3	1.90	1-1/2	2.05	2.44	3.62	1.97	M10
50	57	2.28		64	76	109	50	M12
	60,3	2.41	2	2.52	2.99	4.29	1.97	M12
65	76,1	3.04	2-1/2	82	94	125	50	M12
80	88,9	3.56	3	94	106	138	50	M12
100	108	4.32		120	136	171	60	M16
	114,3	4.57	4	4.72	5.35	6.73	2.36	M16
125	133	5.32		148	164	191	60	M16
	139,7	5.59	5	5.83	6.46	7.52	2.36	M16
150	159	6.36		176	192	217	60	M16
	168,3	6.73	6	6.93	7.56	8.54	2.36	M16
175	193,7	7.75		202	218	249	60	M16
200	216	8.64		228	248	283	70	M20
	219,1	8.76	8	8.98	9.76	11.14	2.76	M20
250	267	10.68		282	303	334	70	M20
	273	10.92	10	11.10	11.93	13.15	2.76	M20
300	318	12.72		332	352	385	70	M20
	323,9	12.96	12	13.07	13.86	15.16	2.76	M20
350	355,6	14.22	14	378	402	435	70	M24
	368	14.72		14.88	15.83	17.13	2.76	M24
400	406,4	16.26	16	428	452	487	70	M24
	419	16.76		16.85	17.80	19.17	2.76	M24
500	508	20.32	20	530	554	589	70	M24
	521	20.84		20.87	21.81	23.19	2.76	M24

Alternative materials and surface finishings are available upon request. Contact STAUFF for further information.

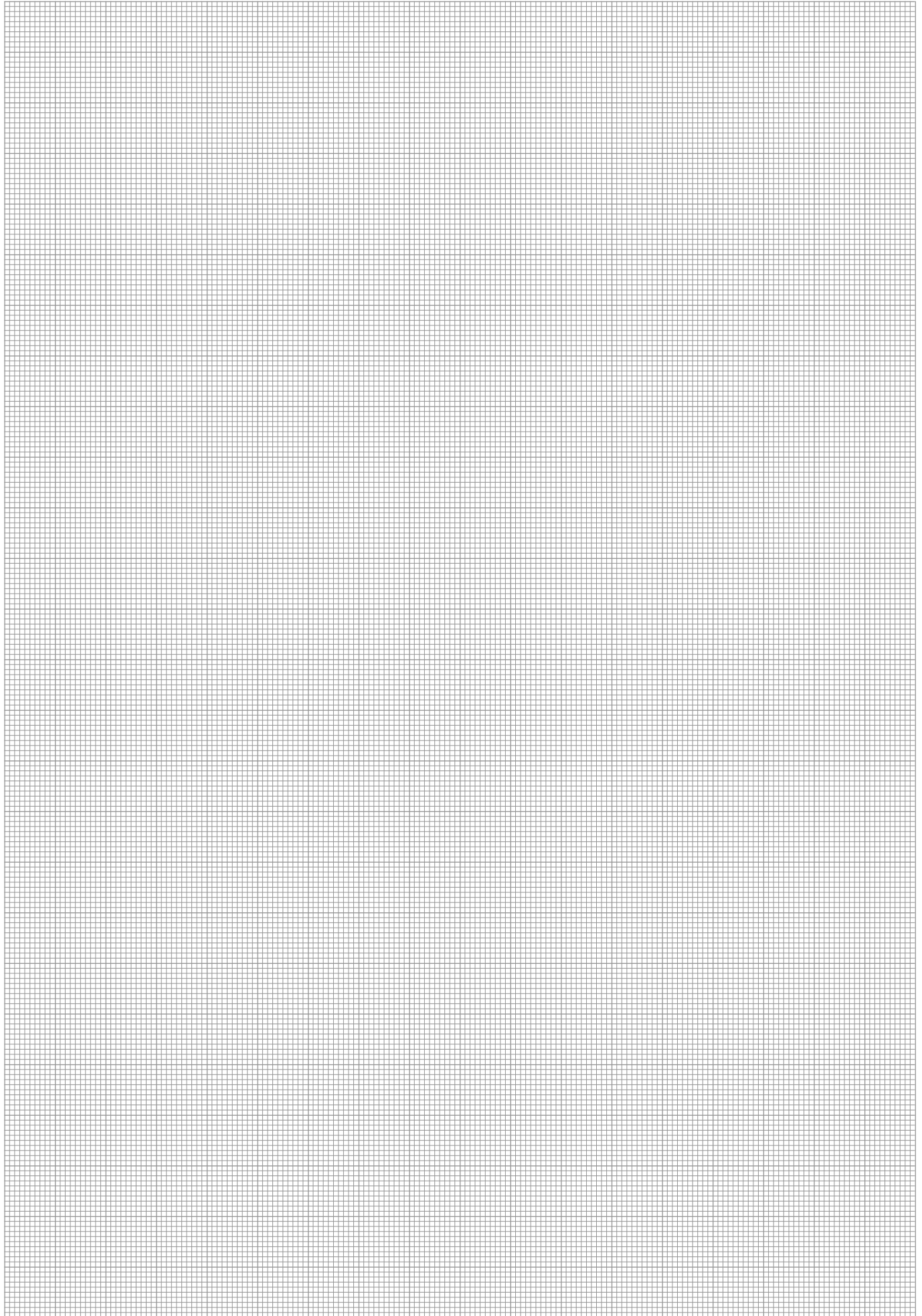

**K**





**Metal Pipe Clamp with Tension Clearance
Two-Bolt Design**
DIN 3567-A

136



**Metal Pipe Clamp with Tension Clearance
Three-Bolt Design (Extended to One Side)**
DIN 3567-B

137



**Heavy Saddle with Tension Clearance
Single-Bolt Design**
DIN 1592

138



**Heavy Saddle with Tension Clearance
Two-Bolt Design**
DIN 1593

139



**Light Saddle with Tension Clearance
Single-Bolt Design**
DIN 1596

140



**Light Saddle with Tension Clearance
Two-Bolt Design**
DIN 1597

141

L



Metal Pipe Clamp with Tension Clearance (DIN 3567-A) Two-Bolt Design

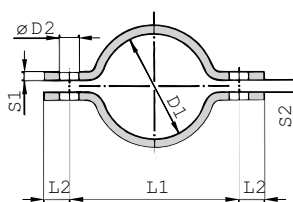

Ordering Codes

Metal Pipe Clamp *DIN3567-A*-20*W1

One metal pipe clamp is consisting of two clamp halves.
Hexagon head bolts and nuts are not included.

* Metal Pipe Clamp to DIN 3567, type A **DIN3567-A**

* STAUFF Group (Ø D1) **-20**

* Material code Carbon Steel, uncoated **W1**

Carbon Steel, hot-dip galvanised **W40**

Stainless Steel V4A **W5**

1.4401 / 1.4571 (AISI 316 / 316 Ti)

Clamp Assembly *DIN3567-A*-20*W1*COMPL

One clamp assembly is consisting of two clamp halves,
two hexagon head bolts and two hexagon head nuts.

* Metal Pipe Clamp to DIN 3567, type A **DIN3567-A**

* STAUFF Group (Ø D1) **-20**

* Material code Carbon Steel, uncoated **W1**

Carbon Steel, hot-dip galvanised **W40**

Stainless Steel V4A **W5**

1.4401 / 1.4571 (AISI 316 / 316 Ti)

* Clamp assembly with bolts and nuts **COMPL**

Please note: All items are supplied non-assembled.

Applications

- Installation of pipes, tubes and other construction elements on beams, profiles and consoles

STAUFF Group	Nominal Size	Dimensions (mm/in)							Accessories
		Pipe (in)	L1	L2	S1	S2	D2	B1	Hexagon Head Bolts (Hexagon Head Nuts)
Ø D1	(mm)		L1	L2	S1	S2	D2	B1	
20	15		57	15	5	7	11.5	30	
			2.24	.59	.20	.28	.45	1.18	
22			59	15	5	7	11.5	30	
				2.32	.59	.20	.28	.45	
25	20		62	15	5	7	11.5	30	
				2.44	.59	.20	.28	.45	
27		3/4	66	15	5	7	11.5	30	
				2.60	.59	.20	.28	.45	
30	25		68	15	5	7	11.5	30	M10 x 30 (M10)
				2.68	.59	.20	.28	.45	
34		1	72	15	5	7	11.5	30	3/8-16 UNC x 1-1/4 (3/8-16 UNC)
				2.83	.59	.20	.28	.45	
38	32		76	15	5	7	11.5	30	
				2.99	.59	.20	.28	.45	
43		1-1/4	82	15	5	7	11.5	30	
				3.23	.59	.20	.28	.45	
45	40		84	15	5	7	11.5	30	
				3.31	.59	.20	.28	.45	
49		1-1/2	88	15	5	7	11.5	30	
				3.46	.59	.20	.28	.45	
57	50		104	18	6	9	14	40	M12 x 35 (M12)
				4.09	.71	.24	.35	.55	
61		2	108	18	6	9	14	40	
				4.25	.71	.24	.35	.55	
77	65	2-1/2	122	18	6	9	14	40	7/16-14 UNC x 1-3/8 (7/16-14 UNC)
				4.80	.71	.24	.35	.55	
89	80	3	136	18	6	9	14	40	
				5.35	.71	.24	.35	.55	
108	100		172	24	8	11	18	50	
				6.77	.94	.31	.43	.71	
115		4	178	24	8	11	18	50	
				7.01	.94	.31	.43	.71	
133	125		196	24	8	11	18	50	
				7.72	.94	.31	.43	.71	
140			204	24	8	11	18	50	M16 x 45 (M16)
				8.03	.94	.31	.43	.71	
159	150		222	24	8	11	18	50	5/8-11 UNC x 1-3/4 (5/8-11 UNC)
				8.74	.94	.31	.43	.71	
169			232	24	8	11	18	50	
				9.13	.94	.31	.43	.71	
194	175		258	24	8	11	18	50	
				10.16	.94	.31	.43	.71	
216	200		280	24	8	11	18	50	
				11.02	.94	.31	.43	.71	
220			284	24	8	11	18	50	
				11.18	.94	.31	.43	.71	
267	250		342	30	8	14	23	60	
				13.46	1.18	.31	.55	.91	
273			348	30	8	14	23	60	M20 x 50 (M20)
				13.70	1.18	.31	.55	.91	
318	300		392	30	8	14	23	60	3/4-10 UNC x 2 (3/4-10 UNC)
				15.43	1.18	.31	.55	.91	
324			398	30	8	14	23	60	
				15.67	1.18	.31	.55	.91	
368	350		444	30	8	14	23	60	
				17.48	1.18	.31	.55	.91	
407	400		498	36	10	18	27	70	M24 x 60 (M24)
				19.61	1.42	.39	.71	1.06	
419			510	36	10	18	27	70	7/8-9 UNC 2-3/8 (7/8-9 UNC)
				10.08	1.42	.39	.71	1.06	
521	500		614	36	10	18	27	70	
				24.17	1.42	.39	.71	1.06	

Alternative materials and surface finishings are available upon request. Contact STAUFF for further information.

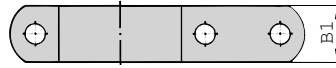
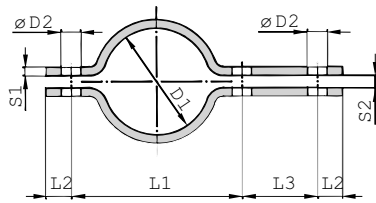

Metal Pipe Clamp with Tension Clearance (DIN 3567-B)
 Three-Bolt Design (Extended to One Side)

STAUFF Group	Nominal Size		Dimensions (mm/m)							Accessories	
	Ø D1	Pipe (in)	L1	L2	L3	S1	S2	D2	B1	Hexagon Head Bolts (Hexagon Head Nuts)	
20	15		57	15	46	5	7	11.5	30	M10 x 30 (M10)	3/8-16 UNC x 1-1/4 (3/8-16 UNC)
22			2.24	.59	1.81	.20	.28	.45	1.18		
25	20	3/4	59	15	46	5	7	11.5	30		
			2.32	.59	1.81	.20	.28	.45	1.18		
27	20	3/4	62	15	46	5	7	11.5	30		
			2.44	.59	1.81	.20	.28	.45	1.18		
30	25	1	66	15	46	5	7	11.5	30		
			2.60	.59	1.81	.20	.28	.45	1.18		
34	25	1	68	15	46	5	7	11.5	30		
			2.68	.59	1.81	.20	.28	.45	1.18		
38	32	1-1/4	72	15	46	5	7	11.5	30		
			2.83	.59	1.81	.20	.28	.45	1.18		
43	32	1-1/4	76	15	46	5	7	11.5	30		
			2.99	.59	1.81	.20	.28	.45	1.18		
45	40	1-1/2	82	15	46	5	7	11.5	30		
			3.23	.59	1.81	.20	.28	.45	1.18		
49	40	1-1/2	84	15	46	5	7	11.5	30		
			3.31	.59	1.81	.20	.28	.45	1.18		
57	50	2	88	15	46	5	7	11.5	30		
			3.46	.59	1.81	.20	.28	.45	1.18		
61	50	2	104	18	54	6	9	14	40		
			4.09	.71	2.13	.24	.35	.55	1.57		
77	65	2-1/2	108	18	54	6	9	14	40		
			4.25	.71	2.13	.24	.35	.55	1.57		
89	80	3	122	18	54	6	9	14	40		
			4.80	.71	2.13	.24	.35	.55	1.57		
108	100	4	136	18	54	6	9	14	40		
			5.35	.71	2.13	.24	.35	.55	1.57		
115	100	4	172	24	70	8	11	18	50		
			6.77	.94	2.76	.31	.43	.71	1.97		
133	125		178	24	70	8	11	18	50		
			7.01	.94	2.76	.31	.43	.71	1.97		
140	125		196	24	70	8	11	18	50		
			7.72	.94	2.76	.31	.43	.71	1.97		
159	150		204	24	70	8	11	18	50		
			8.03	.94	2.76	.31	.43	.71	1.97		
169	150		222	24	70	8	11	18	50		
			8.74	.94	2.76	.31	.43	.71	1.97		
194	175		232	24	70	8	11	18	50		
			9.13	.94	2.76	.31	.43	.71	1.97		
216	200		258	24	70	8	11	18	50		
			10.16	.94	2.76	.31	.43	.71	1.97		
220	200		280	24	70	8	11	18	50		
			11.02	.94	2.76	.31	.43	.71	1.97		
267	250		284	24	70	8	11	18	50		
			11.18	.94	2.76	.31	.43	.71	1.97		
273	250		342	30	86	8	14	23	60		
			13.46	1.18	3.39	.31	.55	.91	2.36		
318	300		348	30	86	8	14	23	60		
			13.70	1.18	3.39	.31	.55	.91	2.36		
324	300		392	30	86	8	14	23	60		
			15.43	1.18	3.39	.31	.55	.91	2.36		
368	350		398	30	86	8	14	23	60		
			15.67	1.18	3.39	.31	.55	.91	2.36		
407	400		444	30	86	8	14	23	60		
			17.48	1.18	3.39	.31	.55	.91	2.36		
419	400		498	36	104	10	18	27	70		
			19.61	1.42	4.09	.39	.71	1.06	2.76		
521	500		510	36	104	10	18	27	70		
			10.08	1.42	4.09	.39	.71	1.06	2.76		
			614	36	104	10	18	27	70		
			24.17	1.42	4.09	.39	.71	1.06	2.76		

Ordering Codes
Metal Pipe Clamp *DIN3567-B*-20*W1

One metal pipe clamp is consisting of two clamp halves. Hexagon head bolts and nuts are not included.

- * Metal Pipe Clamp to DIN 3567, type B **DIN3567-B**
- * STAUFF Group (Ø D1) **-20**
- * Material code Carbon Steel, uncoated **W1**
- Carbon Steel, hot-dip galvanised **W40**
- Stainless Steel V4A **W5**
- 1.4401 / 1.4571 (AISI 316 / 316 Ti)

Clamp Assembly *DIN3567-B*-20*W1*COMPL

One clamp assembly is consisting of two clamp halves, three hexagon head bolts and three hexagon head nuts.

- * Metal Pipe Clamp to DIN 3567, type B **DIN3567-B**
- * STAUFF Group (Ø D1) **-20**
- * Material code Carbon Steel, uncoated **W1**
- Carbon Steel, hot-dip galvanised **W40**
- Stainless Steel V4A **W5**
- 1.4401 / 1.4571 (AISI 316 / 316 Ti)
- * Clamp assembly with bolts and nuts **COMPL**

Please note: All items are supplied non-assembled.

Applications

- Installation of pipes, tubes and other construction elements on beams, profiles and consoles

Alternative materials and surface finishings are available upon request. Contact STAUFF for further information.



Heavy Saddle with Tension Clearance (DIN 1592) Single-Bolt Design

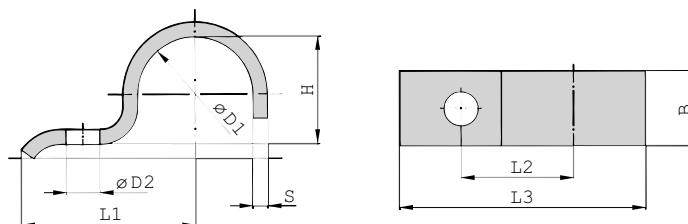

Ordering Codes

Heavy Saddle

***DIN1592-*7-*W66**

* Heavy Saddle to DIN 1592

DIN1592

* STAUFF Group (Ø D1)

7

* Material code Carbon Steel, uncoated

W1

Carbon Steel, zinc-plated
and thick-film passivated

W66

Stainless Steel V4A
1.4401 / 1.4571 (AISI 316 / 316 Ti)

W5

Applications

- Installation of pipes, tubes, poles and other round components directly on the substrate (floor, wall or ceiling)

STAUFF Group	Diameter Range		Dimensions (mm/in)						
	Ø D1 (mm)	(in)	L1	L2	L3	H	D2	B	S
7	5,5 ... 7	.2228	22	14	27,5	5	6,6	16	2
			.87	.55	1.08	.20	.26	.63	.08
9	7 ... 9	.2835	27	18	33,5	6	6,6	20	2
			1.06	.71	1.32	.24	.26	.79	.08
13	9,5 ... 13	.3951	40	25	49,5	9	11	25	3
			1.57	.98	1.95	.35	.43	.98	.12
15,5	13 ... 15,5	.5161	41	26	52	12	11	25	3
			1.61	1.02	2.05	.47	.43	.98	.12
19	15,5 ... 19	.6175	43	28	55,5	15	11	25	3
			1.69	1.10	2.19	.59	.43	.98	.12
23	20 ... 23	.7991	51	35	67	19	14	30	5
			2.01	1.38	2.64	.75	.55	1.18	.20
26	23 ... 26	.91 ... 1.02	52	36	70	22	14	30	5
			2.05	1.42	2.76	.87	.55	1.18	.20
28,5	26 ... 28,5	1.02 ... 1.12	53	37	73	24	14	30	5
			2.09	1.46	2.87	.94	.55	1.18	.20
31	28,5 ... 31	1.12 ... 1.22	55	39	75,5	27	14	30	5
			2.17	1.54	2.97	1.06	.55	1.18	.20
36	33 ... 36	1.30 ... 1.42	57	41	81	32	14	40	5
			2.24	1.61	3.19	1.26	.55	1.57	.20
39	36 ... 39	1.42 ... 1.54	59	43	83,5	34	14	40	5
			2.32	1.69	3.29	1.34	.55	1.57	.20
43	39 ... 43	1.54 ... 1.69	68	48	94,5	38	18	40	5
			2.68	1.89	3.72	1.50	.71	1.57	.20
46	43 ... 46	1.69 ... 1.81	70	50	98	41	18	40	5
			2.76	1.97	3.86	1.61	.71	1.57	.20
49	46 ... 49	1.81 ... 1.93	73	53	105,5	44	18	40	8
			2.87	2.09	4.15	1.73	.71	1.57	.31
52 *	49 ... 52	1.93 ... 2.05	76	56	110	47	18	40	8
			2.99	2.20	4.33	1.85	.71	1.57	.31
58	53 ... 58	2.09 ... 2.28	78	58	115	52	18	40	8
			3.07	2.28	4.53	2.05	.71	1.57	.31
61	58 ... 61	2.28 ... 2.40	80	60	118,5	57	18	40	8
			3.15	2.36	4.67	2.24	.71	1.57	.31

* Similar to DIN 1592.

Alternative materials and surface finishings are available upon request. Contact STAUFF for further information.



Heavy Saddle with Tension Clearance (DIN 1593) Two-Bolt Design

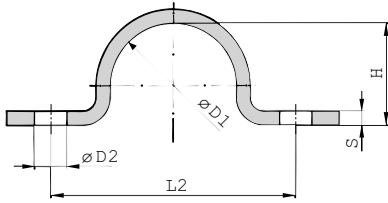

STAUFF Group	Diameter Range		Dimensions (mm/in)						
	Ø D1 (mm)	(in)	L1	L2	H	D2	B	S	
7	5,5 ... 7	.2228	44	28	5	6,6	16	2	
			1.73	1.10	.20	.26	.63	.08	
9	7 ... 9	.2835	48	32	6	6,6	20	2	
			1.89	1.26	.24	.26	.79	.08	
13	9,5 ... 13	.3951	52	36	9	6,6	20	2	
			2.05	1.42	.35	.26	.79	.08	
15,5	13 ... 15,5	.5161	56	40	12	6,6	20	2	
			2.20	1.57	.47	.26	.79	.08	
19	15,5 ... 19	.6175	60	44	15	6,6	20	2	
			2.36	1.73	.59	.26	.79	.08	
23	20 ... 23	.7991	82	56	19	11	25	3	
			3.23	2.20	.75	.43	.98	.12	
26	23 ... 26	.91 ... 1.02	84	58	22	11	25	3	
			3.31	2.28	.87	.43	.98	.12	
28,5	26 ... 28,5	1.02 ... 1.12	90	64	24	11	25	3	
			3.54	2.52	.94	.43	.98	.12	
31	28,5 ... 31	1.12 ... 1.22	90	64	27	11	25	3	
			3.54	2.52	1.06	.43	.98	.12	
36	33 ... 36	1.30 ... 1.42	106	80	32	11	30	5	
			4.17	3.15	1.26	.43	1.18	.20	
39	36 ... 39	1.42 ... 1.54	110	84	34	11	30	5	
			4.33	3.31	1.34	.43	1.18	.20	
43	39 ... 43	1.54 ... 1.69	120	88	38	14	30	5	
			4.72	3.46	1.50	.55	1.18	.20	
46	43 ... 46	1.69 ... 1.81	122	90	41	14	30	5	
			4.80	3.54	1.61	.55	1.18	.20	
49	46 ... 49	1.81 ... 1.93	122	90	44	14	30	5	
			4.80	3.54	1.73	.55	1.18	.20	
58	53 ... 58	2.09 ... 2.28	142	110	52	14	40	5	
			5.59	4.33	2.05	.55	1.57	.20	
61	58 ... 61	2.28 ... 2.40	142	110	57	14	40	5	
			5.59	4.33	2.24	.55	1.57	.20	
71	67 ... 71	2.64 ... 2.80	152	120	66	14	40	5	
			5.98	4.72	2.60	.55	1.57	.20	
77	73 ... 77	2.87 ... 3.03	176	136	72	18	40	5	
			6.93	5.35	2.83	.71	1.57	.20	
81	77 ... 81	3.03 ... 3.19	184	144	76	18	40	5	
			7.24	5.67	2.99	.71	1.57	.20	
91	88 ... 91	3.39 ... 3.58	198	158	85	18	40	8	
			7.80	6.22	3.35	.71	1.57	.31	
103	99 ... 103	3.90 ... 4.06	214	174	98	18	40	8	
			8.43	6.85	3.86	.71	1.57	.31	
109	105 ... 109	4.13 ... 4.29	220	180	104	18	40	8	
			8.66	7.09	4.09	.71	1.57	.31	
115	110 ... 115	4.33 ... 4.53	226	186	109	18	40	8	
			8.90	7.32	4.29	.71	1.57	.31	

Ordering Codes

Heavy Saddle

***DIN1593-7-*W66**

* Heavy Saddle to DIN 1593

DIN1593

* STAUFF Group (Ø D1)

7

* Material code Carbon Steel, uncoated

W1

Carbon Steel, zinc-plated
and thick-film passivated

W66

Stainless Steel V4A

1.4401 / 1.4571 (AISI 316 / 316 Ti) **W5**

Applications

- Installation of pipes, tubes, poles and other round components directly on the substrate (floor, wall or ceiling)

Alternative materials and surface finishings are available upon request. Contact STAUFF for further information.



Light Saddle with Tension Clearance (DIN 1596) Single-Bolt Design

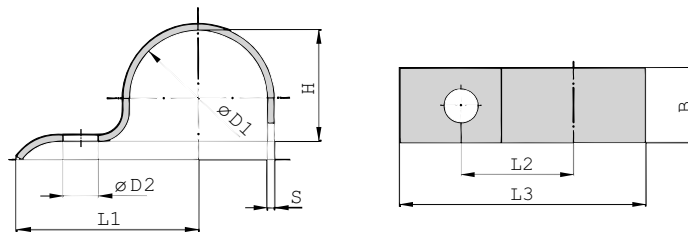

Ordering Codes

Light Saddle

***DIN1596-*7-*W66**

* Light Saddle to DIN 1596	DIN1596
* STAUFF Group (Ø D1)	7
* Material code	W1
Carbon Steel, uncoated	
Carbon Steel, zinc-plated and thick-film passivated	W66
Stainless Steel V4A	
1.4401 / 1.4571 (AISI 316 / 316 Ti)	W5

Applications

- Installation of pipes, tubes, poles and other round components directly on the substrate (floor, wall or ceiling)

STAUFF Group	Diameter Range		Dimensions (mm/in)						
	Ø D1 (mm)	(in)	L1	L2	L3	H	D2	B	S
7	5,5 ... 7	.2228	26	14	31,5	5	6,6	16	2
			1.02	.55	1.24	.20	.26	.63	.08
9	7 ... 9	.2835	28	16	34,5	6	6,6	16	2
			1.10	.63	1.36	.24	.26	.63	.08
13	9,5 ... 13	.3951	30	18	38,5	9	6,6	20	2
			1.18	.71	1.52	.35	.26	.79	.08
15,5	13 ... 15,5	.5161	32	20	41,75	12	6,6	20	2
			1.26	.79	1.64	.47	.26	.79	.08
19	15,5 ... 19	.6175	34	22	45,5	15	6,6	20	2
			1.34	.87	1.79	.59	.26	.79	.08
23	20 ... 23	.7991	43	28	57,5	19	9	25	3
			1.69	1.10	2.26	.75	.35	.98	.12
26	23 ... 26	.91 ... 1.02	44	29	60	22	9	25	3
			1.73	1.14	2.36	.87	.35	.98	.12
28,5	26 ... 28,5	1.02 ... 1.12	47	32	64,25	24	9	25	3
			1.85	1.26	2.53	.94	.35	.98	.12
31	28,5 ... 31	1.12 ... 1.22	47	32	65,5	27	9	25	3
			1.85	1.26	2.58	1.06	.35	.98	.12
33 *	31 ... 33	1.22 ... 1.30	56	36	75,5	29	9	25	3
			2.20	1.42	2.97	1.14	.35	.98	.12
36	33 ... 36	1.30 ... 1.42	57	40	78	32	11	30	3
			2.24	1.57	3.07	1.26	.43	1.18	.12
39	36 ... 39	1.42 ... 1.54	59	42	81,5	34	11	30	3
			2.32	1.65	3.21	1.34	.43	1.18	.12
43	39 ... 43	1.54 ... 1.69	61	44	85,5	38	11	30	3
			2.40	1.73	3.37	1.50	.43	1.18	.12
46	43 ... 46	1.69 ... 1.81	62	45	88	41	11	30	3
			2.44	1.77	3.46	1.61	.43	1.18	.12
49	46 ... 49	1.81 ... 1.93	67	48	95,5	44	14	40	4
			2.64	1.89	3.76	1.73	.55	1.57	.16
52 *	49 ... 52	1.93 ... 2.05	72	53	102	47	14	40	4
			2.83	2.09	4.02	1.85	.55	1.57	.16
58	53 ... 58	2.09 ... 2.28	76	55	107	52	14	40	4
			2.99	2.17	4.21	2.05	.55	1.57	.16
61	58 ... 61	2.28 ... 2.40	77	58	111,5	56	14	40	4
			3.03	2.28	4.39	2.20	.55	1.57	.16

* Similar to DIN 1596.

Alternative materials and surface finishings are available upon request. Contact STAUFF for further information.

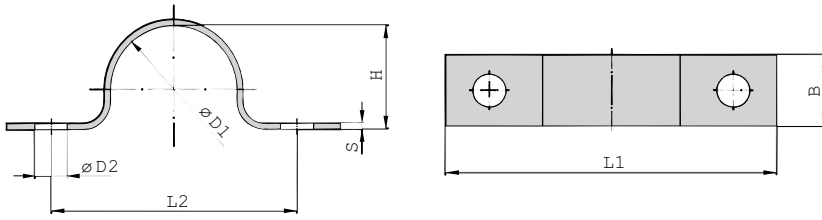

Light Saddle with Tension Clearance (DIN 1597)
 Two-Bolt Design

STAUFF Group	Diameter Range		Dimensions (mm/in)						
	Ø D1	(mm)	(in)	L1	L2	H	D2	B	S
7	5,5 ... 7	.2228	44	28	5	5,5	16	1,5	
			1.73	1.10	.20	.22	.63	.06	
9	7 ... 9	.2835	48	32	6	5,5	16	1,5	
			1.89	1.26	.24	.22	.63	.06	
13	9,5 ... 13	.3951	52	36	9	5,5	16	1,5	
			2.05	1.42	.35	.22	.63	.06	
15,5	13 ... 15,5	.5161	56	40	12	5,5	16	1,5	
			2.20	1.57	.47	.22	.63	.06	
19	15,5 ... 19	.6175	60	44	15	5,5	16	1,5	
			2.36	1.73	.59	.22	.63	.06	
23	20 ... 23	.7991	76	56	19	6,6	20	2	
			2.99	2.20	.75	.26	.79	.08	
26	23 ... 26	.91 ... 1.02	78	58	22	6,6	20	2	
			3.07	2.28	.87	.26	.79	.08	
28,5	26 ... 28,5	1.02 ... 1.12	84	64	24	6,6	20	2	
			3.31	2.52	.94	.26	.79	.08	
31	28,5 ... 31	1.12 ... 1.22	84	64	27	6,6	20	2	
			3.31	2.52	1.06	.26	.79	.08	
33 *	31 ... 33	1.22 ... 1.30	92	72	29	6,6	20	2	
			3.62	2.83	1.14	.26	.79	.08	
36	33 ... 36	1.30 ... 1.42	104	80	32	9	25	3	
			4.09	3.15	1.26	.35	.98	.12	
39	36 ... 39	1.42 ... 1.54	108	84	34	9	25	3	
			4.25	3.31	1.34	.35	.98	.12	
43	39 ... 43	1.54 ... 1.69	112	88	38	9	25	3	
			4.41	3.46	1.50	.35	.98	.12	
46	43 ... 46	1.69 ... 1.81	114	90	41	9	25	3	
			4.49	3.54	1.61	.35	.98	.12	
49	46 ... 49	1.81 ... 1.93	118	90	44	11	30	3	
			4.65	3.54	1.73	.43	1.18	.12	
52 *	49 ... 52	1.93 ... 2.05	134	106	47	11	30	3	
			5.28	4.17	1.85	.43	1.18	.12	
58	53 ... 58	2.09 ... 2.28	138	110	52	11	30	3	
			5.43	4.33	2.05	.43	1.18	.12	
61	58 ... 61	2.28 ... 2.40	138	110	56	11	30	3	
			5.43	4.33	2.20	.43	1.18	.12	

Ordering Codes
Light Saddle
***DIN1597-7-*W66**

* Light Saddle to DIN 1597	DIN 1597
* STAUFF Group (Ø D1)	7
* Material code	Carbon Steel, uncoated W1
	Carbon Steel, zinc-plated and thick-film passivated W66
	Stainless Steel V4A W5
	1.4401 / 1.4571 (AISI 316 / 316 Ti)

Applications



- Installation of pipes, tubes, poles and other round components directly on the substrate (floor, wall or ceiling)

* Similar to DIN 1597.

Alternative materials and surface finishings are available upon request. Contact STAUFF for further information.





	Construction Series KS / DKS	144
	Construction Series (for Anchor Bolt Fastening) KSV / DKSV	145



Construction Series
Types KS (Single Version) / DKS (Double Version)

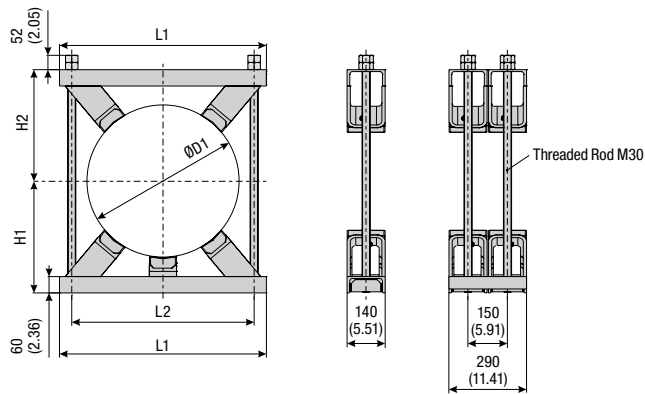
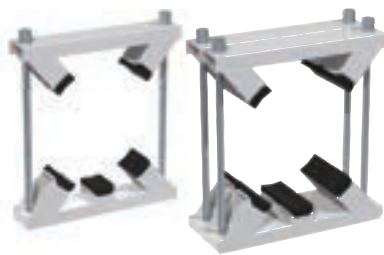

Ordering Codes

Construction Series ***KS-*220-*PA-*W8**

* Version Single version **KS**
 Double version **DKS**

* Exact outside diameter ØD1 (mm) **220**

* Material of Plastic Pads (see below) **PA**

* Material Code Steel, prime coated (grey, RAL 7035) **W8**

Please note: All items are supplied non-assembled.

Standard Materials for Plastic Pads



See pages 154 / 155 for material properties and technical information.

Group	Outside Diameter ØD1 Pipe / Tube		Standard Diameters		Dimensions (mm/in)				No. of Plastic Pads		
	STAUFF	(mm)	(in)	(mm)	(in)	L1	L2	H1		H2	
1	220 ... 275	8.66 ... 10.85	220	8.66	420	16.54	330	12.99	220	8.66	4
			247	9.72							
			267	10.51							
			273	10.75							
			280	11.02							
2	276 ... 325	10.87 ... 12.80	300	11.81	460	18.11	370	14.57	240	9.45	4
			318	12.52							
			323,9	12.75							
			355,6	14.00							
3	326 ... 370	12.83 ... 14.57	368	14.49	510	20.08	420	16.53	260	10.23	4
			390	15.35							
4	371 ... 425	14.61 ... 16.73	406,4	16.00	570	22.44	480	18.89	290	11.42	4
			457,2	18.00							
5	426 ... 485	16.77 ... 19.09	470	18.50	620	24.41	530	20.87	305	12.01	4
			490	19.29							
6	486 ... 550	19.13 ... 21.65	508	20.00	680	26.77	590	23.23	370	14.57	4
			521	20.51							
			546	21.50							
			558,8	22.00							
7	551 ... 630	21.69 ... 24.80	609,6	24.00	760	29.92	670	26.38	410	16.14	5
			711	28.00							
8	631 ... 715	24.84 ... 28.15	845	33.27	845	33.27	755	29.72	452	17.80	5
			940	37.00							
9	716 ... 800	28.19 ... 31.50	990	38.97	940	37.00	850	33.46	495	19.49	5
			1000	39.37							
10	813	32.00	1200	47.24	990	38.97	900	35.43	500	19.69	5
			1016	40.00							
11	1000	39.37	1200	47.24	1200	47.24	1100	43.30	591,5	23.29	5
			1016	40.00							
12	1016	40.00	1200	47.24	1200	47.24	1100	43.30	602	23.70	5
			1016	40.00							

Alternative outside diameters, materials and surface finishings are available upon request. Contact STAUFF for further information.

Dimensional drawings: All dimensions in mm (in).

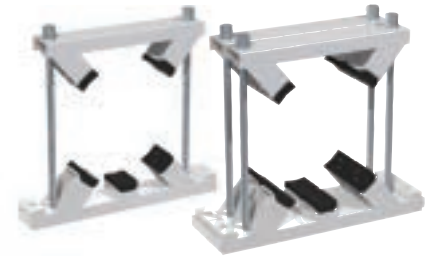
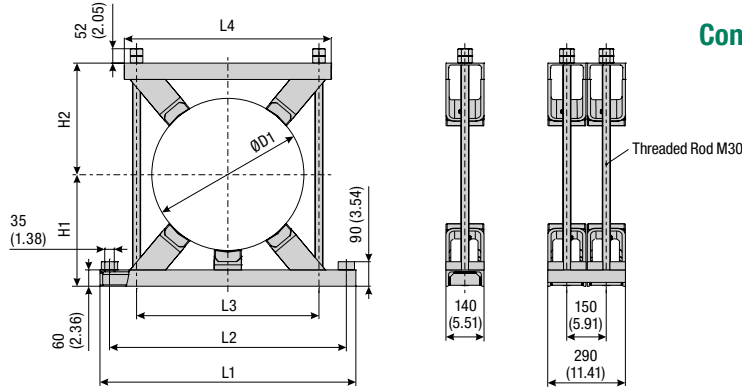

Construction Series for Anchor Bolt Fastening Types KSV (Single) / DKSV (Double)

Group STAUFF	Outside Diameter ØD1 Pipe / Tube Diameter Range		Standard Diameters		Dimensions (mm/in)						No. of Plastic Pads
	(mm)	(in)	(mm)	(in)	L1	L2	L3	L4	H1	H2	
1	220 ... 275	8.66 ... 10.85	220	8.66	580	490	330	420	220	220	4
			247	9.72							
			267	10.51							
			273	10.75							
2	276 ... 325	10.87 ... 12.80	280	11.02	620	530	370	460	240	240	4
			300	11.81							
			318	12.52							
			323,9	12.75							
3	326 ... 370	12.83 ... 14.57	355,6	14.00	670	580	420	510	260	260	4
			368	14.49							
4	371 ... 425	14.61 ... 16.73	390	15.35	750	640	480	570	290	290	4
			406,4	16.00							
5	426 ... 485	16.77 ... 19.09	457,2	18.00	800	730	530	620	305	305	4
			470	18.50							
6	486 ... 550	19.13 ... 21.65	490	19.29	860	790	590	680	370	370	4
			508	20.00							
			521	20.51							
			546	21.50							
7	551 ... 630	21.69 ... 24.80	558,8	22.00	940	870	670	760	410	410	5
			609,6	24.00							
8	631 ... 715	24.84 ... 28.15	711	28.00	1025	955	755	845	452	452	5
					40.31	37.60	29.72	33.27	17.80	17.80	
9	716 ... 800	28.19 ... 31.50	762	30.00	1120	1050	850	940	495	495	5
					44.09	41.33	33.46	37.00	19.49	19.49	
10			813	32.00	1170	1100	900	990	500	500	5
					46.06	43.30	35.43	38.97	19.69	19.69	
11			1000	39.37	1400	1300	1100	1200	591,5	593	5
					55.12	51.18	43.30	47.24	23.29	23.34	
12			1016	40.00	1400	1300	1100	1200	602	602	5
					55.12	51.18	43.30	47.24	23.70	23.70	

Ordering Codes
Construction Series *KSV-*220-*PA-*W8

* Version Single version **KSV**
 Double version **DKSV**

* Exact outside diameter ØD1 (mm) **220**

* Material of Plastic Pads (see below) **PA**

* Material Code Steel, prime coated (grey, RAL 7035) **W8**

Please note: All items are supplied non-assembled.

Standard Materials for Plastic Pads

Polyamide
 Colour: Black
 Material Code: **PA**

See pages 154 / 155 for material properties and technical information.

Alternative outside diameters, materials and surface finishings are available upon request. Contact STAUFF for further information.







Cushion Clamp Series

STC / SPC

148



Channel Rail

SCS

149



Compact Twin Series

DS

150



Agriculture Twin Series

AG

150



Pipe / Tube Bushing

RF

151



Clamp Assembly - Types STC / SPC

(for Use with Channel Rail SCS)

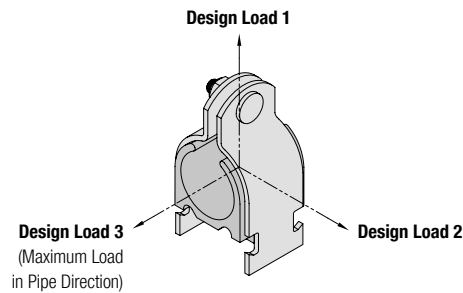
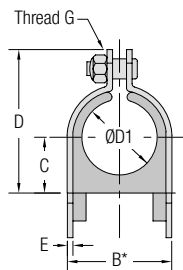
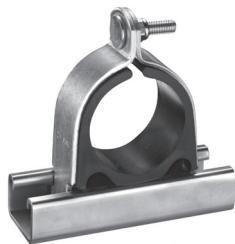

Outside Diameter Pipe / Tube / Hose Ø D1 (mm) (in)		Nominal Bore Pipe (in)	Ordering Codes (1 Clamp Assembly) (*** = Material Code)	Standard Packaging Units pcs.	Dimensions (mm/in)					Thread G	Design Loads (kN/psi)		
					B*	C	D	E		1	2	3	
6,4	1/4		STC-025-***-K	24 / box	15,7	5,6	28,2	2	1/4-20 UNC	1,78	0,22	0,22	
					.62	.22	1.11	.08		400	50	50	
8	3/8		STC-037-***-K	24 / box	19,1	7,1	31,5	2	1/4-20 UNC	1,78	0,22	0,22	
					.75	.28	1.24	.08		400	50	50	
12,7	1/2		STC-050-***-K	24 / box	22,1	8,6	34,5	2	1/4-20 UNC	1,78	0,22	0,22	
					.87	.34	1.36	.08		400	50	50	
13,5		1/4	SPC-025-***-K	24 / box	23,1	9,1	35,8	2	1/4-20 UNC	1,78	0,22	0,22	
					.91	.36	1.41	.08		400	50	50	
16	5/8		STC-062-***-K	24 / box	25,4	10,4	38,1	2	1/4-20 UNC	1,78	0,22	0,22	
					1.00	.41	1.50	.08		400	50	50	
17,2		3/8	SPC-037-***-K	24 / box	27,2	11,4	40,4	2	1/4-20 UNC	2,67	0,33	0,33	
					1.07	.45	1.59	.08		600	75	75	
19	3/4		STC-075-***-K	24 / box	33,8	13,5	45,2	2	1/4-20 UNC	2,67	0,33	0,33	
					1.33	.53	1.78	.08		600	75	75	
21,3		1/2	SPC-050-***-K	24 / box	36,8	15,0	48,5	2	1/4-20 UNC	2,67	0,33	0,33	
					1.45	.59	1.91	.08		600	75	75	
22,2	7/8		STC-087-***-K	24 / box	36,8	14,7	48,5	2	1/4-20 UNC	2,67	0,33	0,33	
					1.45	.58	1.91	.08		600	75	75	
25,4	1		STC-100-***-K	12 / box	42,2	16,8	51,6	2,8	1/4-20 UNC	2,67	0,33	0,33	
					1.66	.66	2.03	.11		600	75	75	
26,9		3/4	SPC-075-***-K	12 / box	45,5	18,3	54,9	2,8	1/4-20 UNC	2,67	0,33	0,33	
					1.79	.72	2.16	.11		600	75	75	
32	1-1/4		STC-125-***-K	12 / box	48,8	19,8	58,4	2,8	1/4-20 UNC	2,67	0,33	0,33	
					1.92	.78	2.30	.11		600	75	75	
33,7		1	SPC-100-***-K	12 / box	56,4	23,1	69,9	3	5/16-18 UNC	2,67	0,33	0,33	
					2.22	.91	2.75	.12		600	75	75	
38	1-1/2		STC-150-***-K	12 / box	56,4	23,1	69,9	3	5/16-18 UNC	2,67	0,33	0,33	
					2.22	.91	2.75	.12		600	75	75	
42		1-1/4	SPC-125-***-K	12 / box	62,7	26,2	77,0	3	5/16-18 UNC	3,56	0,56	0,56	
					2.47	1.03	3.03	.12		800	125	125	
48,3		1-1/2	SPC-150-***-K	12 / box	62,7	29,5	83,3	3	5/16-18 UNC	3,56	0,56	0,56	
					2.47	1.16	3.28	.12		800	125	125	
50,8	2		STC-200-***-K	12 / box	69,1	29,5	83,3	3	5/16-18 UNC	3,56	0,56	0,56	
					2.72	1.16	3.28	.12		800	125	125	
60,3		2	SPC-200-***-K	1 / bag	69,1	35,8	96,0	3	5/16-18 UNC	3,56	0,56	0,56	
					3.22	1.41	3.78	.12		800	125	125	
63,5	2-1/2		STC-250-***-K	1 / bag	88,1	38,9	102,4	3	5/16-18 UNC	3,56	0,56	0,56	
					3.47	1.53	4.03	.12		800	125	125	
66,7	2-5/8		STC-262-***-K	1 / bag	88,1	38,9	102,4	3	5/16-18 UNC	3,56	0,56	0,56	
					3.47	1.53	4.03	.12		800	125	125	
73		2-1/2	SPC-250-***-K	1 / bag	94,5	42,2	108,5	3	5/16-18 UNC	3,56	0,56	0,56	
					3.72	1.66	4.27	.12		800	125	125	
76,2	3		STC-300-***-K	1 / bag	100,8	45,2	114,8	3	5/16-18 UNC	4,45	0,89	0,67	
					3.97	1.78	4.52	.12		1 000	200	150	
88,9		3	SPC-300-***-K	1 / bag	110,7	50,0	124,7	3	3/8-16 UNC	4,45	0,89	0,67	
					4.36	1.97	4.91	.12		1 000	200	150	
102		3-1/2	SPC-350-***-K	1 / bag	126,2	57,9	140,5	3	3/8-16 UNC	4,45	0,89	0,67	
					4.97	2.28	5.53	.12		1 000	200	150	
114		4	SPC-400-***-K	1 / bag	138,9	64,3	153,2	3	3/8-16 UNC	4,45	0,89	0,67	
					5.47	2.53	6.03	.12		1 000	200	150	
140		5	SPC-500-***-K	1 / bag	164,3	77,0	178,6	3,6	3/8-16 UNC	4,45	0,89	0,67	
					6.47	3.03	7.03	.14		1 000	200	150	
168		6	SPC-600-***-K	1 / bag	189,7	89,7	204,0	3,6	3/8-16 UNC	4,45	0,89	0,67	
					7.47	3.53	8.03	.14		1 000	200	150	

* Minimum required for installation.

One clamp assembly is consisting of two carbon steel clamp halves (one with threaded stud), one thermoplastic cushion insert and one lock nut with Nylon insert. Channel rail not included. All threaded parts are only available with unified coarse (UNC) thread. Alternative materials and surface finishings are available upon request. Contact STAUFF for further information.



Clamp Assembly ■ Types STC / SPC
(for Use with Channel Rail SCS)

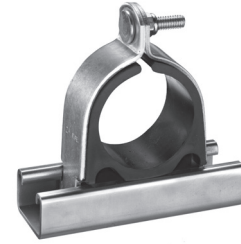
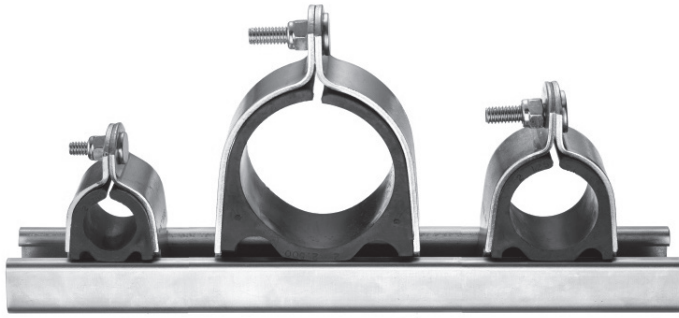

Standard Materials



Cushion Insert
Thermoplastic Elastomer (80 Shore-A)
Colour: Black

The cushion material is compatible with most oils, chemicals and cleaning solvents and suitable for applications within a temperature range of -50 °C ... +125 °C (-58 °F ... +257 °F).

Alternative materials are available upon request.
Please contact STAUFF for further information.

Product Features

- Clamp assemblies designed to mount directly to 41,3 mm / 1-5/8 in wide strut channels, such as the STAUFF Channel Rail, type SCS
- Suitable for most Fluid Power applications ranging from mobile equipment to industrial machinery
- Reduced horizontal mounting space
- Easy installation and retro fit capability
- Reduces shock and vibration while preventing galvanic corrosion

Ordering Codes

Clamp Assembly		*STC-*125-*W4-*K
* Type of clamp	STC (Tube diameters) SPC (Pipe diameters)	STC SPC
* Pipe / Tube O.D. (according to dimension table)		125
* Material code	Carbon Steel, zinc-plated, blue-chromated	W32
	Stainless Steel V2A 1.4301 (AISI 304)	W4
	Stainless Steel V4A 1.4401 (AISI 316)	W5
Assembling	Components packed in kits	K

Channel Rail ■ Type SCS

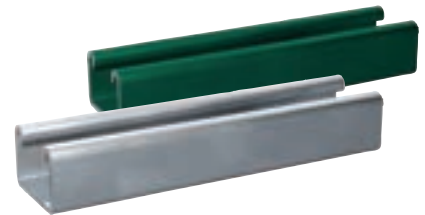
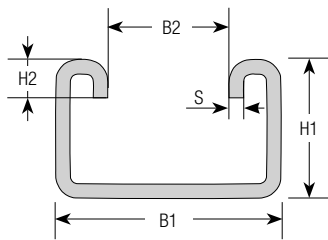

Dimensions (mm/in)				
B1	B2	H1	H2	S
41,3	22,2	25,4	7	2,7
1.63 (1-5/8)	.88 (7/8)	1.00	.28	.11

Alternative rail profiles, materials and surface finishings are available upon request. Contact STAUFF for further information.

Ordering Codes

Strut Channel		*SCS-*048-*1-*PL
* Strut Channel		SCS
* Length of Rail	1,22 m / 4.00 ft / 48 in 3,05 m / 10.00 ft / 120 in	048 120
* Height of Rail	25,4 mm / 1.00 in	1
* Material code	Carbon Steel, uncoated Carbon Steel, green painted	PL GR

N



Compact Twin Series: Clamp Body Type DS

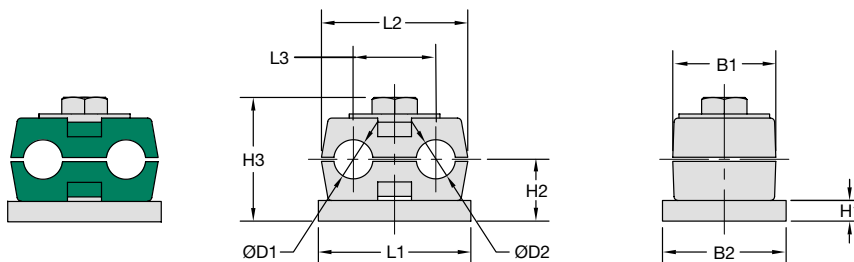

Ordering Codes

Clamp Body *1-*06/06-*PP-*DS

One clamp body is consisting of two clamp halves.

- * STAUFF Group DS 1 **1**
- * Exact outside diameters Ø D1 / Ø D2 (mm) **06/06**
- * Clamp Body Material (Polypropylene) **PP**
- * Compact Twin Series **DS**

Group	Outside Diameter Pipe / Tube Ø D1 / Ø D2		Nominal Bore Pipe Copper Tube ASTM B88		Ordering Codes (2 Clamp Halves)	Dimensions (mm/in)										
	(mm)	(in)	(in)	(in)		L1	L2	L3	H1	H2	H3	B1	B2			
STAUFF DS 1	6				106/06-PP-DS											
	6,4	1/4			106.4/06.4-PP-DS											
	8	5/16			108/08-PP-DS	37	35,5	20	5	15	30	25	30			
	9,5	3/8		1/4	109.5/09.5-PP-DS	1.46	1.40	.79	.20	.59	1.18	.98	1.18			
	10		1/8		110/110-PP-DS											

Additional outside diameters are available upon request. Please contact STAUFF for further information.

Compact Twin Series: Metal Hardware

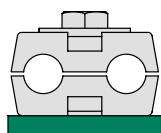

Weld Plate, Type SP-DS

SP-DS-1-U-W2
Thread size: 1/4–20 UNC
Carbon Steel, phosphated

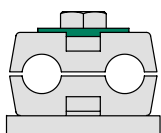

Cover Plate, Type US-DS

US-DS-1-W3
Carbon Steel, zinc/nickel-plated

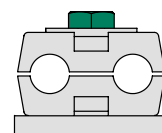

Hexagon Bolt, Type AS

AS-1/4-20UNCx1-W3
Thread size: 1/4–20 UNC
Carbon Steel, zinc/nickel-plated

All threaded parts are only available with unified coarse (UNC) thread. Rail mount and stacking assemblies as well as alternative materials and surface finishings are available upon request.

Agriculture Twin Series: Clamp Body Type AG

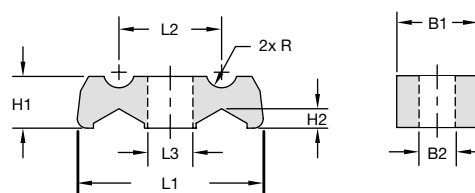
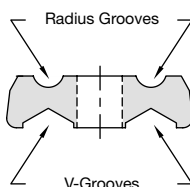

Group	Min/Max Outside Diameters Pipe / Tube				Ordering Codes (1 Clamp Body)	Dimensions (mm/in)							
	Radius Grooves		V-Grooves			L1	L2	L3	H1	H2	B1	B2	R
2	3 ... 10	.1239	4 ... 15	.2659	215.8/09.6-PP-AG-BK-HV	57,5 2.26	31,7 1.25	14,0 .55	16,0 .63	7,1 .24	25,0 .98	11,0 .43	4,8 .19
3	4 ... 25	.1698	7 ... 20	.2879	324.8/19.5-PP-AG-BK-HV	62,0 2.48	34,5 1.36	14,0 .55	19,0 .75	7,1 .28	32,0 1.26	11,0 .43	12,4 .49

Standard Material



Polypropylene
Colour: Black

See pages 154 / 155 for properties and technical information.

Product Features

- Flip the clamp body to choose between the radius grooved or the v-grooved design (suitable for a range of diameters)
- Use M10 or 3/8–16 UNC bolts or screws (preferably with washers) to fasten clamp bodies directly to the machine
- Clamp bodies can be stacked for multi-level assembly

Additional outside diameters are available upon request. Please contact STAUFF for further information.



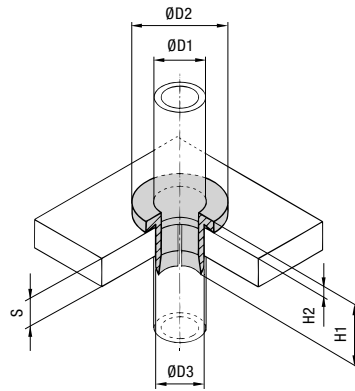

Pipe / Tube Bushing - Type SRF



Outside Diameter ØD1		Nominal Bore (in)	Dimensions (mm/in)			Wall Thickness (mm/in)		Mounting Bore (mm/in)
(mm)	(in)		ØD2	H1	H2	S		
6	1/4		18	22	4	4 ... 12	10	
			.71	.87	.16	.1647	.39	
8	5/16		20	22	4	4 ... 12	12	
			.79	.87	.16	.1647	.47	
10	3/8	1/8 Pipe 1/4 Copper Tube (ASTM B88)	22	22	4	4 ... 12	14	
			.87	.87	.16	.1647	.55	
12	1/2	3/8 Copper Tube (ASTM B88)	24	22	4	4 ... 12	16	
			.94	.87	.16	.1647	.63	
14		1/4 Pipe	26	22	4	4 ... 12	18	
			1.02	.87	.16	.1647	.71	
15			28	22	4	4 ... 12	20	
			1.10	.87	.16	.1647	.79	
16	5/8	1/2 Copper Tube (ASTM B88)	28	22	4	4 ... 12	20	
			1.10	.87	.16	.1647	.79	
18			30	22	4	4 ... 12	22	
			1.18	.87	.16	.1647	.87	
20	3/4		32	22	4	4 ... 12	24	
			1.26	.87	.16	.1647	.94	
22	7/8	3/4 Copper Tube (ASTM B88)	34	22	4	4 ... 12	26	
			1.34	.87	.16	.1647	1.02	
			38	22	4	4 ... 12	30	
25	1		1.50	.87	.16	.1647	1.18	
			41	22	4	4 ... 12	33	
28		1 Copper Tube (ASTM B88)	1.61	.87	.16	.1647	1.30	
			43	22	4	4 ... 12	34	
30			1.69	.87	.16	.1647	1.39	
			48	22	4	4 ... 12	40	
35		1-1/4 Copper Tube (ASTM B88)	1.89	.87	.16	.1647	1.57	
			51	22	4	4 ... 12	43	
38	1-1/2		2.01	.87	.16	.1647	1.70	
			55	22	4	4 ... 12	47	
42		1-1/4 Pipe 1-1/2 Copper Tube (ASTM B88)	2.17	.87	.16	.1647	1.85	

Ordering Codes

Pipe / Tube Bushing

***SRF-*20-*PP**

- * Pipe / Tube Bushing SRF
- * Exact outside diameter Ø D1 (mm) 20
- * Material code (see below) PP

Standard Materials



Polypropylene
Colour: Natural colour
Material code: **PP**



Thermoplastic Elastomer (87 Shore-A)
Colour: Black
Material code: **SA**

See pages 154 / 155 for material properties and technical information.

Product Features

- Designed to centre the pipe or tube in a through-hole (e.g. for return lines entering the hydraulic reservoir)
- Vibration and noise absorbing element
- Available for all commonly used Metric and imperial pipe and tube diameters from 6 ... 42 mm and 1/4 ... 1-1/2 in
- Easy plug-in installation





Standard Clamp Body Materials	154
Standard Elastomer Insert Materials	155
Special Clamp Body Materials	156
Standard Clamp Body Designs	158
Materials and Surface Finishings of Metal Parts	159
Property Classes / Grades of Bolts and Screws	159
Thread Conversion Chart	159
General Installation Instructions	160
Tightening Torques / Maximum Loads in Pipe Direction	161
Dimensions and Weights of Clamp Assemblies	162
Packaging Units (Selection)	163



Standard Clamp Body Materials



Material Code	PP	PA	AL	SA
Basic Material	Copolymeric Polypropylene	Polyamide	Aluminium AISi12	Thermoplastic Elastomer
Standard Colour	Green	Black	Natural	Black

Mechanical Properties				
Tensile E-Module	1073 N/mm ² (ISO 527)	> 1400 N/mm ² (ISO 527)	> 65000 N/mm ²	113 N/mm ² at +23 °C / +73.4 °F (ASTM D412)
Notch Impact Strength	8 kJ/m ² at +23 °C / +73.4 °F (acc. to Charpy / ISO 179 / 1eU)	> 15 kJ/m ² at 23 °C / +73.4 °F (acc. to Charpy / ISO 179 / 1eU)		
Low Temperature Notch Impact Strength	3 kJ/m ² at -20 °C / -4.0 °F (acc. to Charpy / ISO 179 / 1eU)	> 3 kJ/m ² at -30 °C / -22.0 °F (acc. to Charpy / ISO 179 / 1eU)		
Tensile Strength at Yield (Tensile Strength)	26 MPa (ISO 527-2)	> 55 MPa (ISO 527)	> 240 MPa (ISO EN 10002)	15,9 MPa (ASTM D412)
Ball Indentation Hardness (Brinell Hardness)	45,4 MPa (ISO 2039-1)	> 65 MPa (ISO 2039-1)	> 70 HBS	
Shore Hardness				87 A (ISO 868) <small>Alternative hardnesses are available upon request! Contact STAUFF for details.</small>

Thermal Properties				
Temperature Resistance (Min ... Max)	-30 °C ... +90 °C / -22 °F ... +194 °F	-40 °C ... +120 °C / -40 °F ... +248 °F (Brief exposure up to +140 °C / +284 °F)	up to +300 °C / up to +572 °F	-40 °C ... +125 °C / -40 °F ... +257 °F

Chemical Properties				
Weak Acids	conditionally consistent	conditionally consistent	conditionally consistent	consistent
Solvents	conditionally consistent	conditionally consistent	conditionally consistent	conditionally consistent
Benzine	conditionally consistent	consistent	consistent	conditionally consistent
Mineral Oils	conditionally consistent	consistent	consistent	conditionally consistent
Other Oils	consistent	consistent	consistent	consistent
Alcohols	consistent	consistent	consistent	consistent
Seawater	consistent	consistent	consistent	consistent



Special Clamp Body Materials

Please contact STAUFF for further details on fire-proof clamp body materials, tested and approved according to several international fire-protection standards (such as BS 6853, EN 45545-2, UL 94 and many more).

See pages 156 / 157 for material properties and technical information.

The information for the Polyamide material PA have been determined in a conditioned state according to ISO 1110.

For Aluminium, the tensile strength (under reversed bending stress) and impact bending strength both rise constantly at decreasing temperatures whilst the value for breaking elongation decreases.

STAUFF preserves the right to supply products made from alternative, but comparable materials with matching technical characteristics.



Standard Clamp Insert Materials

 STAUFF Group 4 and 6 (Standard Series)
 STAUFF Group 4S to 6S (Heavy Series)

STAUFF Group 7S to 10S (Heavy Series)

SA	EPDM	Material Code
Thermoplastic Elastomer	Ethylene Propylene Diene Monomer	Basic Material
Black	Black	Standard Colour

		Mechanical Properties
16 N/mm ² at +23 °C / +73.4 °F (ASTM D412)		Tensile E-Module
		Notch Impact Strength
		Low Temperature Notch Impact Strength
8,3 MPa (ASTM D412)	9,0 MPa (DIN 53504)	Tensile Strength at Yield (Tensile Strength)
		Ball Indentation Hardness (Brinell Hardness)
73 A (ISO 868)	70 A (DIN 53505)	Shore Hardness

		Thermal Properties
-40 °C ... +125 °C / -40 °F ... +257 °F	-50 °C ... +120 °C / -58 °F ... +248 °F	Temperature Resistance (Min ... Max)

		Chemical Properties
consistent	consistent	Weak Acids
conditionally consistent	consistent	Solvents
conditionally consistent	conditionally consistent	Benzine
conditionally consistent	conditionally consistent	Mineral Oils
consistent	conditionally consistent	Other Oils
consistent	consistent	Alcohols
consistent	consistent	Seawater



Special Clamp Insert Materials

Please contact STAUFF for further details on fire-proof clamp body materials, tested and approved according to several international fire-protection standards (such as BS 6853, EN 45545-2, UL 94 and many more).

See pages 156 / 157 for material properties and technical information.



Special Clamp Body Materials (Selection)

Preventive Fire Protection



Material Code	PA-VO	PP-DA	PA-GF30-USR
Basic Material	Polyamide	Polypropylene	Polyamide
Standard Colour	Grey / Black	Weiss	Black

Mechanical Properties			
Tensile E-Module	1500 MPa (ISO 527-2)	1614 N/mm ² (ISO 527) bei +23 °C / +73.4 °F: 50 mm/min	8274 MPa (ASTM D638)
Notch Impact Strength	35 kJ/m ² at +23 °C / +73.4 °F (acc. to Charpy / ISO 179 / 1eU)	13 kJ/m ² at +23 °C / +73.4 °F (acc. to IZOD / ISO 179 / 1eA)	15 kJ/m ² (ASTM D256)
Low Temperature Notch Impact Strength		1,5 kJ/m ² at -25 °C / -13.0 °F (acc. to IZOD / ISO 179 / 1eA)	
Tensile Strength at Yield (Tensile Strength)	45 MPa (ISO 527-2)	12,4 MPa (ISO 527) at +23 °C / +73.4 °F: 50 mm/min	131 MPa (ASTM D638)
Ball Indentation Hardness (Brinell Hardness)	100 N/mm ² (ISO 2039-1)		
Shore Hardness			

Thermal Properties			
Temperature Resistance (Min ... Max)	-30 °C ... +120 °C / -22 °F ... +248 °F	-25 °C ... +90 °C / -13 °F ... +194 °F	-30 °C ... +120 °C / -22 °F ... +248 °F

Features			
Approvals / Properties	<p>Tested and approved acc. to UL94 ¹ (material thickness: 3 mm)</p> <ul style="list-style-type: none"> Classification: V-0 (Vertical Burning Test) <p>Tested and approved acc. to EN 45545-2 (material thickness: 3,5 mm)</p> <ul style="list-style-type: none"> Requirements set R22 / R23 / R24 / R26 Hazard level HL1 - HL3 <p>Tested and approved acc. to DIN 5510, Part 2 (material thickness: 3 mm)</p> <ul style="list-style-type: none"> Combustibility classification: S4 Smoke development classification: SR2 Dripping classification: ST2 <p>Tested and approved acc. to NF F 16-101 (material thickness: 3 mm)</p> <ul style="list-style-type: none"> Classification: I3 / F2 <p>Low Smoke Zero Halogen (LSZH)</p>	<p>Tested and approved acc. to UL94 ¹ (material thickness: 3 mm)</p> <ul style="list-style-type: none"> Classification: V-0 (Vertical Burning Test) <p>Tested and approved acc. to Def Stan 07-247</p> <ul style="list-style-type: none"> Assessment: category B <p>Approved by the UK Ministry of Defence (MoD)</p> <p>Low Smoke Zero Halogen (LSZH)</p>	<p>Tested and approved acc. to ASTM D638 (material thickness: 1,5 mm)</p> <ul style="list-style-type: none"> Classification: V-0 (Vertical Burning Test) <p>Tested and approved acc. to NFPA 130 (material thickness: 3 mm)</p> <ul style="list-style-type: none"> no burning dripping <p>Halogen Free Flame Retardant (HFFR)</p>

¹ Successful testing and approval according to UL94 (classification V-0) is equivalent to EN 45545-2 (requirements set R26; hazard level HL3). The information for PA-VO has been determined in a conditioned state according to ISO 1110.

STAUFF preserves the right to supply products made from alternative, but comparable materials with matching technical characteristics.



Special Clamp Body Materials (Selection)

Preventive Fire Protection



PP6853	PP-V0	SA-V0	Material Code
Polypropylene	Polypropylene	Thermoplastic Elastomer	Basic Material
White	Black	Natural	Standard Colour

			Mechanical Properties
1264 MPa (ICE 60811-1-1)		113 N/mm ² at +23 °C / +73.4 °F (ASTM D412)	Tensile E-Module
17 kJ/m ² at +23 °C / +73.4 °F (acc. to IZOD / ISO 179 / 1eA)	5 kJ/m ² at +23 °C / +73.4 °F (acc. to ISO 180/A)		Notch Impact Strength
			Low Temperature Notch Impact Strength
25 MPa (ICE 60811-1-1)	24 MPa (ISO 527)	15,9 MPa (ASTM D412)	Tensile Strength at Yield (Tensile Strength)
			Ball Indentation Hardness (Brinell Hardness)
		86 A (ISO 868)	Shore Hardness

			Thermal Properties
-25 °C ... +90 °C / -13 °F ... +194 °F	-25 °C ... +90 °C / -13 °F ... +194 °F	-55 °C ... +90 °C / -67 °F ... +194 °F	Temperature Resistance (Min ... Max)

			Features
<p>Tested and approved acc. to EN 45545-2 (material thickness: 3 mm)</p> <ul style="list-style-type: none"> Requirements set R22 / R23 / R24 / R26 Hazard level HL1 - HL3 <p>Tested and approved acc. to BS 6853 (Code of practice for fire precautions in the design / construction of passenger carrying trains)</p> <ul style="list-style-type: none"> Assessment: category 1a <p>Compliant to the requirements of London Underground / Metronet (standard 2-01001-002: Fire Safety Performance of Materials)</p> <p>Tested and approved acc. to DIN 5510, Part 2 (material thickness: 25 mm)</p> <ul style="list-style-type: none"> Combustibility classification: S4 Smoke development classification: SR2 Dripping classification: ST2 <p>Tested and approved acc. to Def Stan 07-247</p> <ul style="list-style-type: none"> Assessment: category B <p>Compliant to the requirements of JRMA (Japan Railway Rollingstock & Machinery Association)</p> <ul style="list-style-type: none"> Classification: extremely incombustible <p>Low Smoke Zero Halogen (LSZH)</p>	<p>Tested and approved acc. to UL94¹ (material thickness: 3 mm)</p> <ul style="list-style-type: none"> Classification: V-0 (Vertical Burning Test) 	<p>Tested and approved acc. to UL94¹ (material thickness: 3 mm)</p> <ul style="list-style-type: none"> Classification: V-0 (Vertical Burning Test) 	Approvals / Properties

¹ Successful testing and approval according to UL94 (classification V-0) is equivalent to EN 45545-2 (requirements set R26; hazard level HL3).



Standard Clamp Body Designs



Profiled Design

Profiled Inside Surface with Tension Clearance

- Available in the Standard, Heavy, Twin and Heavy Twin Series
- Recommended for the safe installation of rigid pipes or tubes
- Available for all commonly used outside diameters and nominal sizes
- Vibration/noise reducing and impact absorbing effect towards the direction of the line provided by the grooves on the inside of the clamp bodies
- Clearance S between the clamp halves provides tension of the tube or pipe
- To be used as fixed point clamp preventing the line from sliding (see page 161 for Maximum Loads in Pipe Direction)

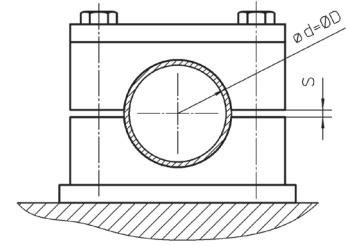

Type H (Smooth)

Smooth Inside Surface w/o Tension Clearance

- Available in the Standard, Heavy and Twin Series
- Recommended for the safe installation of hoses or cables
- Available for all commonly used outside diameters and nominal sizes
- Smooth inside surface and chamfered edges avoid damaging of the hose or cable

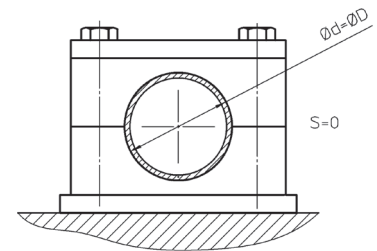

- Choose the diameter ϕD of the clamp body slightly larger (in accordance to your specific requirements) than the outside diameter ϕd of the pipe, tube, hose or cable in order to use it as a longitudinal guide allowing the line to slide

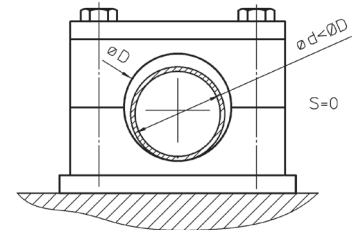

Type RI (with Elastomer Insert)

- Available in the Standard, Heavy and Heavy Twin Series
- Recommended for the extra-gentle installation of pipes, tubes, hoses or cables
- Available for all commonly used outside diameters and nominal sizes
- Elastomer insert made of Thermoplastic Elastomer with a hardness of 73 Shore-A provides most effective reduction of vibration and noise caused by vibration

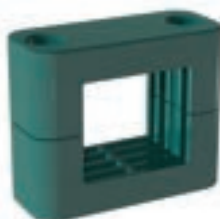

Rectangular Design - Type VK

- Available in the Standard Series (STAUFF Group 5)
- Recommended for the safe installation of proximity switches according to DIN EN 60947-5-2 or similar, rectangular construction, with a square of 40 mm x 40 mm (1.57 in x 1.57 in) or 40 mm x 36 mm (1.57 in x 1.42 in)



Materials and Surface Finishings of Metal Parts

Materials

Unless otherwise stated, all metal parts (e.g. weld plates, cover plates, bolts, rail nuts etc.) are made of **Carbon Steel** (surface finishing according to material code).

Besides that, all metal parts are also available **ex stock** in two different stainless steel qualities:

Stainless Steel V2A

- 1.4301 / 1.4305 (AISI 304 / 303)
- Material code: W4

Stainless Steel V4A

- 1.4401 / 1.4571 (AISI 316 / 316 Ti)
- Material code: W5

Aluminium

- Aluminium EN AW-6060
- Material code: W85

Alternative materials (e.g. Aluminium) are available upon request. Contact STAUFF for further information.

Surface Finishings

Unless otherwise stated, all metal parts made of Carbon Steel are available with the following standard surface finishings:

Carbon Steel, uncoated

- Material code: W1

Carbon Steel, phosphated

- Fe/Znph r 10 according to DIN EN 12476
- Material code: W2

Carbon Steel, zinc/nickel-plated

- More than 1200 hours resistance against red rust / base metal corrosion in the salt spray test to DIN EN ISO 9227
- Free of hexavalent chromium Cr(VI)
- RoHS compliant according to 2002/95/EC (Restrictions of the Use of Hazardous Substances)
- ELV compliant according to 2000/53/EC (End of Life Vehicles Directive)
- Material code: W3

Alternative surface finishings are available upon request. Contact STAUFF for further information.



Original STAUFF Cover Plate with Zinc/Nickel-Coating:
No signs of corrosion after 1200 hours in the salt spray chamber!



Original STAUFF Cover Plates with alternative surface finishings widely-used by competitors in the market (from left to right):

- Galvanisation and blue-chromating after 96 hours
- Galvanisation and yellow-chromating after 192 hours
- Zinc-coating, thick-film passivation and sealing after 192 hours

In all three cases, signs of white and red rust / base metal corrosion are quite clearly visible! Please do not hesitate to contact STAUFF and ask for a detailed report.

Thread Conversion Chart

Metric ISO vs. Unified Coarse (UNC) Thread

Unless otherwise stated, all threaded parts available with Metric ISO thread or unified coarse (UNC) thread.

Standard Series (DIN 3015, Part 1)

Group STAUFF	DIN	Thread Metric ISO	Unified Coarse
1 to 8	0 to 8	M6	1/4–20 UNC

Heavy Series (DIN 3015, Part 2)

Group STAUFF	DIN	Thread Metric ISO	Unified Coarse
3S to 5S	1 to 3	M10	3/8–16 UNC
6S	4	M12	7/16–14 UNC
7S	5	M16	5/8–11 UNC
8S	6	M20	3/4–10 UNC
9S	7	M24	7/8–9 UNC
10S	8	M30	1-1/8–7 UNC
11S to 12S	9 to 10	M30	1-1/4–7 UNC

Twin Series (DIN 3015, Part 3)

Group STAUFF	DIN	Thread Metric ISO	Unified Coarse
1D	1	M6	1/4–20 UNC
2D to 5D	2 to 5	M8	5/16–18 UNC

Property Classes / Grades of Bolts and Screws

Hexagon Head Bolt
Socket Cap Screw
Slotted Head Screw

Bolt / Screw Type	Material Code	Property Class / Grade	
		Metric ISO Threaded Bolts / Screws	Unified Coarse Threaded Bolts / Screws
Hexagon Head Bolt Type AS	W1, W2, W3	8.8 (according to DIN EN ISO 898)	5 (according to SAE J429)
	W4	A2-70 (according to DIN EN ISO 3506)	AISI 304 / B8 (according to ASTM A193)
	W5	A4-70 (according to DIN EN ISO 3506)	AISI 316 / B8M (according to ASTM A193)
Socket Cap Screw Type IS	W1, W2, W3	8.8 (according to DIN EN ISO 898)	5 (according to SAE J429)
	W4	A2-70 (according to DIN EN ISO 3506)	AISI 304 / B8 (according to ASTM A193)
	W5	A4-70 (according to DIN EN ISO 3506)	AISI 316 / B8M (according to ASTM A193)
Slotted Head Screw Type LI	W1, W2, W3	4.8 (according to DIN EN ISO 898)	2 (according to SAE J429)
	W4	A2-70 (according to DIN EN ISO 3506)	AISI 304 / B8 (according to ASTM A193)
	W5	A4-70 (according to DIN EN ISO 3506)	AISI 316 / B8M (according to ASTM A193)

Unless otherwise stated, the above mentioned property classes / grades apply as standards for bolts and screws supplied by STAUFF. The information indicate the minimum requirements; higher property classes are available upon request. Contact STAUFF for details.



Basic Installation Instructions



Installation on Weld Plate

Different types of weld plates are available for all STAUFF Clamps according to DIN 3015 as well as for most of the other series and many custom-designed special clamps.

- Place weld plates in their designated positions. Please make sure these positions are suitable for the expected loads.
- Mark the positions of the weld plates to ensure best alignment.
- Weld the weld plates into position. Elongated weld plates can also be mounted to their positions by using screws or bolts.
- Push bottom clamp half onto weld plate.
- Insert pipe, tube, hose, cable or any other type of line.
- Place second clamp half and cover plate (optional) on top and mount clamp assembly by using screws or bolts.

Unless otherwise stated, the bolt lengths indicated for clamps according to DIN 3015 refer to the installation on weld plates and mounting rails as well as multi-level (stacking) installation. For direct installation, different lengths may be required.



Installation on Mounting Rail

STAUFF Mounting Rails are available in different heights. STAUFF Rail Nuts are available for all STAUFF Clamps according to DIN 3015 (Heavy Series up to STAUFF Group 6S only) as well as for many custom-designed special clamps.

- Place mounting rails in their designated positions. Please make sure these bases are suitable for the expected loads.
- Mark the positions of the mounting rails to ensure best alignment.
- Weld the mounting rails into position. Mounting rails can also be mounted to their positions by using side-mounting brackets with screws or bolts.
- Insert rail nuts into mounting rail and turn until stop to lock (Standard and Twin Series) or slide in rail nut (Heavy Series).
- Push bottom clamp half onto rail nuts.
- Insert pipe, tube, hose, cable or any other type of line.
- Place second clamp half and cover plate (optional) on top and mount clamp assembly by using screws or bolts.

The exact positions of the clamp assemblies can still be adjusted before being firmly bolted.



Multi-Level (Stacking) Installation

Stacking bolts permit the multi-level assembly of clamps of identical group sizes. Safety locking plates inserted between the levels prevent the stacking bolts from turning. The Twin Series also allows stacking of different group sizes (STAUFF Groups 2D to 5D).

- Push bottom clamp half onto weld plate or rail nuts.
- Insert pipe, tube, hose, cable or any other type of line.
- Place second clamp half.
- Insert stacking bolts into the clamp assembly and tighten using the following tightening torques (or in a way that the clamp halves are in contact with the line over the entire internal contact surface):
 - Standard Series** 1 ... 2 N·m / .75 ... 1.5 ft·lb (hand-tightened)
 - Heavy Series** 5 N·m / 3.75 ft·lb
 - Twin Series** 1 ... 2 N·m / .75 ... 1.5 ft·lb (hand-tightened)
- Place safety locking plate on top of clamp assembly.
- Proceed with next levels. Top level to be assembled with cover plate and hexagon head bolts using the tightening torques as indicated on page 161.

STAUFF multi-level clamp assemblies can be mounted both to weld plates or to mounting rails (with rail nuts).

Recommended Distance between Clamps

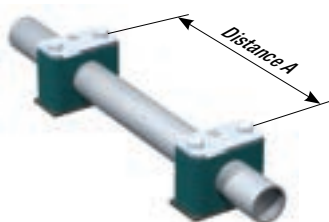

Please note: The recommended distances between clamps stated below are standard values and valid for static loads only.

Outside Diameter (mm)	(in)	Distance A (m)	(ft)
6,0 ... 12,7	.2350	1,00	3,28
12,7 ... 22,0	.5086	1,20	3,94
22,0 ... 32,0	.86 ... 1.25	1,50	4,92
32,0 ... 38,0	1.25 ... 1.50	2,00	6,56
38,0 ... 57,0	1.5 ... 2.25	2,70	8,86
57,0 ... 75,0	2.25 ... 2.95	3,00	9,84
75,0 ... 76,1	2.95 ... 3.00	3,50	11,48
76,1 ... 88,9	3.00 ... 3.50	3,70	12,14
88,9 ... 102,0	3.50 ... 4.00	4,00	13,12
102,0 ... 114,0	4.00 ... 4.50	4,50	14,76

Outside Diameter (mm)	(in)	Distance A (m)	(ft)
114,0 ... 168,0	4.50 ... 6.60	5,00	16,40
168,0 ... 219,0	6.60 ... 8.60	6,00	19,68
219,0 ... 324,0	8.60 ... 12.70	6,70	21,98
324,0 ... 356,0	12.70 ... 14.00	7,00	22,96
356,0 ... 406,0	14.00 ... 16.00	7,50	24,60
406,0 ... 419,0	16.00 ... 16.50	8,20	26,90
419,0 ... 508,0	16.50 ... 20.00	8,50	27,88
508,0 ... 521,0	20.00 ... 20.50	9,00	29,52
521,0 ... 558,0	20.50 ... 22.00	10,00	32,80
558,0 ... 800,0	22.00 ... 31.50	12,50	41,00

Installation next to Pipe Bends, Connectors / Couplings and Valves



Please note the following information on the installation of STAUFF Clamps next to pipe bends, connectors / couplings and valves:

Pipe Bends

Pipe bends should be supported by STAUFF Clamps as close to the bends as possible. Furthermore, it is recommended to design these clamps as fixed point clamps.

Connections / Couplings

The first clamp should be placed directly next to the connector / coupling. This protects the connector / coupling from vibrations.

Valves

If valves are incorporated in the pipelines, it is recommended that support is provided in front of and behind these valves.

Contact STAUFF for further information.



Tightening Torques and Maximum Loads In Pipe Direction

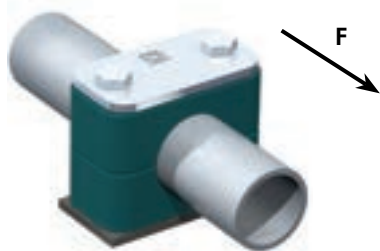

All tightening torques and maximum loads in pipe direction refer to STAUFF Clamp Bodies (profiled inside surface with tension clearance) with Cover Plates, Weld Plates and Hexagon Head Bolts according to DIN EN ISO 4014/4017 (DIN 931/933).

The max. load in pipe direction (according to DIN 3015-10:1999) is an average value, determined by three tests at +23 °C / +73.4 °F with a steel pipe according to DIN EN 10220, St37 – rolled surface – taking static friction into consideration.

Sliding starts when the shown values (F) are reached.

Standard Series (DIN 3015-1:1999)

Group	Hexagon Head Bolt DIN EN ISO 4014/4017 (DIN 931/933)		Polypropylene (PP)				Polyamide (PA)				Aluminium (AL)				
	STAUFF	DIN	Metric ISO Thread	Unified Coarse (UNC) Thread	Tightening Torque (N-m) (ft-lb)		Maximum Load in Pipe Direction F (kN) (lbf)		Tightening Torque (N-m) (ft-lb)		Maximum Load in Pipe Direction F (kN) (lbf)		Tightening Torque (N-m) (ft-lb)		Maximum Load in Pipe Direction F (kN) (lbf)
1	0	M6	1/4-20 UNC	8	6	0,6	135	10	7	0,6	135	12	9	3,5	787
1A	1	M6	1/4-20 UNC	8	6	1,1	247	10	7	0,7	157	12	9	4,2	944
2	2	M6	1/4-20 UNC	8	6	1,3	292	10	7	0,8	180	12	9	4,3	967
3	3	M6	1/4-20 UNC	8	6	1,4	315	10	7	1,6	360	12	9	4,9	1101
4	4	M6	1/4-20 UNC	8	6	1,5	337	10	7	1,7	382	12	9	5,0	1124
5	5	M6	1/4-20 UNC	8	6	1,9	427	10	7	2,0	450	12	9	7,3	1641
6	6	M6	1/4-20 UNC	8	6	2,0	450	10	7	2,5	562	12	9	8,9	2000
7	7	M6	1/4-20 UNC	8	6	2,3	517	10	7	3,2	719				
8	8	M6	1/4-20 UNC	8	6	2,6	585	10	7	3,5	787				

Heavy Series (DIN 3015-2:1999)

Group	Hexagon Head Bolt DIN EN ISO 4014/4017 (DIN 931/933)		Polypropylene (PP)				Polyamide (PA)				Aluminium (AL)				
	STAUFF	DIN	Metric ISO Thread	Unified Coarse (UNC) Thread	Tightening Torque (N-m) (ft-lb)		Maximum Load in Pipe Direction F (kN) (lbf)		Tightening Torque (N-m) (ft-lb)		Maximum Load in Pipe Direction F (kN) (lbf)		Tightening Torque (N-m) (ft-lb)		Maximum Load in Pipe Direction F (kN) (lbf)
3S	1	M10	3/8-16 UNC	12	9	1,6	360	20	15	4,2	944	30	22	12,1	2720
4S	2	M10	3/8-16 UNC	12	9	2,9	652	20	15	4,5	1044	30	22	15,1	3395
5S	3	M10	3/8-16 UNC	15	11	3,3	742	25	18	5,1	1146	35	26	15,5	3485
6S	4	M12	7/16-14 UNC	30	22	8,2	1843	40	30	9,3	2090	55	41	29,5	6609
7S	5	M16	5/8-11 UNC	45	33	11,0	2472	55	41	15,8	3551	120	86	34,9	7845
8S	6	M20	3/4-10 UNC	80	59	14,0	3147	150	111	21,0	4720	220	162	50,0	11240
9S	7	M24	7/8-9 UNC	110	81	28,0	6300	200	148	32,0	7193	250	184	70,6	15871
10S	8	M30	1-1/8-7 UNC	180	133	40,0	8992	350	258	48,0	10790	500	369	84,5	18996
11S	9	M30	1-1/4-7 UNC	200	148	119,0	26752	370	273	125,0	27650	500	369	181,5	40802
12S	10	M30	1-1/4-7 UNC	270	199	168,0	37767	450	332	180,0	40465	600	443	244,5	54965

Twin Series (DIN 3015-2:1999)

Group	Hexagon Head Bolt DIN EN ISO 4014/4017 (DIN 931/933)		Polypropylene (PP)				Polyamide (PA)				
	STAUFF	DIN	Metric ISO Thread	Unified Coarse (UNC) Thread	Tightening Torque (N-m) (ft-lb)		Maximum Load in Pipe Direction F (kN) (lbf)		Tightening Torque (N-m) (ft-lb)		Maximum Load in Pipe Direction F (kN) (lbf)
1D	1	M6	1/4-20 UNC	5	4	0,9	202	5	4	0,9	202
2D	2	M8	5/16-18 UNC	12	9	2,1	472	12	9	2,2	495
3D	3	M8	5/16-18 UNC	12	9	1,9	427	12	9	2,0	450
4D	4	M8	5/16-18 UNC	12	9	2,7	607	12	9	2,9	652
5D	5	M8	5/16-18 UNC	8	6	1,7	382	8	6	2,5	562

Only for the standard clamp body materials which are listed on page 154. In case of doubt, please contact STAUFF in advance.



Dimensions and Weights of Clamp Assemblies

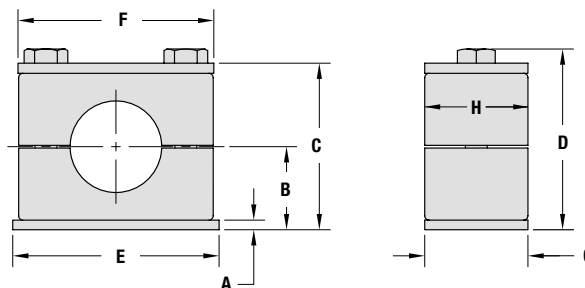

Standard Series (DIN 3015, Part 1)

Group	STAUFF	DIN	Dimensions (mm/m)								Weight per 100 Pcs.			
			A	B		C		D		E	F	G	H	SP-**-PP-DP-AS (kg/lbs)
				Profilled Design	Type H (Smooth)	Profilled Design	Type H (Smooth)	Profilled Design	Type H (Smooth)					
1	0	3	16,5	16	33	32	37	36	31,5	28	30	30	6,20	
		.12	.65	.63	1.30	1.26	1.46	1.42	1.24	1.10	1.18	1.18	13,64	
1A	1	3	16,5	16	33	32	37	36	36	34	30	30	8,10	
		.12	.65	.63	1.30	1.26	1.46	1.42	1.41	1.33	1.18	1.18	17,82	
2	2	3	19,5	19	39	38	43	42	42	40,5	30	30	9,40	
		.12	.77	0.75	1.54	1.50	1.69	1.65	1.65	1.59	1.18	1.18	20,68	
3	3	3	21	20,75	42	41,5	46	45,5	50	48	30	30	11,20	
		.12	.83	.82	1.65	1.64	1.81	1.80	1.96	1.88	1.18	1.18	24,64	
4	4	3	24	23,75	48	47,5	52	51,5	60	57	30	30	13,70	
		.12	.94	.94	1.89	1.87	2.05	2.03	2.36	2.24	1.18	1.18	30,14	
5	5	3	32	31,25	64	62,5	68	66,5	71	70	30	30	17,10	
		.12	1.26	1.23	2.52	2.46	2.68	2.62	2.79	2.75	1.18	1.18	37,62	
6	6	3	36	35,25	72	70,5	76	74,5	88	86	30	30	21,30	
		.12	1.42	1.39	2.83	2.78	2.99	2.94	3.46	3.38	1.18	1.18	46,86	
7	7	5	51,5	51	103	102	107	106	122	118	30	30	42,10	
		.20	2.03	2.01	4.06	4.02	4.21	4.17	4.81	4.65	1.18	1.18	92,62	
8	8	5	64	63	128	126	132	130	148	144	30	30	44,00	
		.20	2.52	2.48	5.04	4.96	5.20	5.12	5.83	5.67	1.18	1.18	96,80	

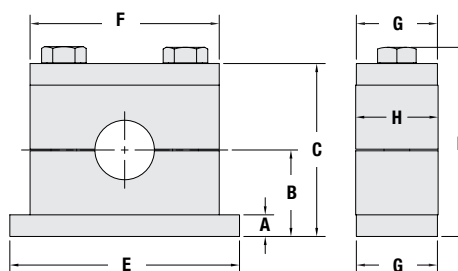

Heavy Series (DIN 3015, Part 2)

Group	STAUFF	DIN	Dimensions (mm/m)								Weight per 1 Pc.			
			A	B		C		D		F	AL	G	H	SPAL-**-PP-DPAL-AS (kg/lbs)
				Profilled Design	TypeH(Smooth)	Profilled Design	TypeH(Smooth)	Profilled Design	TypeH(Smooth)					
3S	1	8	24	23,25	48	46,5	54,4	52,9	74	55	56	30	30,5	0,32
		.31	.94	.92	1.89	1.83	2.14	2.09	2.91	2.16	2.20	1.18	1.20	.70
4S	2	8	32	31,25	64	62,5	70,4	68,9	86	70	70	30	30,5	0,40
		.31	1.26	1.23	2.52	2.46	2.77	2.72	3.39	2.76	2.76	1.18	1.20	.88
5S	3	8	38	37	76	74	82,4	80,4	100	85	85	30	30,5	0,49
		.31	1.50	1.46	2.99	2.91	3.24	3.17	3.94	3.35	3.35	1.18	1.20	1,08
6S	4	10	54,5	53,5	109	107	116,5	114,5	140	115	120	45	45	1,21
		.39	2.15	2.11	4.29	4.21	4.59	4.51	5.51	4.53	4.72	1.77	1.77	2,66
7S	5	10	70		140		150		180	154	152	60	60	2,30
		.39	2.76		5.51		5.91		7.09	6.06	5.98	2.36	2.36	5,06
8S	6	15	99		198		210,5		226	206	208	80	80	5,56
		.59	3.90		7.80		8.29		8.90	8.11	8.19	3.15	3.15	12,26
9S	7	15	115		230		245		270	251	255	90	91	7,97
		.59	4.53		9.06		9.65		10.63	9.88	10.04	3.54	3.58	17,58
10S	8	25	160		320		338,7		340	336	326	120	120	22,16
		.98	6.30		12.60		13.33		13.39	13.22	12.83	4.72	4.72	48,75
11S	9	30	235		470		488,7		520	470	470	160	162	54,11
		1.18	9.25		18.50		19.24		20.47	18.50	18.50	6.30	6.38	119,04
12S	10	30	295		590		608,7		680	630	630	180	182	77,40
		1.18	11.61		23.23		23.96		26.77	24.80	24.80	7.09	7.16	170,28



Dimensions & Weights of Clamp Assemblies

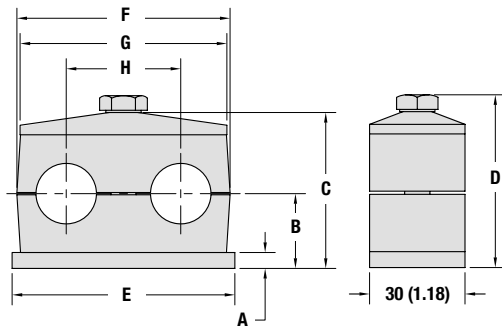

Twin Series (DIN 3015, Part 3)

Group	STAUFF	DIN	Dimensions (mm/in)								Weight per 100 Pcs. SP-**-**-PP-GD-AS (kg/lbs)			
			A	B		C		D		E		F	G	H
				Profiled Design	Type H (Smooth)	Profiled Design	Type H (Smooth)	Profiled Design	Type H (Smooth)					
1D	1		3	16,5	16,25	37	36,5	41	40,5	37	36	34	20	7,60
			.12	.65	.64	1.46	1.44	1.61	1.59	1.46	1.42	1.34	.79	16.72
2D	2		5	18,5	18,25	39	38,5	44	43,5	55	53	52	29	13,50
			.20	.73	.72	1.54	1.52	1.73	1.71	2.17	2.09	2.05	1.14	29.70
3D	3		5	23,5	23,25	49	48,5	54	53,5	70	67	65	36	17,70
			.20	.93	.92	1.93	1.91	2.13	2.11	2.76	2.64	2.56	1.42	38.94
4D	4		5	25	24	52	50	57	55	85	80	79	45	20,40
			.20	.98	.94	2.05	1.97	2.24	2.17	3.35	3.15	3.11	1.77	44.88
5D	5		5	31,5	31	65	64	70	69	110	106	102	56	27,70
			.20	1.24	1.22	2.56	2.52	2.76	2.72	4.33	4.17	4.02	2.20	60.94

Packaging Units (Selection)

Standard Series (DIN 3015, Part 1)

Clamp Bodies (Polypropylene / Polyamide)

Group	STAUFF	DIN	Quantity per Bag (in Pcs.)
1 - 6	0 - 6		25
7 + 8	7 + 8		10

Clamp Bodies (Aluminium)

Group	STAUFF	DIN	Quantity per Bag (in Pcs.)
1 - 5	0 - 5		25
6	6		10

Weld Plates (Type SP)

Cover Plates (Type DP)

Group	STAUFF	DIN	Quantity per Bag (in Pcs.)
1 - 6	0 - 6		25
7 + 8	7 + 8		10

Hexagon Rail Nut (Type SM)

Channel Rail Adaptor (Type CRA)

Group	STAUFF	DIN	Quantity per Bag (in Pcs.)
1 - 8	0 - 8		50

Heavy Series (DIN 3015, Part 2)

Clamp Bodies (Polypropylene / Polyamide)

Group	STAUFF	DIN	Quantity per Bag (in Pcs.)
3S - 6S	1 - 4		20
7S	5		10
8S - 12S	6 - 10		1

Clamp Bodies (Aluminium)

Group	STAUFF	DIN	Quantity per Bag (in Pcs.)
3S - 6S	1 - 4		20
7S	5		10
8S - 12S	6 - 10		1

Weld Plates (Type SPAL)

Cover Plates (Type DPAL)

Group	STAUFF	DIN	Quantity per Bag (in Pcs.)
3S - 6S	1 - 4		20
7S	5		10
8S - 12S	6 - 10		1

Mounting Rail Nut (Type GMV)

Channel Rail Adaptor (Type CRA)

Group	STAUFF	DIN	Quantity per Bag (in Pcs.)
3S - 6S	1 - 4		40

Twin Series (DIN 3015, Part 3)

Clamp Bodies (Polypropylene / Polyamide)

Group	STAUFF	DIN	Quantity per Bag (in Pcs.)
1D - 4D	1 - 4		25
5D	5		10

Weld Plates (Type SP)

Cover Plates (Type GD)

Group	STAUFF	DIN	Quantity per Bag (in Pcs.)
1D - 4D	1 - 4		25
5D	5		10

Hexagon Rail Nut (Type SM)

Channel Rail Adaptor (Type CRA)

Group	STAUFF	DIN	Quantity per Bag (in Pcs.)
1D	1		50
2D - 5D	2 - 5		25

Contact STAUFF and ask for standard packaging units for further components or special packaging options.



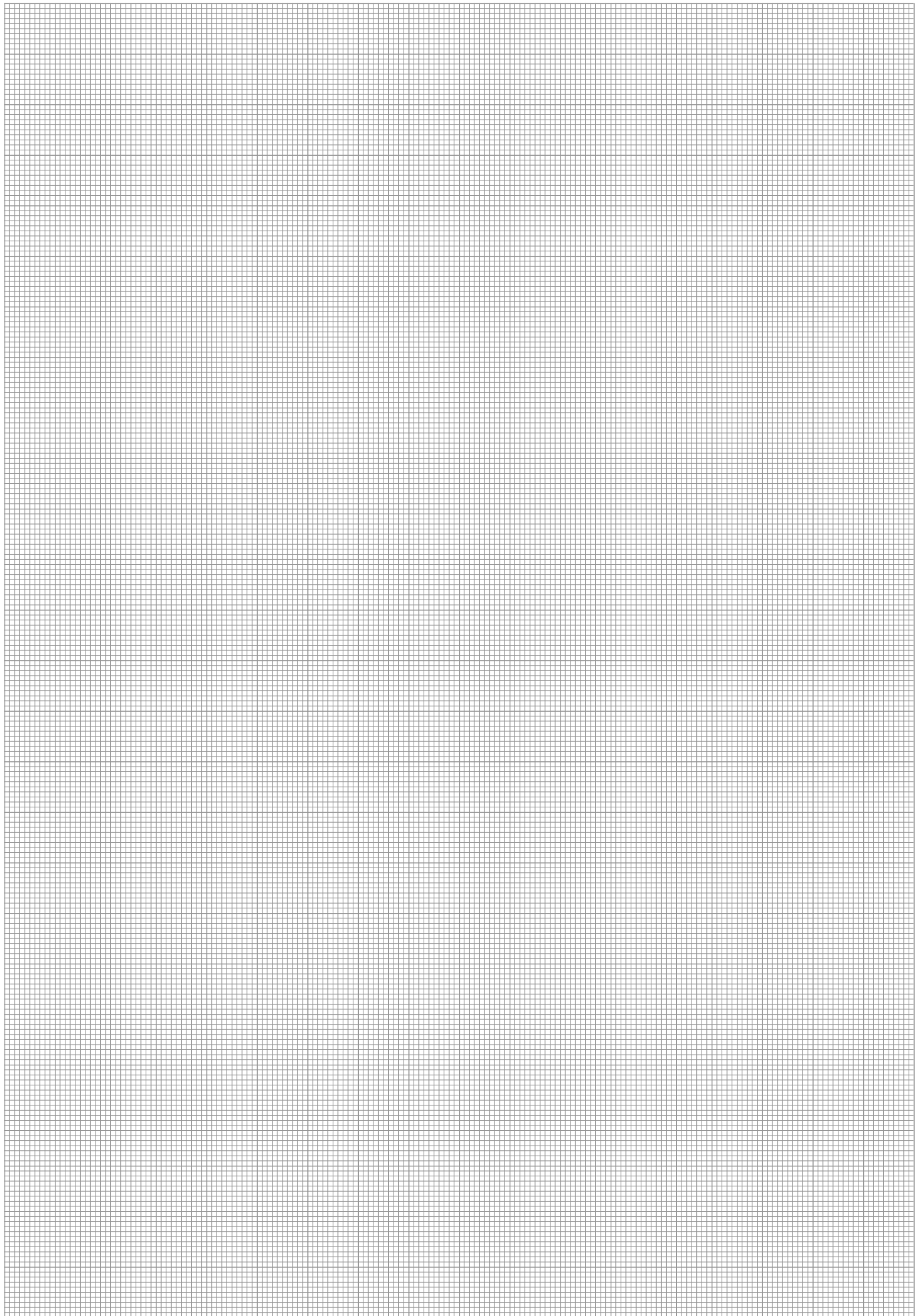

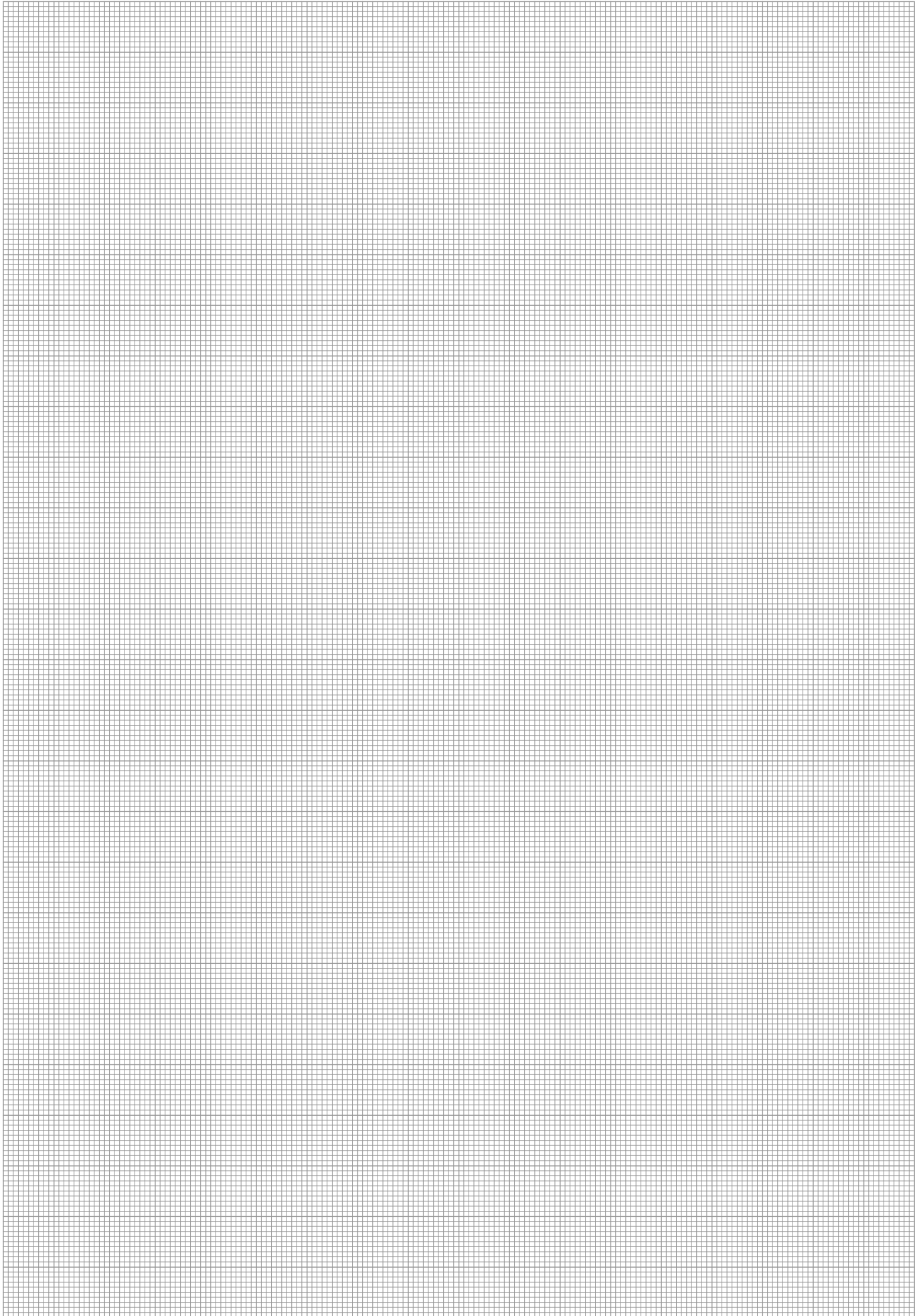



Product-Specific Abbreviations	168
---------------------------------------	------------

Global Contact Directory	170
---------------------------------	------------



Product-Specific Abbreviations

Abbreviation	Product Category	Product Description	Page
ACT	STAUFF ACT Clamps: Anti-Corrosion Technology	Clamp Body - Standard Series	74
ACT	STAUFF ACT Clamps: Anti-Corrosion Technology	Clamp Body - Twin Series	82
AF	Standard Series according to DIN 3015, Part 1	Stacking Bolt	29
AF	Heavy Series according to DIN 3015, Part 2	Stacking Bolt	47
AF	Twin Series according to DIN 3015, Part 3	Stacking Bolt	61
AF	Heavy Twin Series	Stacking Bolt	68
AG	Other Types of Clamps	Agriculture Twin Series	150
AL	Technical Appendix	Standard Clamp Body Material	154
AS	Standard Series according to DIN 3015, Part 1	Hexagon Head Bolt	26
AS	Heavy Series according to DIN 3015, Part 2	Hexagon Head Bolt	45
AS	Twin Series according to DIN 3015, Part 3	Hexagon Head Bolt	59
AS	Heavy Twin Series	Hexagon Head Bolt	68
AS	Light Series	Hexagon Head Bolt	115
BSP	Standard Series according to DIN 3015, Part 1	Bridge Weld Plate	22
CC	Standard Series according to DIN 3015, Part 1	Clamp Body - Compact Design	19
CHC	Standard Series according to DIN 3015, Part 1	Clamp Body for Conduit Hoses	18
CRA	Standard Series according to DIN 3015, Part 1	Channel Rail Adaptor	25
CRA	Heavy Series according to DIN 3015, Part 2	Channel Rail Adaptor	43
CRA	Twin Series according to DIN 3015, Part 3	Channel Rail Adaptor	58
CRA	Heavy Twin Series	Channel Rail Adaptor	68
DIN1592	Metal DIN Clamps	Heavy Saddle with Tension Clearance - Single-Bolt Design	138
DIN1593	Metal DIN Clamps	Heavy Saddle with Tension Clearance - Two-Bolt Design	139
DIN1596	Metal DIN Clamps	Light Saddle with Tension Clearance - Single-Bolt Design	140
DIN1597	Metal DIN Clamps	Light Saddle with Tension Clearance - Two-Bolt Design	141
DIN3567-A	Metal DIN Clamps	Metal Pipe Clamp with Tension Clearance	136
DIN3567-B	Metal DIN Clamps	Metal Pipe Clamp with Tension Clearance (Extended to One Side)	137
DIT-SR6-SWG	STAUFF SWG: Stud Welding System	Distance Tube	95
DKS	Construction Series	Construction Series Clamp	144
DKSV	Construction Series	Construction Series Clamp (for Anchor Bolt Fastening)	145
DP	Standard Series according to DIN 3015, Part 1	Cover Plate	26
DPAL	Heavy Series according to DIN 3015, Part 2	Cover Plate for Single Clamps	44
DPAS	Heavy Series according to DIN 3015, Part 2	Cover Plate for Double Clamps	44
DPAS	Heavy Twin Series	Cover Plate	67
DPL	Light Series	Cover Plate	119
DS	Other Types of Clamps	Compact Twin Series	150
DSP	Standard Series according to DIN 3015, Part 1	Twin Weld Plate	21
EP	Standard Series according to DIN 3015, Part 1	Insert	28
EPDM	Technical Appendix	Standard Clamp Insert Materials	155
ES	Standard Series according to DIN 3015, Part 1	Insert	28
FB	Flat Steel and Round Steel U-Bolt Clamps	Flat Steel U-Bolt	126
GD	Twin Series according to DIN 3015, Part 3	Cover Plate	58
GMV	Heavy Series according to DIN 3015, Part 2	Mounting Rail Nut	42
GMV	Heavy Twin Series	Mounting Rail Nut	68
IS	Standard Series according to DIN 3015, Part 1	Socket Cap Screw	28
IS	Heavy Series according to DIN 3015, Part 2	Socket Cap Screw	45
IS	Twin Series according to DIN 3015, Part 3	Socket Cap Screw	59
KS	Construction Series	Construction Series Clamp	144
KSV	Construction Series	Construction Series Clamp (for Anchor Bolt Fastening)	145
LBBU	Light Series	Clamp Body - Single Design	112
LBBU	Light Series	Clamp Body - Twin Design	113
LBBU-DP	Light Series	Cover Plate	115
LBBU-HUE	Light Series	Sleeve	114
LBBU-SP	Light Series	Weld Plate	114
LB	Light Series	Clamp Body - Single Design	116
LBG	Light Series	Clamp Body - Twin Design	117
LBU	Light Series	Clamp Body - Twin Design	117
LI	Standard Series according to DIN 3015, Part 1	Slotted Head Screw	28
LN	Light Series	Clamp Body - Single Design	118
LNGF	Light Series	Clamp Body - Twin Design	119
LNUF	Light Series	Clamp Body - Twin Design	119
NRC	Standard Series according to DIN 3015, Part 1	Noise Reduction Clamp	17



Product-Specific Abbreviations

Abbreviation	Product Category	Product Description	Page
PA	Technical Appendix	Standard Clamp Body Material	154
PA-V0	Technical Appendix	Special Clamp Body Material	156
PP	Technical Appendix	Standard Clamp Body Material	154
PP6853	Technical Appendix	Special Clamp Body Material	156
PP-DA	Technical Appendix	Special Clamp Body Material	156
PP-V0	Technical Appendix	Special Clamp Body Material	156
RAP	Standard Series according to DIN 3015, Part 1	Group Weld Plate	21
RAP	Twin Series according to DIN 3015, Part 3	Group Weld Plate	55
RAP-MGR	Standard Series according to DIN 3015, Part 1	Multi-Group Weld Plate	23
RB	Flat Steel and Round Steel U-Bolt Clamps	Round Steel U-Bolt	128
RBD	Flat Steel and Round Steel U-Bolt Clamps	Round Steel U-Bolt (DIN 3570, Type A)	132
RF	Other Types of Clamps	Pipe / Tube Bushing	151
RI	Standard Series according to DIN 3015, Part 1	Elastomer Insert	16
RI	Heavy Series according to DIN 3015, Part 2	Elastomer Insert	39
RI	Heavy Twin Series	Clamp Body with Elastomer Inserts	66
RUK	Flat Steel and Round Steel U-Bolt Clamps	Plastic Pipe Saddle (Short) for Flat Steel U-Bolts	126
RUK	Flat Steel and Round Steel U-Bolt Clamps	Plastic Pipe Saddle (Short) for Round Steel U-Bolts	128
RUL	Flat Steel and Round Steel U-Bolt Clamps	Plastic Pipe Saddle (Long) for Round Steel U-Bolts	130
SA	Technical Appendix	Standard Clamp Body Material	154
SA	Technical Appendix	Standard Clamp Insert Materials	155
SA-V0	Technical Appendix	Special Clamp Body Material	156
SCS	Other Types of Clamps	Channel Rail	149
SI	Standard Series according to DIN 3015, Part 1	Safety Washer	27
SI	Heavy Series according to DIN 3015, Part 2	Safety Washer	46
SI	Twin Series according to DIN 3015, Part 3	Safety Locking Plate	60
SI	Heavy Twin Series	Socket Cap Screw	68
SIG	Standard Series according to DIN 3015, Part 1	Safety Locking Plate	29
SIP	Heavy Series according to DIN 3015, Part 2	Safety Locking Plate	47
SIP	Heavy Twin Series	Safety Locking Plate	68
SIV	Twin Series according to DIN 3015, Part 3	Safety Locking Plate	60
SM	Standard Series according to DIN 3015, Part 1	Hexagon Rail Nut	24
SM	Twin Series according to DIN 3015, Part 3	Hexagon Rail Nut	56
SM	Standard Series according to DIN 3015, Part 1	Hexagon Rail Nut	24
SM	Twin Series according to DIN 3015, Part 3	Hexagon Rail Nut	56
SP	Standard Series according to DIN 3015, Part 1	Weld Plate	20
SP	Twin Series according to DIN 3015, Part 3	Single Weld Plate	55
SPAD	Heavy Twin Series	Weld Plate	67
SPAL	Heavy Series according to DIN 3015, Part 2	Weld Plate for Single Clamps	40
SPAL-DUEB	Heavy Series according to DIN 3015, Part 2	Elongated Weld Plate for Single Clamps	41
SPAS-DUEB	Heavy Series according to DIN 3015, Part 2	Weld Plate for Double Clamps	40
SPAS-DUEB	Heavy Series according to DIN 3015, Part 2	Elongated Weld Plate for Double Clamps	41
SPC	Other Types of Clamps	Cushion Clamp	148
SPV	Standard Series according to DIN 3015, Part 1	Elongated Weld Plate	20
STC	Other Types of Clamps	Cushion Clamp	148
STSV	Heavy Series according to DIN 3015, Part 2	Mounting Rail	42
STSV	Heavy Twin Series	Mounting Rail	68
SWG-AGS	STAUFF SWG: Stud Welding System	Distance Adaptor	95
SWG-CTH-11-M6	STAUFF SWG: Stud Welding System	Cable Tie Holder	93
SWG-CTH-30-M6-1	STAUFF SWG: Stud Welding System	Cable Tie / Tension Belt Holder	93
SWG-CTH-30-M6-2	STAUFF SWG: Stud Welding System	Cable Tie / Tension Belt Holder	93
SWG-DIP	STAUFF SWG: Stud Welding System	Distance Plate for DIN 3015 Clamps	93
SWG-GC	STAUFF SWG: Stud Welding System	Ground Cable	95
SWG-SF	STAUFF SWG: Stud Welding System	Weld Stud with Female Thread	92
SWG-SR6	STAUFF SWG: Stud Welding System	Stud Retainer	95
SWG-WG	STAUFF SWG: Stud Welding System	Weld Gun - Arc Ignition	94
SWG-WI06	STAUFF SWG: Stud Welding System	Weld Inverter	94
SWG-WI06-Starterkit	STAUFF SWG: Stud Welding System	Starterkit	94
TS	Standard Series according to DIN 3015, Part 1	Mounting Rail	24
TS	Twin Series according to DIN 3015, Part 3	Mounting Rail	57
VK	Standard Series according to DIN 3015, Part 1	Clamp Body - Rectangular Design for Proximity Switches	19
WSP	Standard Series according to DIN 3015, Part 1	Angled Weld Plate	22
ZR	Saddle / Piggyback Clamps	Custom-Designed Saddle / Piggyback Clamps	122
ZR-518	Saddle / Piggyback Clamps	Saddle / Piggyback Clamp	122



Global Contact Directory

STAUFF products and services are globally available through wholly-owned subsidiaries and a tight network of authorised distributors and representatives in all major industrial regions of the world.

Contact information on this page may be subject to changes and additions over time. Frequently updated and complete contact information can always be found at www.stauff.com.

Germany



Walter Stauffenberg GmbH & Co. KG
Im Ehrenfeld 4
58791 Werdohl
www.stauff.com/contact

www.stauff.com



Neuenrade-Küntrop Logistics Centre
Wasserburgstraße 35
58809 Neuenrade



Plettenberg-Ohle Production Site
Lennastraße 2
58840 Plettenberg



Meinerzhagen Production Site
Neugrünenthal
58540 Meinerzhagen



Meinerzhagen Production Site
Am Rottland 7
58540 Meinerzhagen



STAUFF Digital
Phoenixplatz 3
44263 Dortmund

Europe

France

STAUFF S.A.S.
230, Avenue du Grain d'Or
Z.I. de Vineuil - Blois Sud
41354 Vineuil-cedex
Tel.: +33 2 54 50 55 50
Fax: +33 2 54 42 29 19
E-Mail: direction@stauffsa.com
www.stauff.fr

Ireland

STAUFF UK Ltd.
Block B, 9 Ferguson Drive
Knockmore Hill Industrial Estate
Lisburn, County Antrim, BT28 2EX
Tel.: +44 2892 60 69 00
Fax: +44 2892 60 26 88
E-Mail: sales@stauffireland.com
www.stauff.co.uk

Italy

STAUFF Italia s.r.l
Via Borima 21 (Frazione Borima)
23867 Suello (LC)
Tel.: +39 031 65 84 94
Fax: +39 031 65 50 05
E-Mail: sales@stauff.it
www.stauff.it

Poland

STAUFF Polska Sp. z o.o.
Miszewko 43 A
80-297 Banino
Tel.: +48 58 660 11 60
Fax: +48 58 629 79 52
E-Mail: sales@stauff.pl
www.stauff.pl

Russian Federation

STAUFF LLC
Building 1
19, Leninskaya Sloboda
Moscow, 115280
Tel.: +7 495 276 16 50
Fax: +7 495 276 16 51
E-Mail: sales@stauff.ru
www.stauff.ru

United Kingdom

STAUFF UK Ltd.
500, Carlisle Street East
Off Downgate Drive
Sheffield, S4 8BS
Tel.: +44 114 251 85 18
Fax: +44 114 251 85 19
E-Mail: sales@stauff.co.uk
www.stauff.co.uk

STAUFF UK Ltd.
Badentoy Avenue
Badentoy Industrial Estate
Portlethen, Aberdeen, AB12 4YB
Tel.: +44 1224 78 61 66
Fax: +44 1224 78 61 77
E-Mail: sales@stauffscotland.co.uk
www.stauff.co.uk

STAUFF UK Ltd.
Unit 9, Southampton Trade Park
Third Avenue, Millbrook
Southampton, SO15 0AD
Tel.: +44 2380 69 87 00
Fax: +44 2380 69 87 01
E-Mail: sales@stauffsouthampton.co.uk
www.stauff.co.uk

Further branch offices in
Engels, Volzhskiy, Magnitogorsk,
Nizhny Novgorod and St. Petersburg.



Global Contact Directory

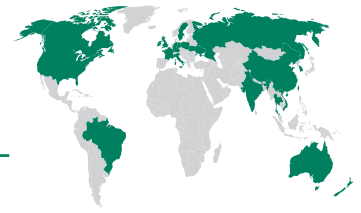

North America

Canada

STAUFF Canada Ltd.
866 Milner Avenue
Scarborough
Ontario M1B 5N7
Tel.: +1 416 282 46 08
Fax: +1 416 282 30 39
E-Mail: sales@stauffcanada.com
www.stauffcanada.com

United States

STAUFF Corporation
7 Wm. Demarest Place
Waldwick, 07463-1542
New Jersey
Tel.: +1 201 444 78 00
Fax: +1 201 444 78 52
E-Mail: sales@stauffusa.com
www.stauffusa.com

Further branch office in
Canton, Michigan.

South America

Brazil

STAUFF Brasil Ltda.
Avenida Gupê 10767
Galpão 2 - Bloco A
Barueri, São Paulo, CEP 06422-120
Tel.: +55 11 47 72 72 00
Fax: +55 11 47 72 72 10
E-Mail: stauff@stauffbrasil.com
www.stauffbrasil.com

Asia

China

STAUFF CHINA
Building 8, No. 1698, Minyi Road
Songjiang District,
Shanghai, 201612
Tel.: +86 21 68 18 70 00
Fax: +86 21 68 18 71 36
E-Mail: info@stauff.com.cn
www.stauff.com.cn

Further branch offices in Beijing,
Changsha, Chengdu, Changchun,
Chongqing, Jinan, Harbin, Guangzhou,
Shenyang, Wuhan, Xian and Xuzhou.

India

STAUFF India Pvt. Ltd.
Gat no. 26/1 & 27, Sanghar Warehousing
Pune - Nagar Road
Lonikand - 412216
Tel.: +91 20 6731 4900
Fax: +91 20 6731 4905
E-Mail: sales@stauffindia.com
www.stauffindia.com

Korea

STAUFF Korea Ltd.
105, Hwajeonsandan 5-ro
Gangseo-gu
Busan, 46739
Tel.: +82 51 266 6666
Fax: +82 51 266 8866
E-Mail: info@stauff.co.kr
www.stauff.co.kr

Singapore

STAUFF (SEA) Pte. Ltd.
128 Joo Seng Road #02-01
Singapore 368356
Tel.: +65 62 44 61 68
E-Mail: sales_sg@stauff.com
www.stauff.com.sg

Thailand

STAUFF (Thailand) Co., Ltd.
10 Soi On-Nut 74/4
Pravet District
Bangkok 10250
Tel.: +66 2 721 73 23 / 24
Fax: +66 2 721 73 35
E-Mail: sales@stauff.co.th
www.stauff.co.th

Vietnam

STAUFF Vietnam Ltd.
2nd Floor, CT-IN Building
#435 Hoang Van Thu Street
Tan Binh District, Ho Chi Minh City
Tel.: +84 8 3948 10 41 / 42
Fax: +84 8 3948 10 44
E-Mail: sales@stauff.com.vn
www.stauff.com.vn

Oceania

Australia

STAUFF Corporation Pty Ltd
24-26 Doyle Avenue
Unanderra NSW 2526
Tel.: +61 2 4271 9000
Fax: +61 2 4271 8432
E-Mail: sales@stauff.com.au
www.stauff.com.au

Further branch offices in
Adelaide, Brisbane, Melbourne
and Sydney.

New Zealand

STAUFF Corporation (NZ) Ltd.
Unit D, 103 Harris Road
East Tamaki, Auckland 2013
Tel.: +64 9 912 1530
Fax: +64 9 912 1531
E-Mail: sales@stauff.co.nz
www.stauff.co.nz



Introduction

Standard Series according to DIN 3015, Part 1

Heavy Series according to DIN 3015, Part 2

Twin Series according to DIN 3015, Part 3

Heavy Twin Series

STAUFF ACT Clamps: Anti-Corrosion Technology

STAUFF SWG: Stud Welding System

STAUFF Bond: Adhesive Bonded Fastening

Custom-Designed Special Clamps

Light Series

Saddle / Piggyback Clamps

Flat Steel and Round Steel U-Bolt Clamps

Metal DIN Clamps

Construction Series

Other Types of Clamps

Technical Appendix

Appendix



Catalogue 1 STAUFF Clamps

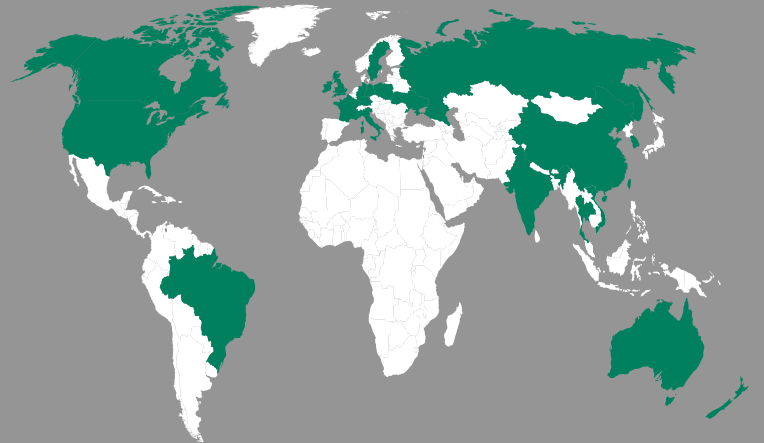

Germany

Walter Stauffenberg GmbH & Co. KG
Im Ehrenfeld 4
58791 Werdohl

STAUFF products and services are globally available through wholly-owned subsidiaries and a tight network of authorised distributors and representatives in all major industrial regions of the world.

Contact STAUFF:

www.stauff.com/contact